

# TROPEA

## TDL 346

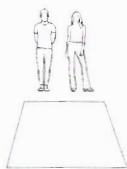



**EN: Damages during assembly:**

These can be avoided if you use a clean soft surface (e.g. carpet). Only place parts on a soft surface when unpacking or during the assembly. Make sure that larger parts can not tip over.

**DE: Montageschäden:**

Vermieden Sie, indem Sie einen sauberen und weichen Untergrund verwenden (z. B. Teppich). Teile beim Auspacken oder während der Montage nur auf weiche Unterlagen legen/stellen. Darauf achten, dass grössere Teile nicht kippen können.

**DK: Skader under montering**

Disse kan undgåes, hvis du bruger en ren og blød overflade (fx et tæppe). Placer delene på en blød overflade ved udpakning og montering. Sørg for, at større dele ikke kan vælte.

**NL: Beschadigenen tijdens montage:**

Deze kunnen vermeden worden wanneer u een proper zacht oppervlak (bv. tapijt) gebruikt. Plaats enkel onderdelen op een zacht oppervlak bij het uitpakken of tijdens de montage. Zorg ervoor dat grotere onderdelen niet kunnen ontkantelen.

**FR: Dommages lors du montage:**

Évitez les dommages en utilisant un fond propre et doux (p.ex. tapis). Lors du déballage et montage, posez les éléments uniquement sur un fond doux. Assurez-vous que les grands éléments ne peuvent pas basculer.

**ES: Daños durante el ensamblaje:**

Se pueden evitar si utiliza una superficie limpia y suave (p. ej., una alfombra). Únicamente ubique las piezas en la superficie suave cuando esté desempacándolas o durante el ensamblaje. Asegúrese de que las partes más grandes no se puedan dar vuelta.



**EN: People:**  
Two people are required for the assembly.

**DE: Personen:**  
Für die Montage erforderliche Anzahl Personen.

**DK: Personer:**  
Til montering skal der bruges to personer

**NL: Personen:**  
Aantal personen vereist voor de montage.

**FR: Personnes:**  
Nombre de personnes nécessaires au montage.

**ES: Personas:**  
Cantidad de personas necesarias para el ensamblaje.

**EN: Tools required:**  
**NL: Benodigde gereedschappen:**



**DE: Benötigtes Werkzeug:**  
**FR: Outils nécessaires:**



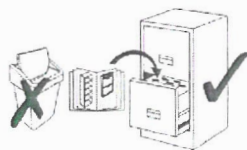
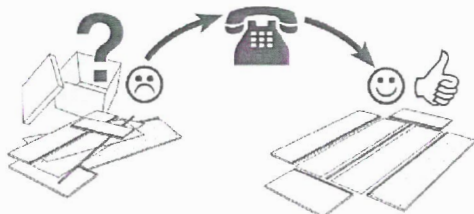

**DK: Nødvendige værktøjer:**  
**ES: Herramientas necesarias:**



EN: How to mount the legs  
 NL: Hoe de poten monteren

DE: Montage der Beine  
 FR: Pour monter les pieds

DK: Montering af ben  
 ES: Cómo armar las patas

	 <b>A</b> 31157	 <b>B</b> M8x25	 <b>C</b> L5 Key
Item number	53311570040	932000681	932000200
All 3-seaters and corners	4	12	1
Pouf	4	16	2

EN: Attention: Transport plate needs to be unmounted before use.  
 DE: Achtung: Die Montageplatte muss vor der Verwendung demontiert werden.  
 DK: OBS: Transportplader skal afmonteres før brug.  
 NL: Aandacht: De transportplaat moet vóór gebruik worden gedemonteerd.  
 FR: Attention: La planche de transport doit être démontée avant l'utilisation.  
 ES: Atención: Es necesario desmontar la placa de transporte antes del uso.

EN: Fittings inside.  
 DE: Beschläge innen.  
 DK: Beslag indeni.  
 NL: Fittingen binnen.  
 FR: Raccords à l'intérieur.  
 ES: Herrajes dentro.

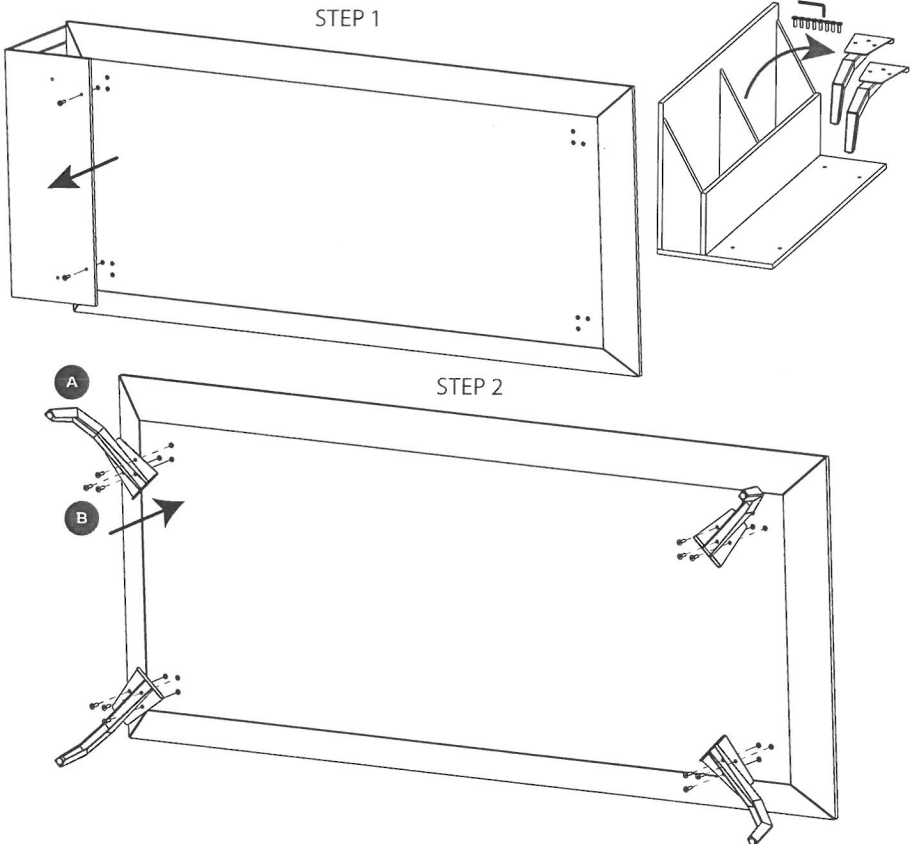

EN: Where to position the legs depends on configuration.

DK: Placering af benene afhænger af konfiguration.

FR: Position des pieds en fonction de la configuration.

DE: Position der Beine, abhängig von der Konfiguration.

NL: Waar de poten te plaatsen is afhankelijk van de configuratie.

ES: Dónde ubicar las patas según la configuración.

Footrest

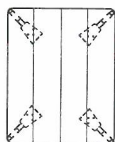

3-seater

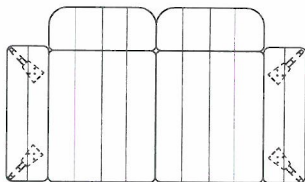

3-seater (one arm)+footrest

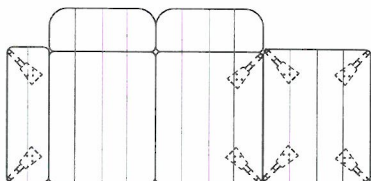

3-seater+corner (no arms)

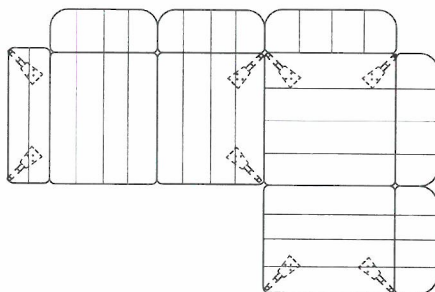

3-seater+corner (one arm)

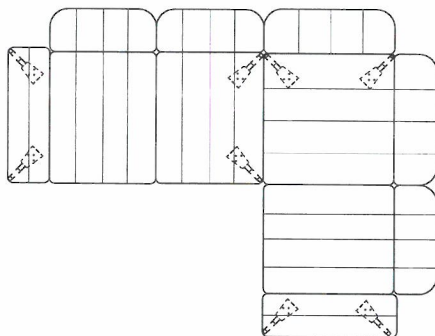

3-seater+corner (no arms)+footrest

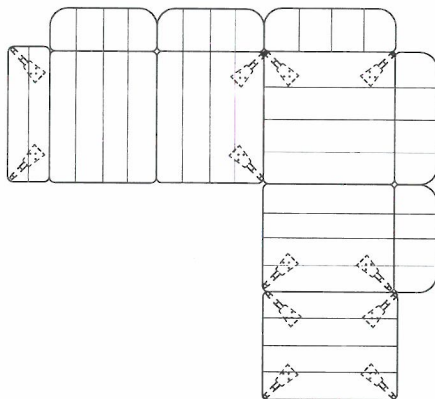

EN: How to attach the back cushion

DK: Sådan fastgøres rygpuden

FR: Comment attacher le coussin de dossier

DE: So befestigen Sie das Rückenkissen

NL: Hoe het rugkussen te bevestigen

ES: Cómo colocar el cojín del respaldo

	<b>D</b>  M8x40	<b>C</b>  L5 Key
Item number	932000285	932000200
3-seaters	8	1
All corners	12	1

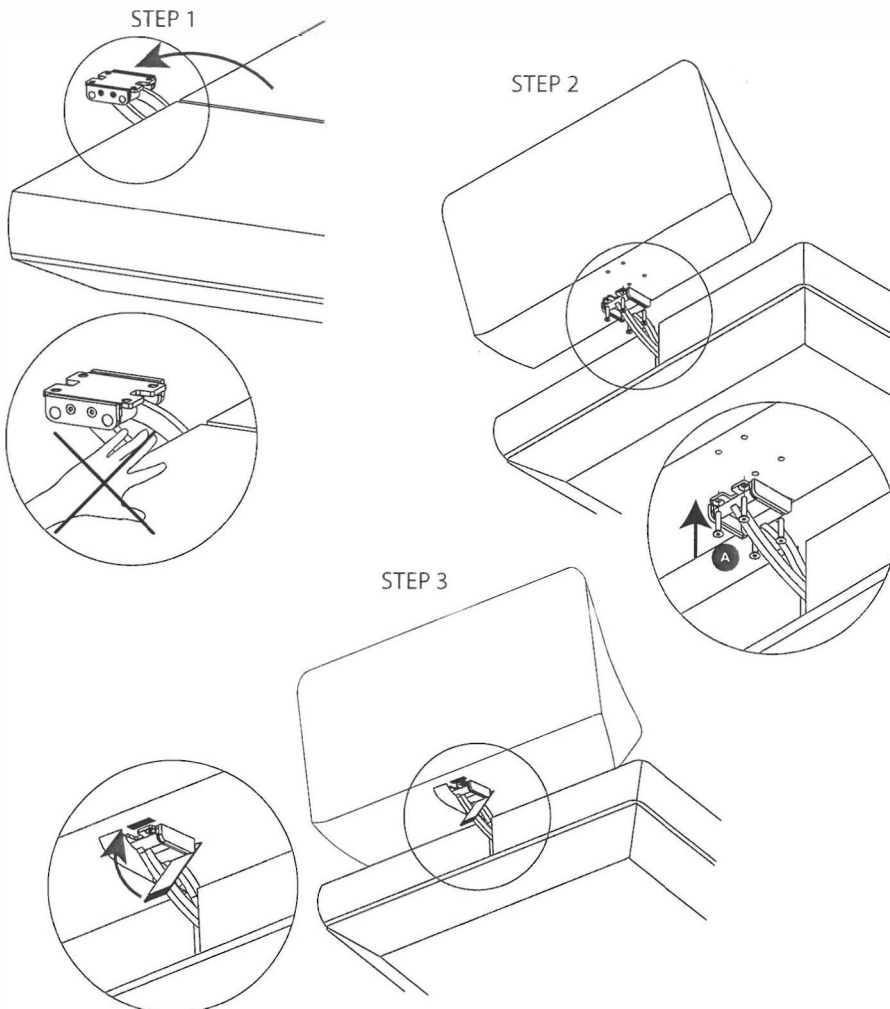

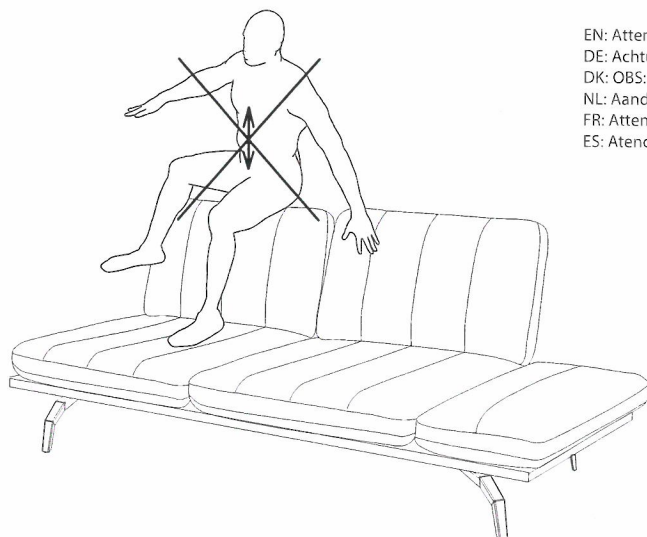

EN: Attention: Do not sit down.  
DE: Achtung: Setzen Sie sich nicht hin.  
DK: OBS: Sæt dig ikke.  
NL: Aandacht: Niet gaan zitten.  
FR: Attention: Ne vous asseyez pas.  
ES: Atención: No sentarse.

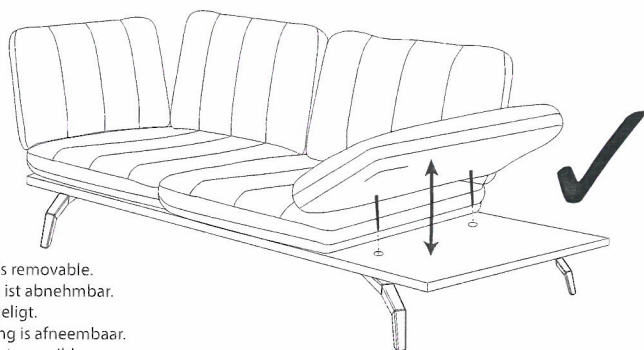
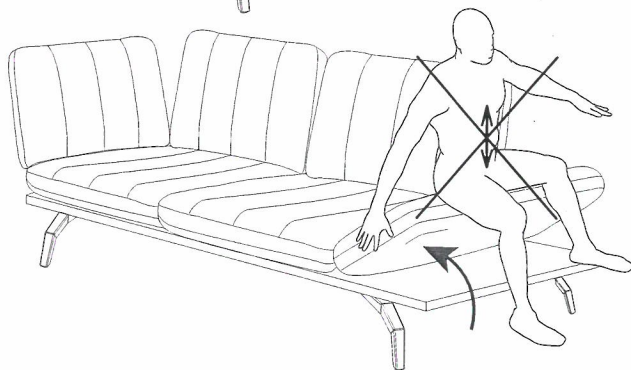





EN: Attention: The armrest is removable.  
DE: Achtung: Die Armlehne ist abnehmbar.  
DK: OBS: Armlænet er aftageligt.  
NL: Aandacht: De armleuning is afneembaar.  
FR: Attention: L'accoudoir est amovible.  
ES: Atención: El reposabrazos es extraíble.

EN: How to connect the modules.  
 NL: Hoe de modules verbinden.

DE: Verbinden der Module.  
 FR: Pour raccorder les modules.

DK: Samling af moduleerne  
 ES: Cómo conectar los módulos

			 M8x25	 L5 Key
Item number	932000790		932000681	932000200
Corner / Footrest	1	1	4	1

3-seater+ corner (one arm)

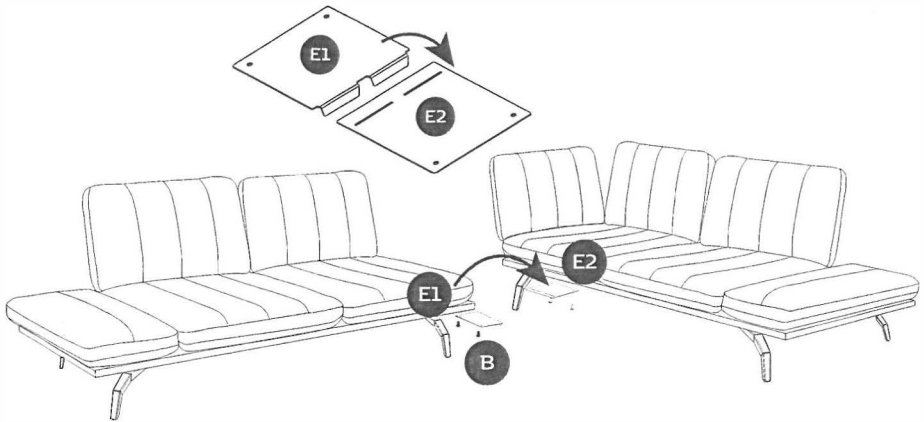

Corner (no arms)

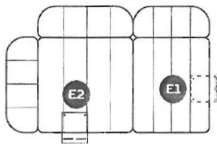

Corner (one arm)

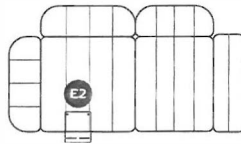

3 seater (one arm)

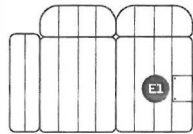

Footrest

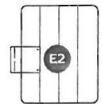

**FR**

 **Pensez à donner ou recycler.**

 OU  OU 

**ASSOCIATION LIVRAISON OÛCHÈTERIE**

<https://quefairedemesdechets.fr>

  **FR**

[quefairedemesdechets.fr](https://quefairedemesdechets.fr)