

Art:161

SAMLEVEJLEDNING
ASSEMBLY INSTRUCTIONS
BAUANLEITUNG
MONTAGE HANDLEIDING
ISTRUZIONI DI MONTAGGIO
NOTICE DE MONTAGE

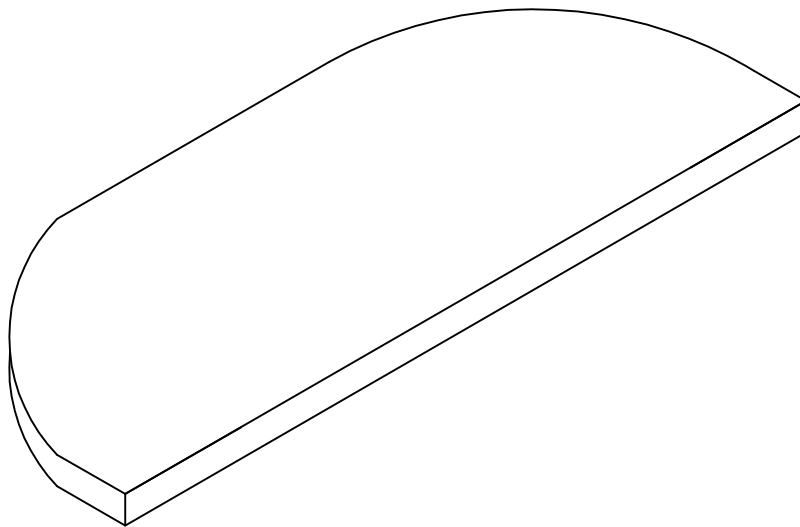

VIGTIGT !

IMPORTANT !

WICHTIG !

BELANGRIJK !

IMPORTANTE !

IMPORTANT !

DK / Før du starter. Læs venligst denne instruktion grundig igennem og opbevar denne til evt. senere brug. Sørg for at plastikposer ikke kommer i små børns hænder og vær sikker på, at der ikke er små børn i nærheden, under montagen, da der er små dele i pakken.

UK / Before you start. Please read instructions carefully and retain for future reference. Please dispose carefully of packing materials. Keep plastic bags away from small children. Ensure small children are kept clear during assembly as this pack contains small parts.

D / Bevor Sie anfangen, lesen Sie bitte diese Bauanleitung sorgfältig durch und bewahren Sie diese für späteren Gebrauch auf. Sichern Sie sich, dass die Plastiktüten nicht in den Händen von kleinen Kindern kommen, und auch dass keine kleinen Kinder beim aufbauen in der Nähe sind weil die Verpackung kleine Teile beinhaltet.

NL / Voordat u begint, leest u alstublieft de montage handleiding aandachtig door en bewaar deze zorgvuldig. Plastic verpakkingsmateriaal weghouden bij jonge kinderen. Wees er zeker van dat tijdens het monteren van het bed de kinderen op een veilige afstand zijn, omdat de verpakking kleine onderdelen bevat.

IT/ Prima di iniziare. Si prega di leggere attentamente le istruzioni e di conservarle per un uso successivo. Tenere lontano dalla portata dei bambini il pacchetto perché contiene piccole parti di assemblaggio e fare attenzione a non lasciarle in giro.

F/ Avant de commencer. Veuillez lire cette notice soigneusement et pensez à la garder pour une utilisation ultérieure. Veuillez à ne pas laisser les sachets plastiques accessibles aux enfants, et à éloigner les enfants pendant le montage car présence de petits objets dans les colis .

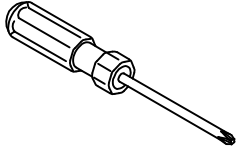
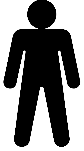

Art 161

Colli: 1 = 161

10161 x 1

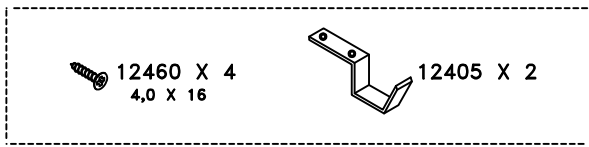

161

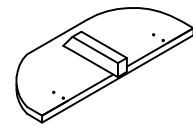

35161 X 1

12460 X 4
4,0 X 16

1

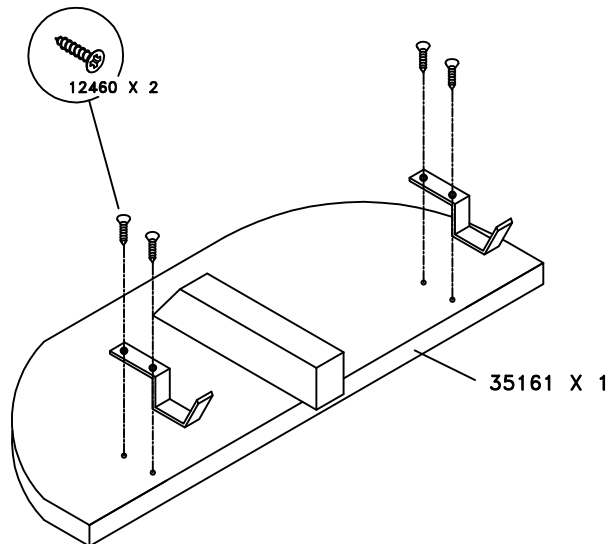



From the finest forrest in Sweden, to the **high quality** production in **Denmark**. From **experinced** designers, to lots of **safety** tests and plenty of approvals from **kids** them selves. LIFETIME Kidsroom is proud to introduce you to our quality furniture created **since 1972**.

Fra de fineste skove i Sverige, til den **kvalitetshøje** produktion i **Danmark**. Fra **erfarne** designere, til utallige **sikkerhedsteste** og flere godkendelser fra **børnene** selv. LIFETIME Kidsroom er stolte af at kunne introducere jer til vores kvalitetsmøbler produceret **siden 1972**.



Von den feinsten Wäldern in Schweden bis zur **hochwertigen** Produktion in **Dänemark**. Von erfahrenen Designern über viele **Sicherheitstests** und Genehmigungen, auch von **Kindern** selbst. LIFETIME Kidsrooms ist stolz darauf, Ihnen unsere qualitativ hochwertigen Möbel **seit 1972** vorzustellen.

Van de beste bosbouw in Zweden naar **hoogwaardige** productie in **Denemarken**. Van ervaren designers naar veelvuldige **veiligheidstesten** en goedkeuring van heel veel **kinderen**. LIFETIME Kidsrooms is trots u zijn hoogwaardige meubelen, gecreëerd **sinds 1972**, te presenteren.

Dalla splendida foresta Svedese alla produzione di **alta qualità** Danese. Da progettisti con **esperienza** ad innumerevoli test di **sicurezza** e la piena approvazione dei **bambini** stessi. LIFETIME Kidsrooms è orgogliosa di presentarvi la nostra linea di camerette, prodotta con attenzione alla qualità dal **1972**.

Des plus belles forêts suédoises à la **meilleure qualité** de production au **Danemark**. De **l'expérience** des designers aux tests de **sécurité**, et beaucoup d'avis favorables de la part des **enfants** eux-mêmes. LIFETIME chambres pour enfants est fière de vous présenter ses meubles de qualité créés en **1972**.



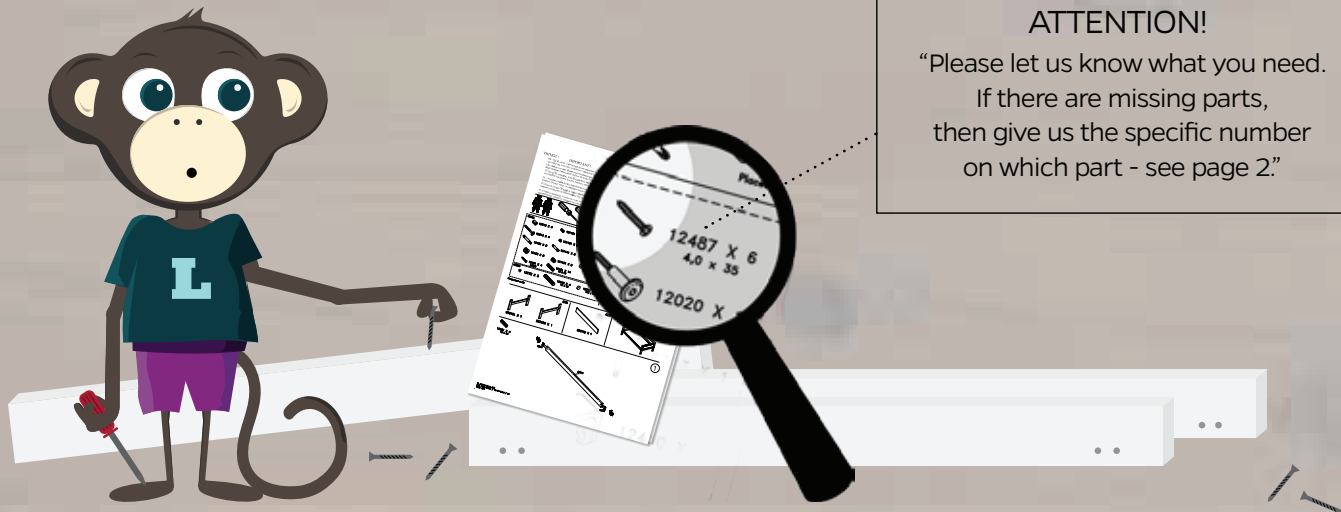

ATTENTION!
 "Please let us know what you need.
 If there are missing parts,
 then give us the specific number
 on which part - see page 2."



DK LIFETIME BESTRÆBER SIG ALTID EFTER AT LEVERE DEN BEDSTE KVALITET. SKULLE DER MOD FORVENTNING OPSTÅ EN REKLAMATION, BEDES DE VENLIGST UDFYLDE DENNE BLANKET, OG AFLEVERE DEN TIL LIFETIME FORHANDLEREN / **UK** LIFETIME ALWAYS STRIVES TO PROVIDE THE BEST QUALITY. IN THE UNLIKELY SITUATION OF A CLAIM, PLEASE FILL OUT THIS FORM AND HAND IT OVER TO THE LIFETIME DEALER WHERE YOU BOUGHT YOUR LIFETIME FURNITURE / **D** LIFETIME BEMÜHT SICH IMMER DIE BEST MÖGLICHE QUALITÄT ZU LIEFERN. SOLLTE GEGEN ALLER ERWARTUNG DENNOCH EIN GRUND FÜR EINE REKLAMATION ENTSTEHEN, FÜLLE BITTE FOLGENDES FORMULAR AUS UND REICHE DIES ZUSAMMEN MIT FOTOMATERIAL DEM LIFETIME HÄNDLER BEI DEM SIE DIE LIFETIME MÖBEL ERWORBEN HABEN / **NL** LIFETIME STREEFT ALTIJD NAAR DE BESTE KWALITEIT. MOCHT U EEN KLACHT HEBBEN, VULT U DAN ONDERSTAAND FORMULIER IN EN GEEF HET AAN DE LIFETIME DEALER WAAR U DE LIFETIME MEUBELEN HEEFT GEKOCHT / **IT** LIFETIME CERCA DI FORNIRE SEMPRE LA MIGLIORE QUALITA'. NELLA RARA EVENTUALITA' IN CUI SI PRESENTI UN RECLAMO, VI PREGHIAMO DI COMPILARE QUESTO MODULO E CONSEGNARLO AL VOSTRO RIVENDITORE LIFETIME / **F** LIFETIME S'EFFORCE TOUJOURS DE FOURNIR LA MEILLEURE QUALITE. DANS LA SITUATION PEU PROBABLE D'UNE REKLAMATION, MERCI DE REMPLIR CE FORMULAIRE ET DE LE REMETTRE AU REVENDEUR LIFETIME A QUI VOUS AVEZ ACHETE VOS MEUBLES LIFETIME.



NAME



DATE



ADDRESS



PHONE



MAIL



STORE



ARTICLE NO.

PROBLEM:

DESCRIPTION:

- FAULTS IN LACQUER OR SURFACE TREATMENTS
- FAULTS FROM PRODUCTION (REGARDLESS MATERIAL AS TREE, FABRICS ETC.)
- MISSING OR WRONG PARTS INCLUDING FITTINGS
- DAMAGED PART(S) INCLUDING TRANSPORT DAMAGES
- OTHER CAUSE WHICH CAN NOT BE RELATED TO ABOVE



M. Schack Engel A/S - Højervej 16 - 6280 - Højer - Denmark - +45 7478 2258

www.lifetimekidsrooms.com