

SCHEDA MONTAGGIO

ASSEMBLY INSTRUCTION - AUFBAUANLEITUNG - NOTICE DE MONTAGE



ATTENZIONE:
MANEGGIARE CON MANI PULITE
ATTENTION:
HANDLE WITH CLEAN HANDS
ACHTUNG:
MIT SAUBEREN HÄNDEN ANFASSEN
ATTENTION:
MANIPULER AVEC LES MAINS PROORES

KIT DI MONTAGGIO - ASSEMBLY KIT
MONTAGEZUBEHÖR - KIT DE MONTAGE

A



VITE TSPEI M10x40
M10x40 TSPEI SCREW
SCHRAUBE TSPEI M10x40
VIS TSPEI M10x40

N°4

B



VITE TBEI M8x20
M8x20 TBEI SCREW
SCHRAUBE TBEI M8x20
VIS TBEI M8x20

N°2

C



VITE M4x50
M4x50 SCREW
SCHRAUBE M4x50
VIS M4x50

N°4

D

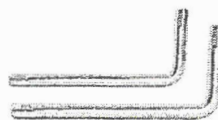

CHIAVE A BRUGOLA 5-6
ALLEN KEY 4-5
IMBUSSCHLÜSSEL 4-5
CLE ALLEN 4-5

N°1+1

1

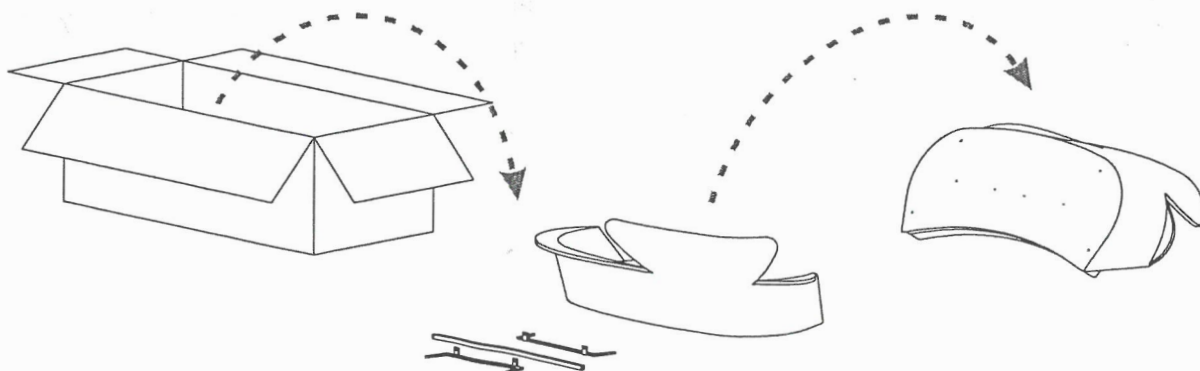

2

DON'T FIX SCREWS

A + D-6

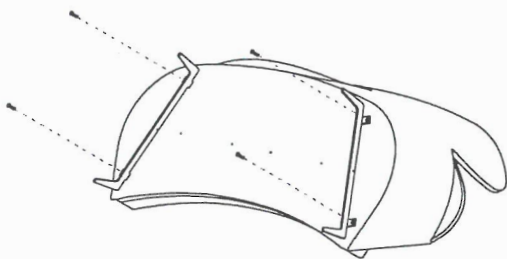

3

DON'T FIX SCREWS

C + 

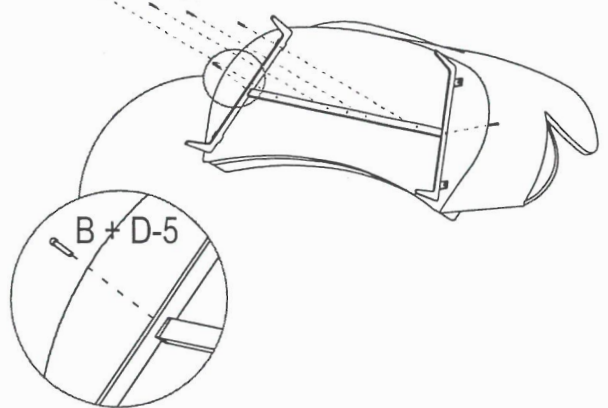

4

FIX ALL SCREWS

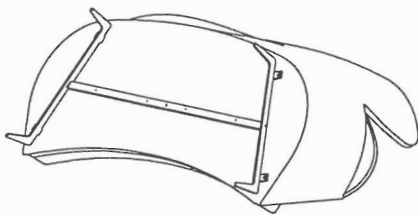

5

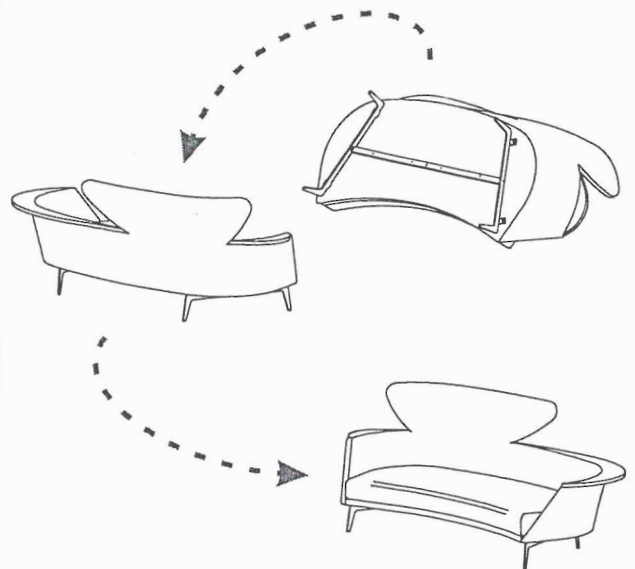

Grazie per aver scelto un prodotto BONALDO.
Thank you for choosing a BONALDO product.
Danke dass Sie ein BONALDO produkt gewählt haben.
Merci d'avoir choisi un produit BONALDO.

BONALDO

Bonaldo Spa
via Straelle, 3 - P.O. Box n.6 - 35010 Villanova Pd Italia
Tel. +39 09 9299011 Fax +39 049 9299000
www.bonaldo.it - bonaldo@bonaldo.it