

SAVONA

10E6--01

Type:01

1 / 12

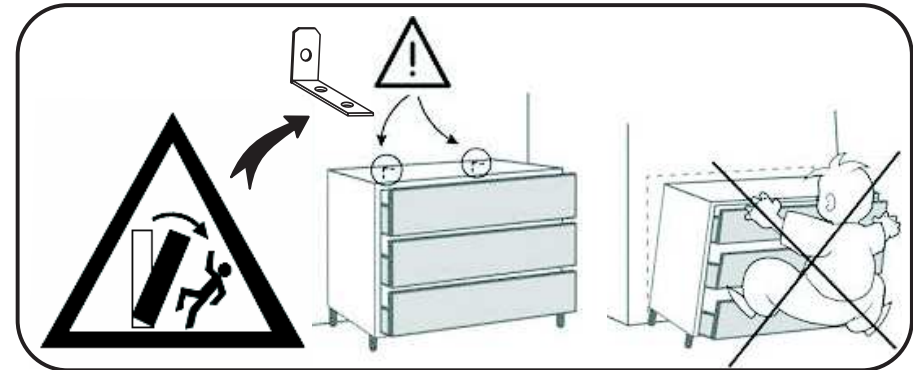
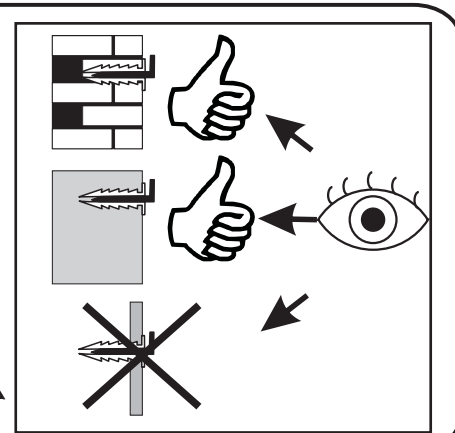
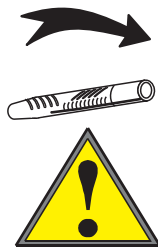
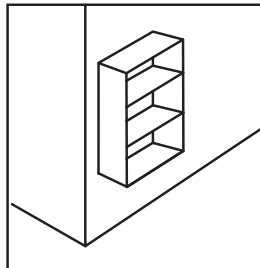
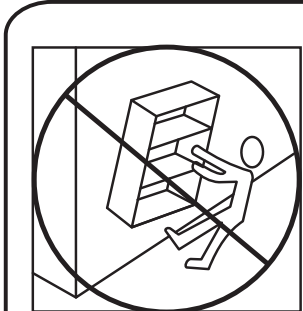
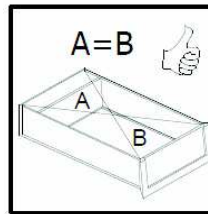
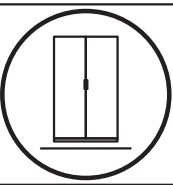
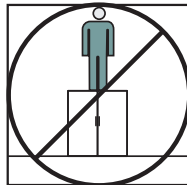
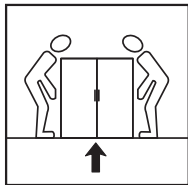
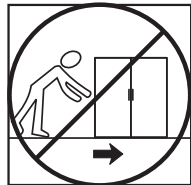
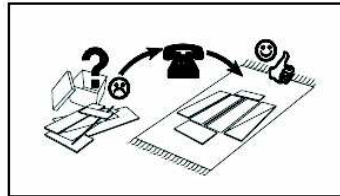
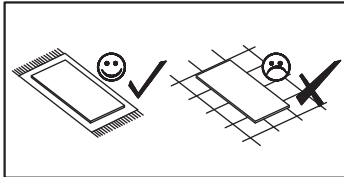
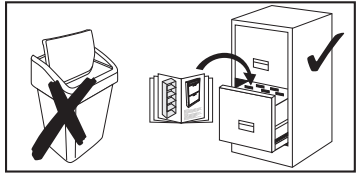
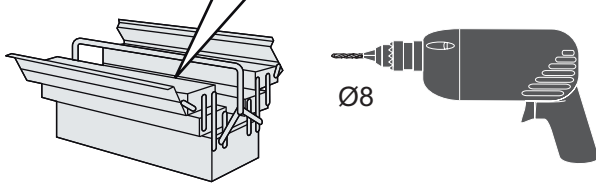
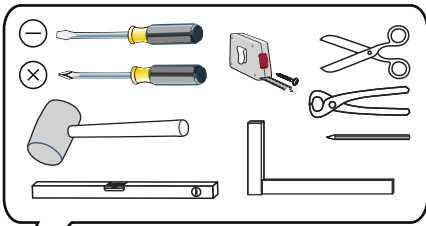
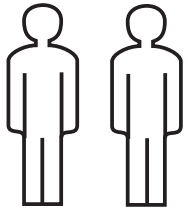

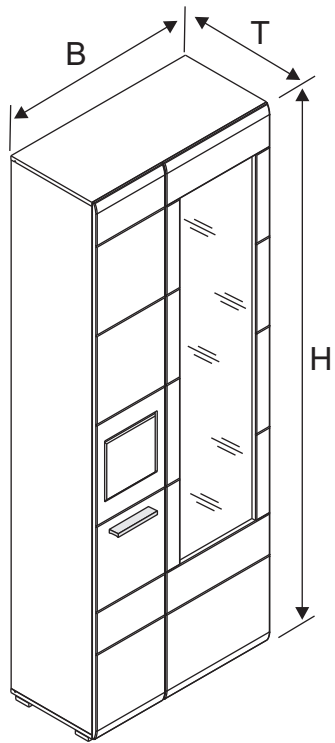

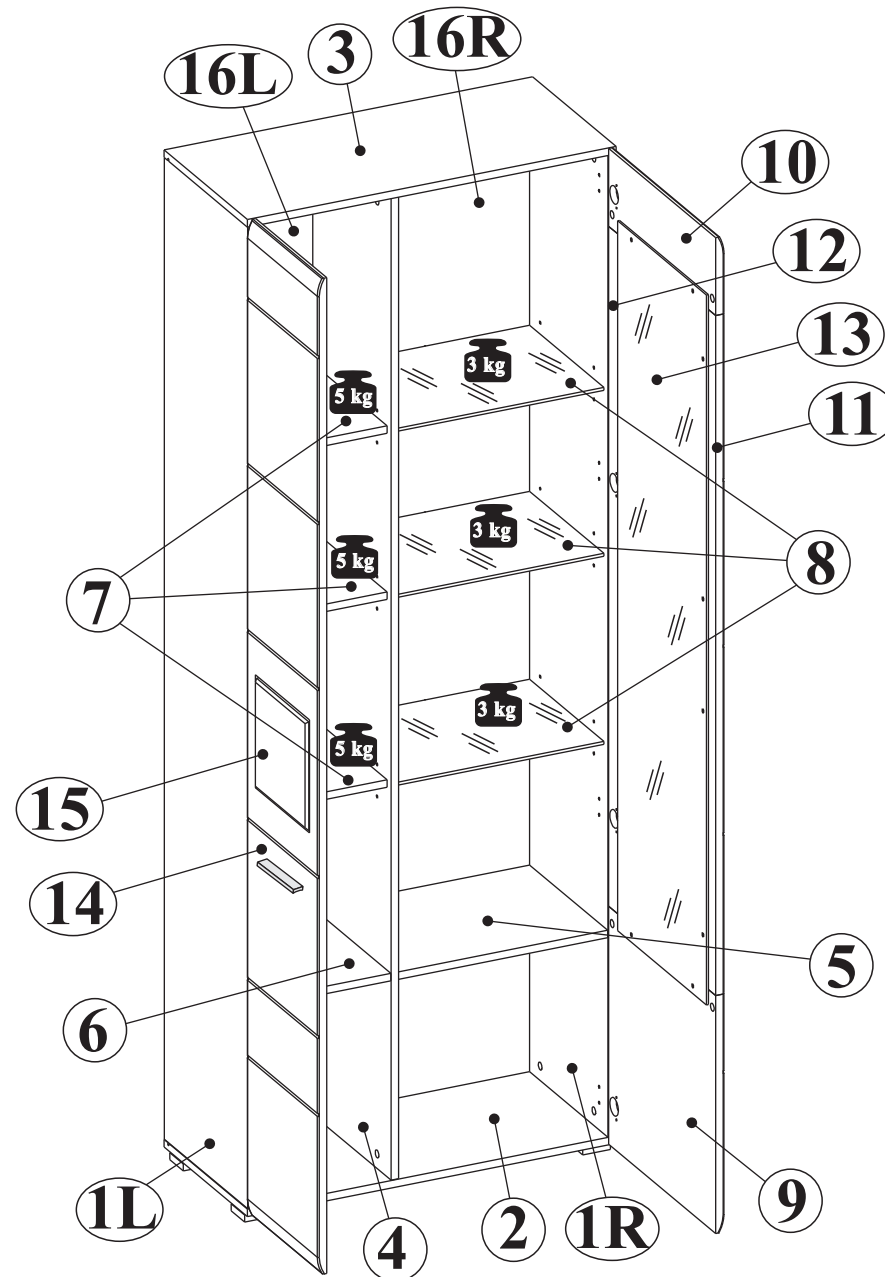

B - 750mm
H - 2014mm
T - 366mm

1L	1964	347	1	2/2
1R	1964	347	1	2/2
2	750	348	1	1/2
3	750	348	1	1/2
4	1964	344	1	2/2
5	426	323	1	1/2
6	277	323	1	1/2
7	277	310	3	1/2
8	425	310	3	1/2
9	476	446	1	1/2
10	156	446	1	1/2
11	1360	60	1	2/2
12	1360	60	1	2/2
13	1420	371	1	2/2
14	1992	296	1	2/2
15	218	218	1	1/2
16L	1973	286	1	2/2
16R	1973	435	1	2/2



NR 1

B1  ϕ 8x28 x16

B20  ϕ 8x50 x6

M1  ϕ 15x12mm x24

T1  5x39mm x20

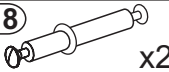
T18  L-64 x2

W1  x12

W2  x12

HOM'IN®
JUNGES EINRICHTEN x1

NR 2

J23  x18

G5  x4

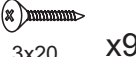
S6  3x20 x9

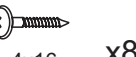
P16  4x16 x8

G4  x8

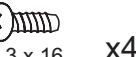
E29  6,3 x 16 x4

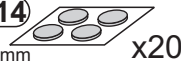
C14  ϕ 20mm x20

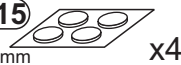
C15  ϕ 20mm x4

NR 3

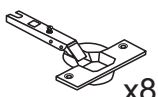
Y0  ϕ 35 x8

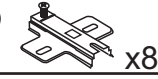
D6  H2 x8

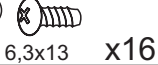
E3  6,3x13 x16

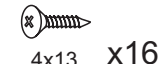
S8  4x13 x16

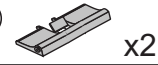
Z5  x2

NR 4

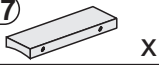
U67  x1

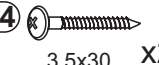
P14  3,5x30 x2

NR 5

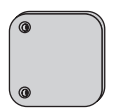
U69  x1

S3  3,5x13 x2

NR 6

N20  x5

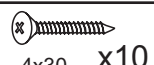
S2  4x30 x10

NR 7

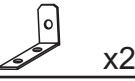
J11  x2

P13  3,5x13 x4

T13  8x50 mm x2

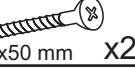
T14  6x50 mm x2

NR 8

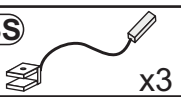
S3S  x3

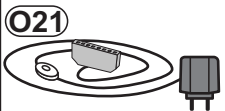
O21  MAX 6W x1



<http://www.innostyle-mvg.de>

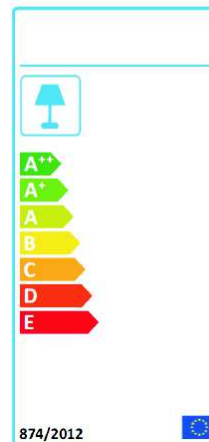

BG	Bulgarisch	български
CS	Tschechisch	čeština
DA	Dänisch	Dansk
DE	Deutsch	Deutsch
ET	Estonisch	Eesti
EL	Griechisch	ελληνικά
EN	English	English
ES	Spanisch	español
FR	Französisch	Français
FI	Finnisch	suomalainen
HR	Kroatisch	hrvatski
HU	Ungarisch	magyar
IT	Italienisch	italiano
LV	Lettisch	Latvijas
LT	Litauisch	Lietuvos
NL	Niederländisch	Nederlands
PL	Polnisch	Polski
PT	Portugiesisch	português
RO	Rumänisch	român
SK	Slowakisch	slovenský
SL	Slovenisch	slovenščina
SV	Schwedisch	Svenska



Möbelvertriebsgesellschaft mbH & Co.



1

T1
5x39mm x4

D6
H2 x8

W1
x12

B1
φ 8x28 x12

E3
6,3x13 x16

W2
x12

M1
φ15x12mm x12

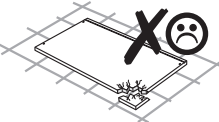
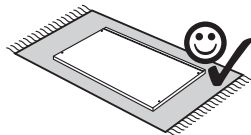
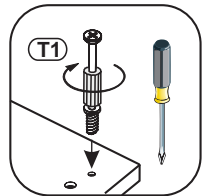
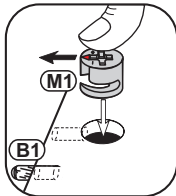
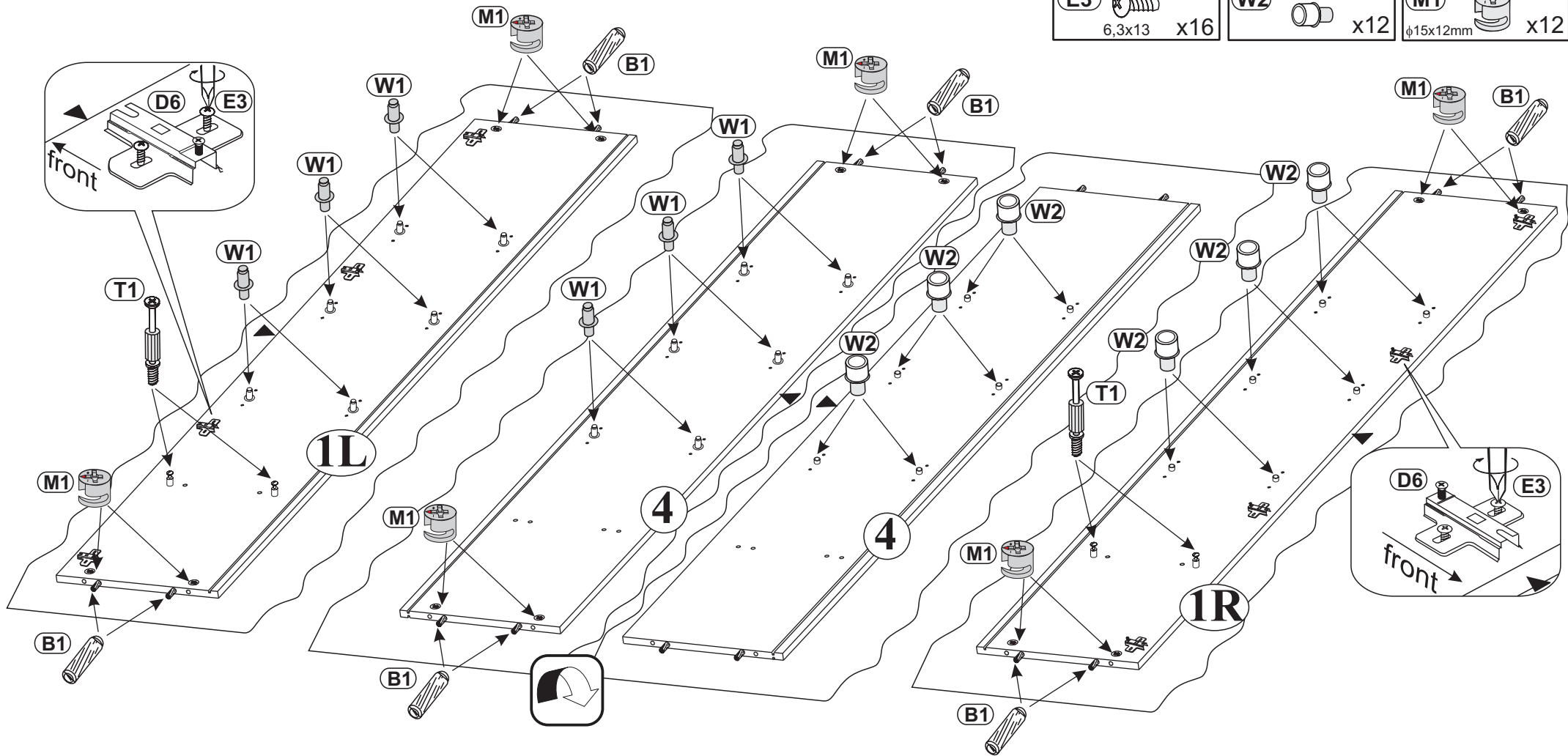

2

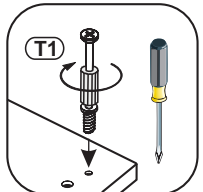
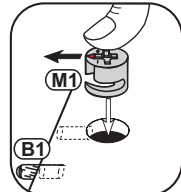
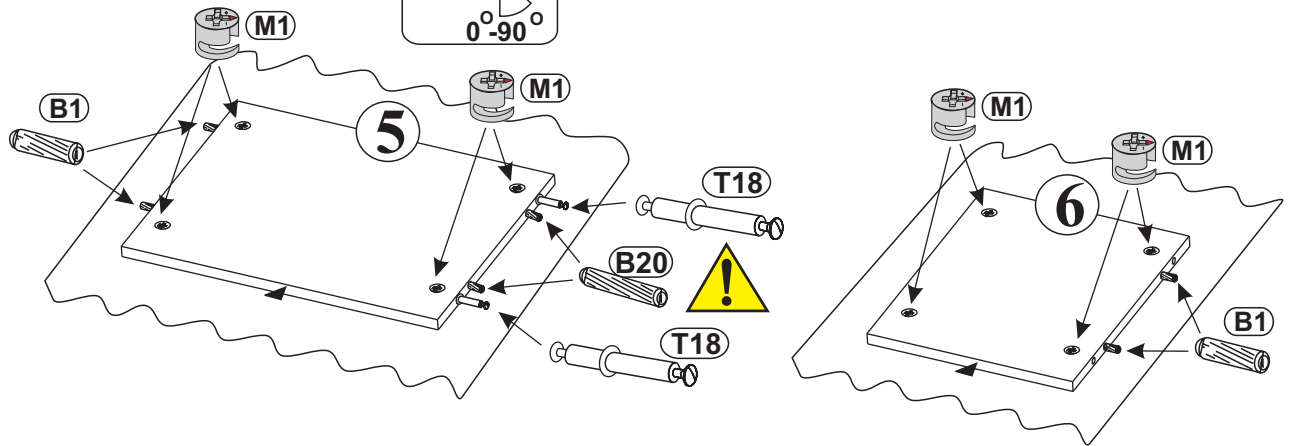
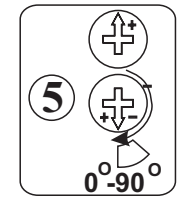
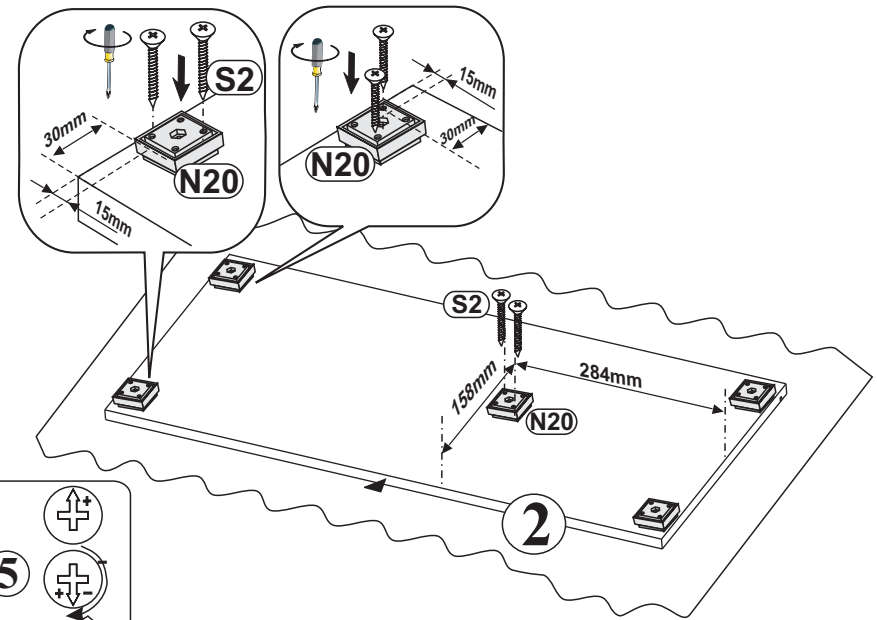
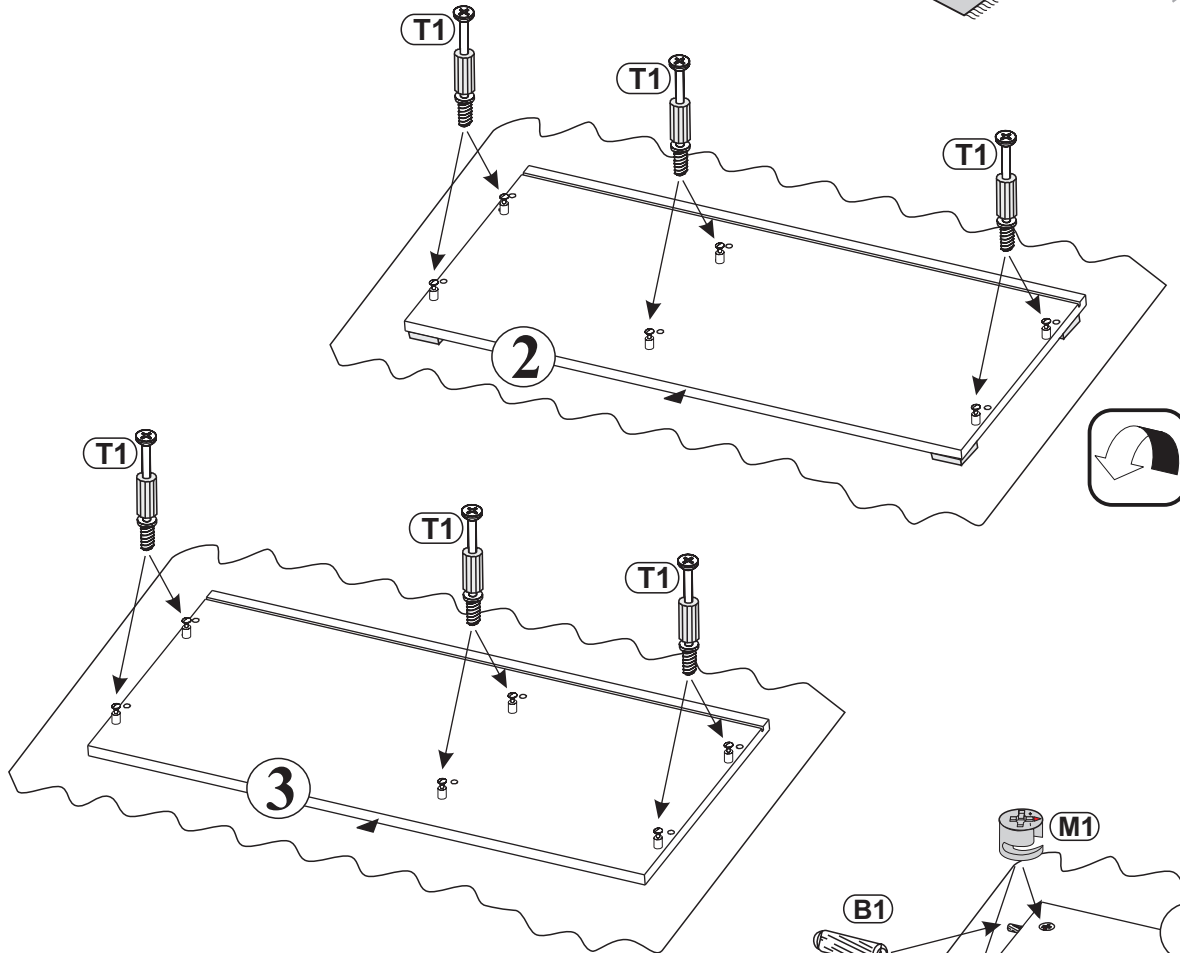
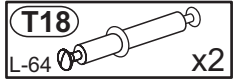
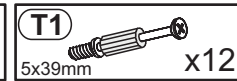
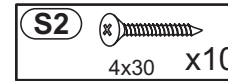
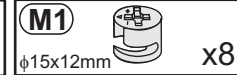
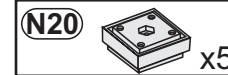
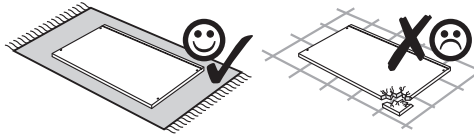

5

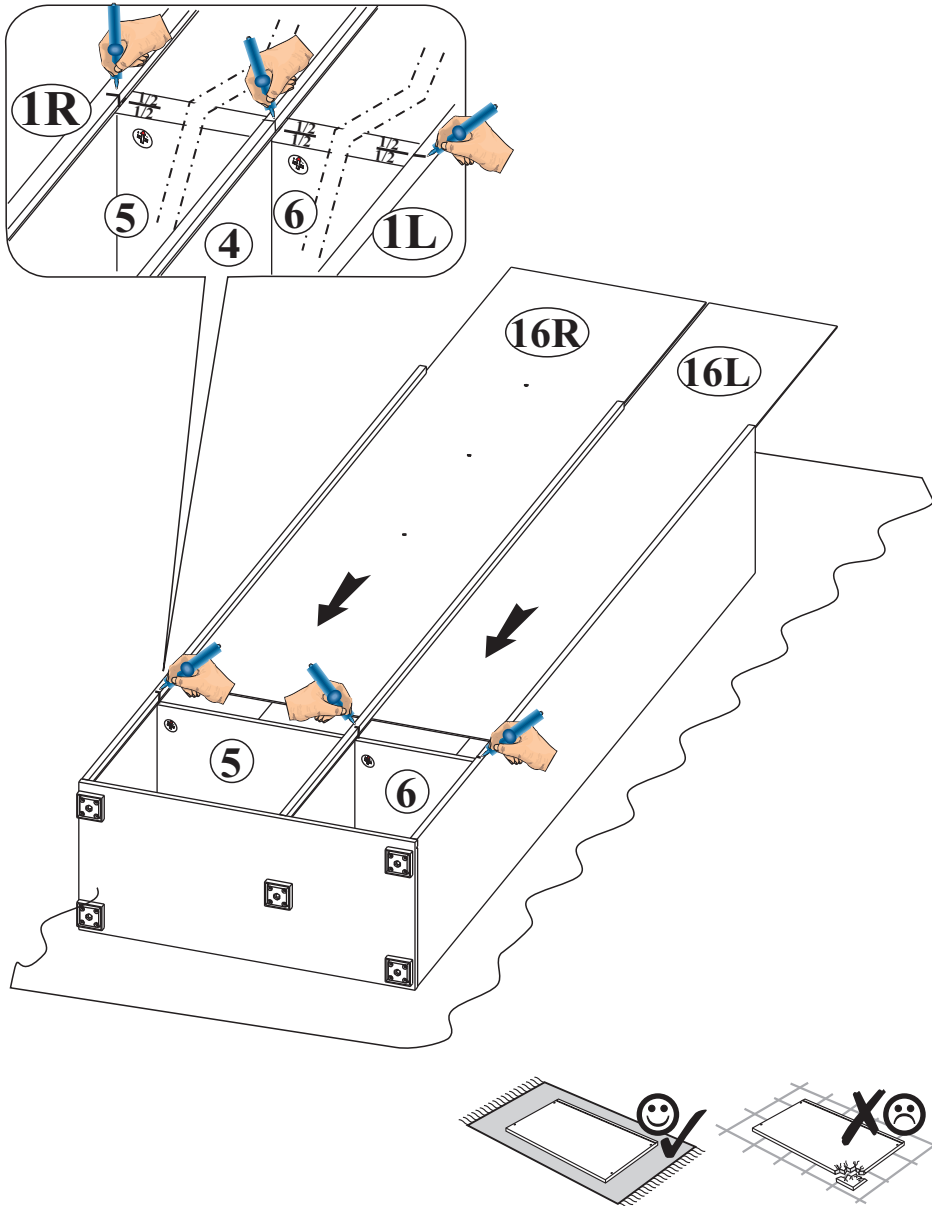

6

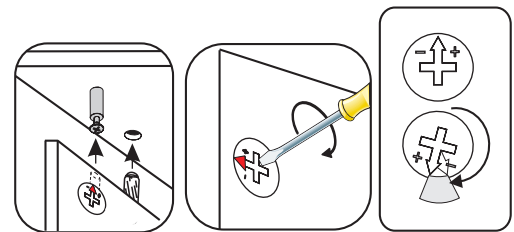
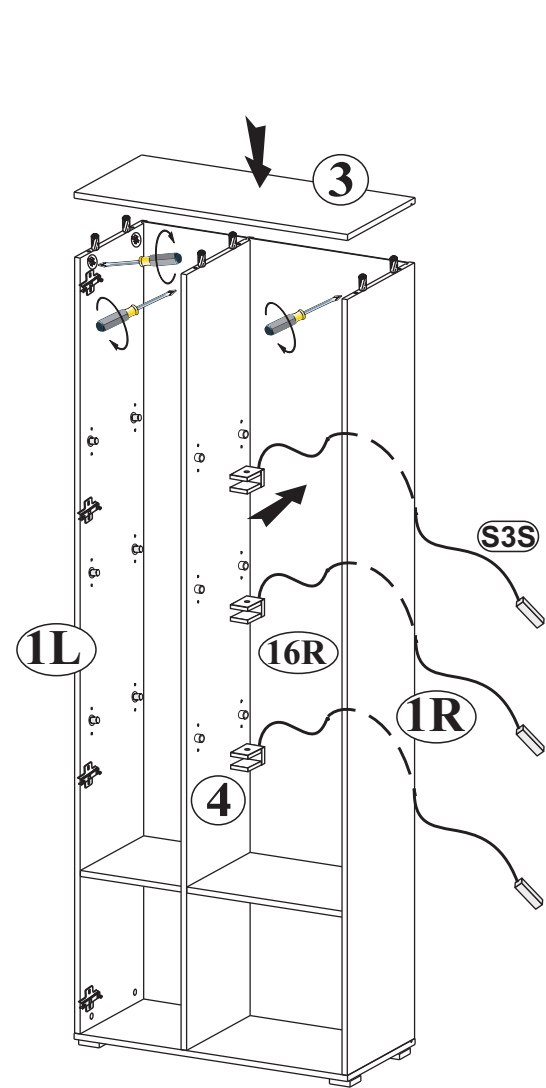

7

J23  x18

S6  3x20 x5

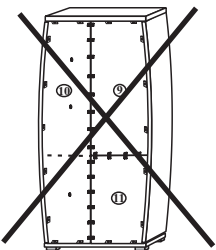
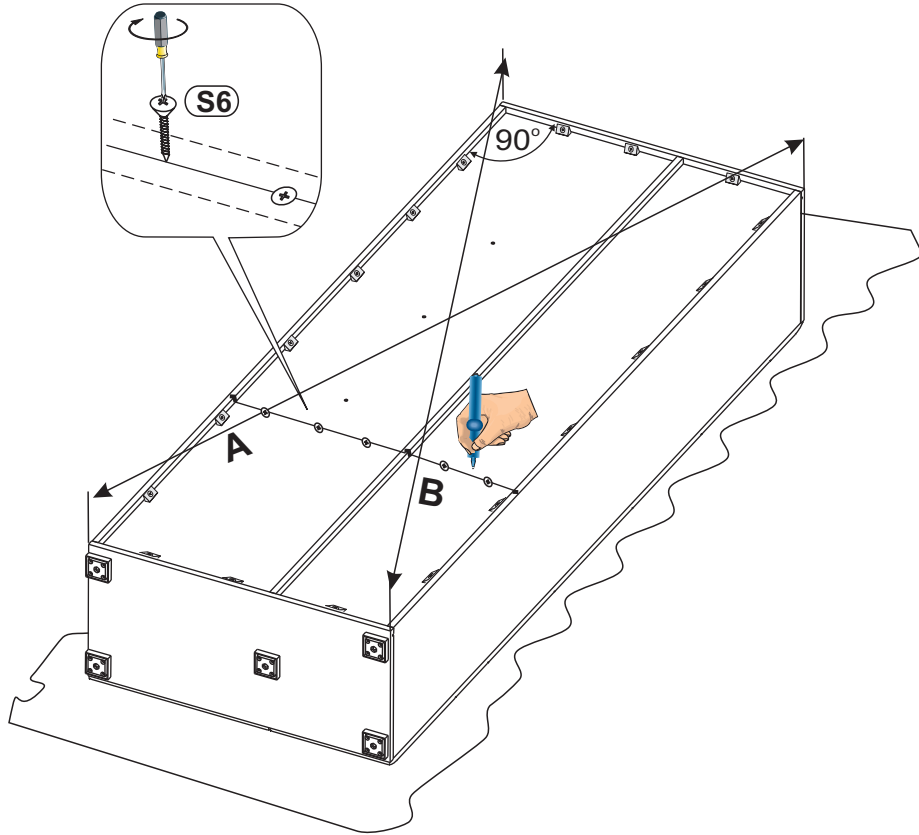

A=B  

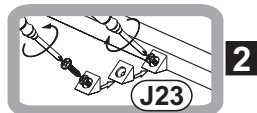
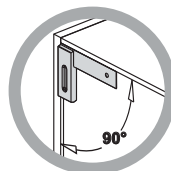

8

J11  x2

P13  3,5x13 x4

T13  8x50 mm x2



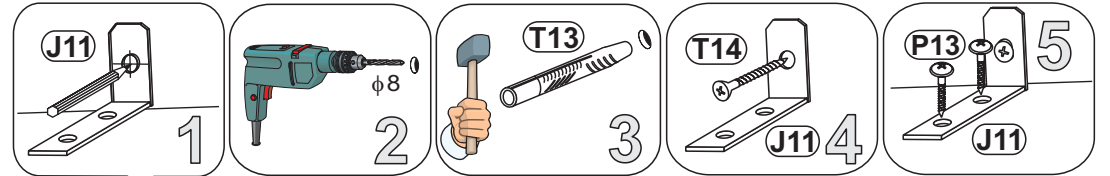

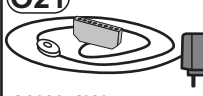

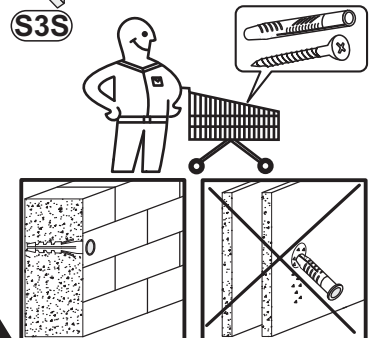
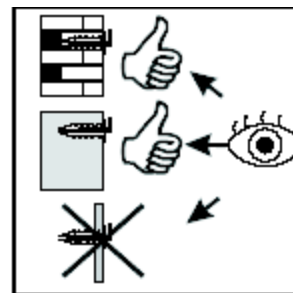
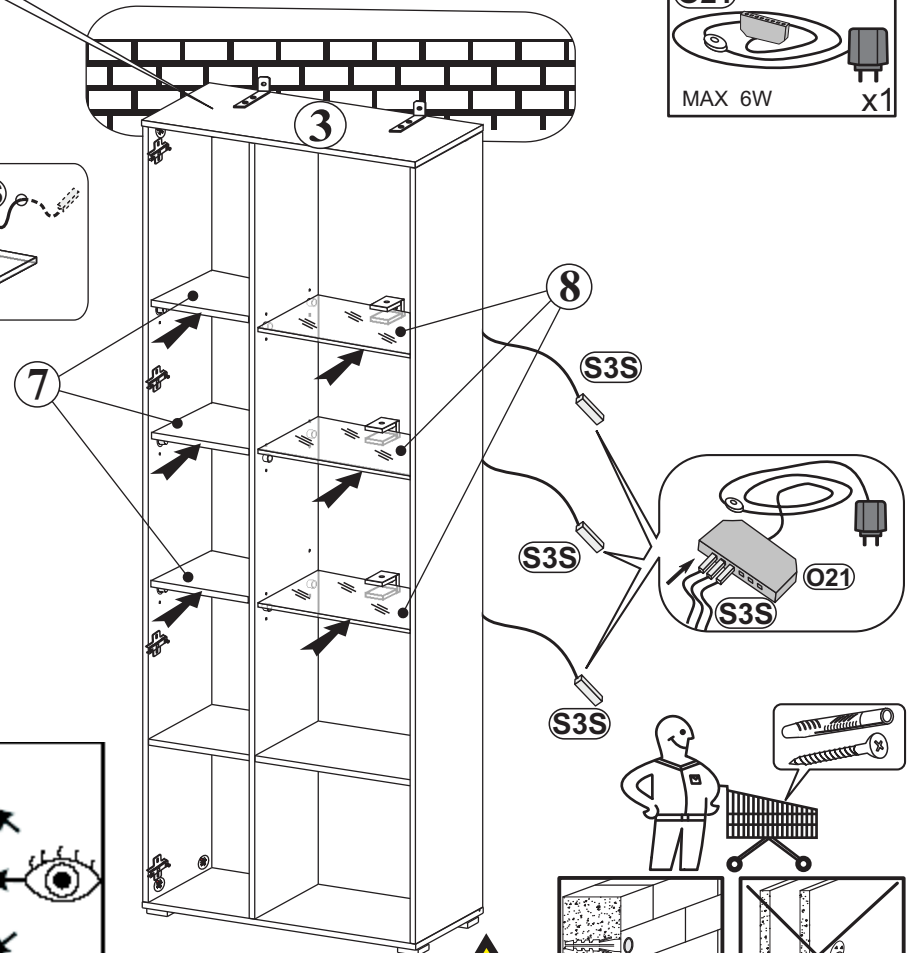
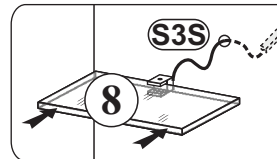
T14  6x50 mm x2

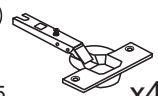

O21  MAX 6W x1



9

- Y0**  $\phi 35$ x4
- B20**  $\phi 8 \times 50$ x4
- M1**  $\phi 15 \times 12 \text{mm}$ x4
- S8**  4x13 x8
- Z5**  x1
- T1**  5x39mm x4

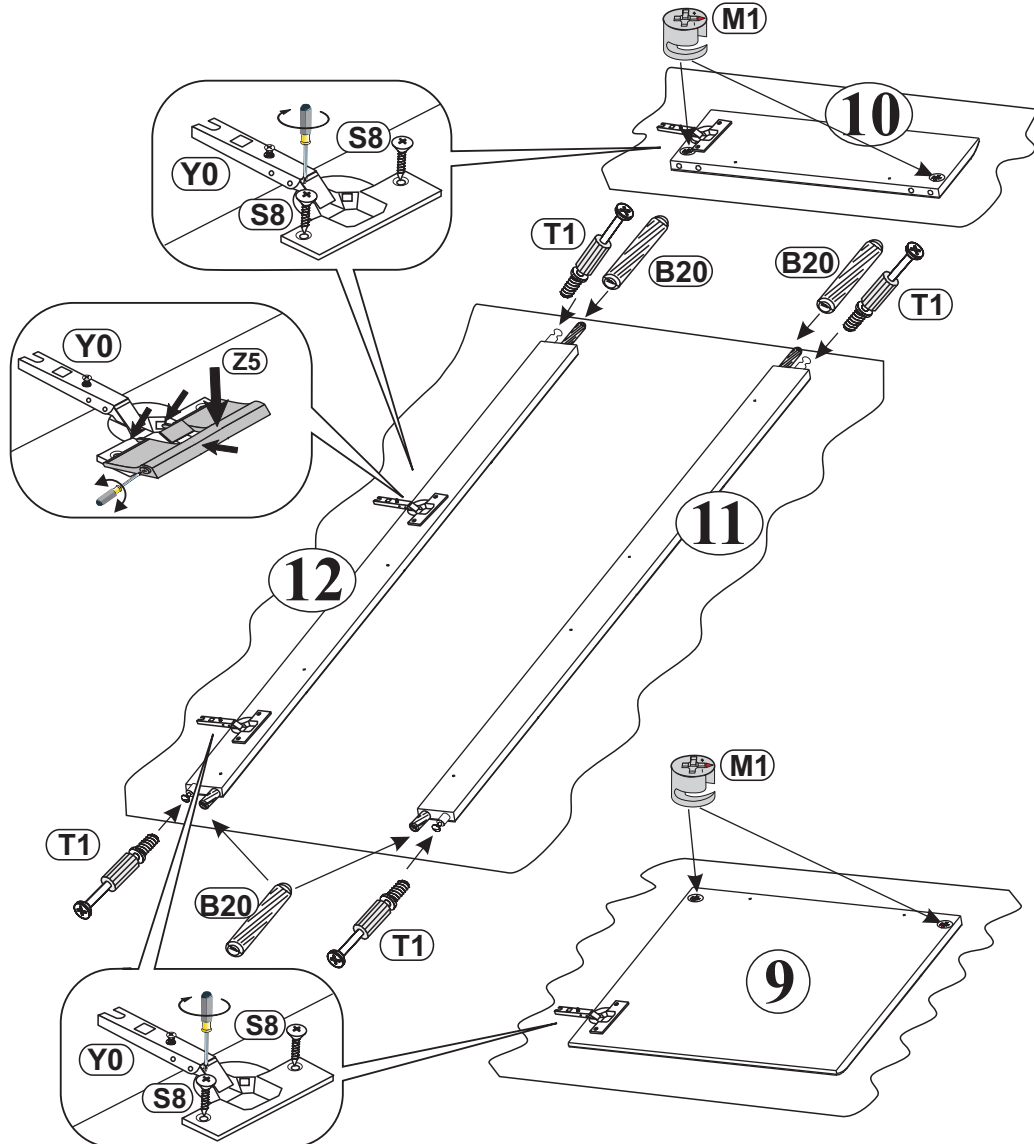

10

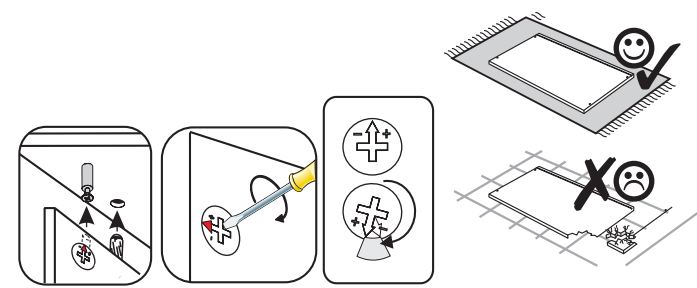
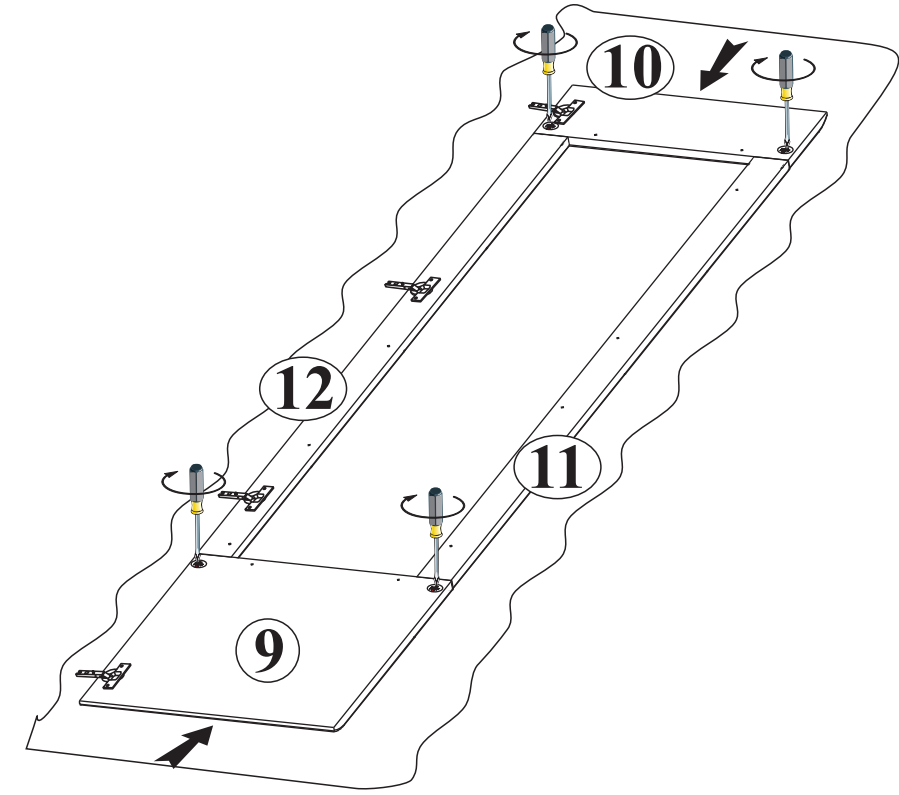

11

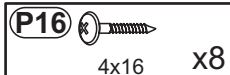
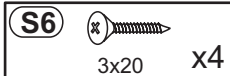
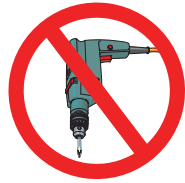

12

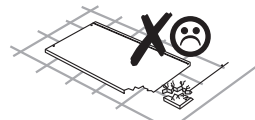
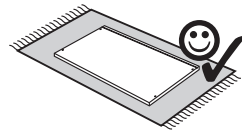
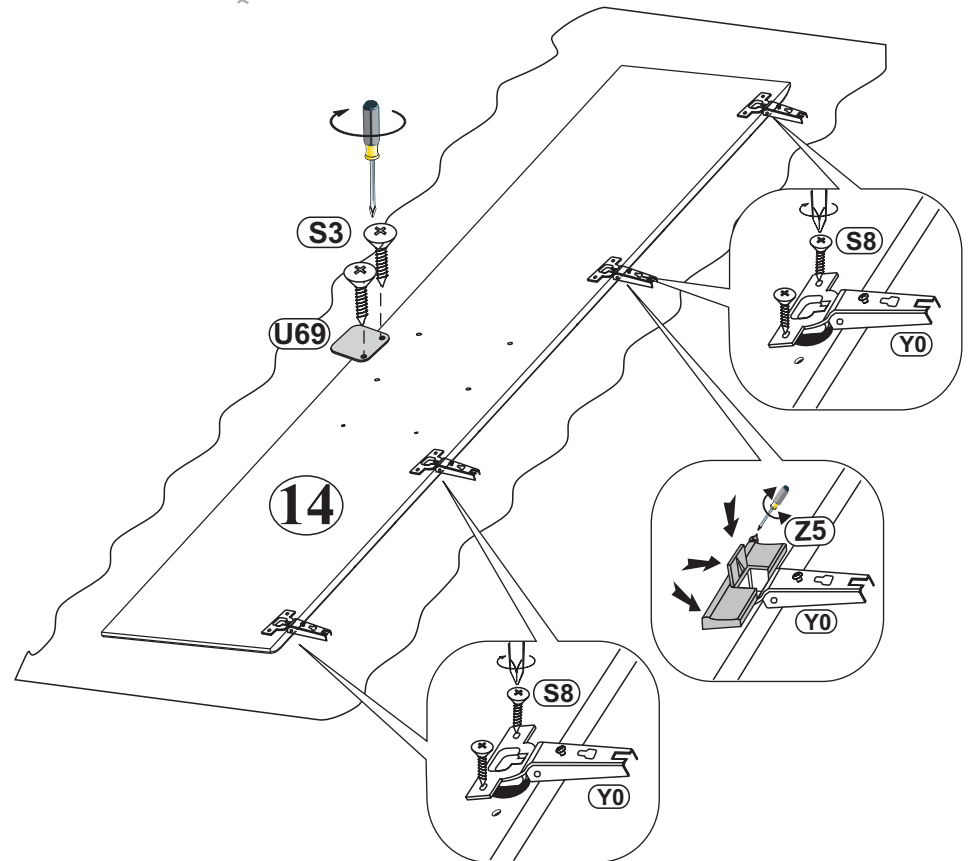
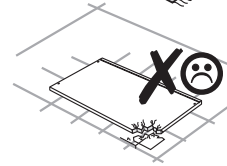
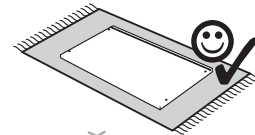
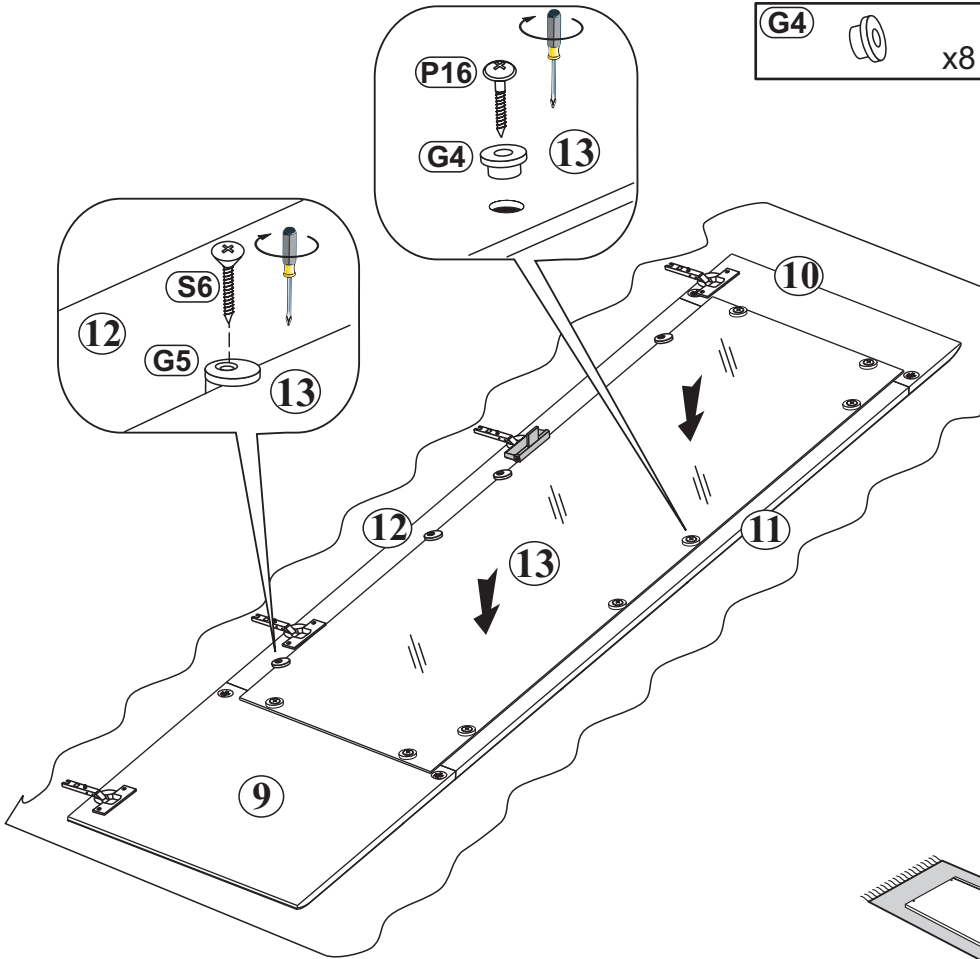
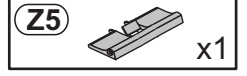
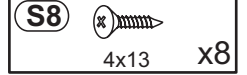
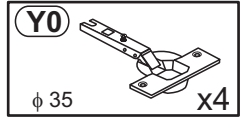
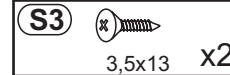
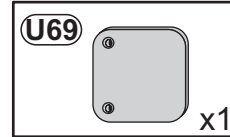

13

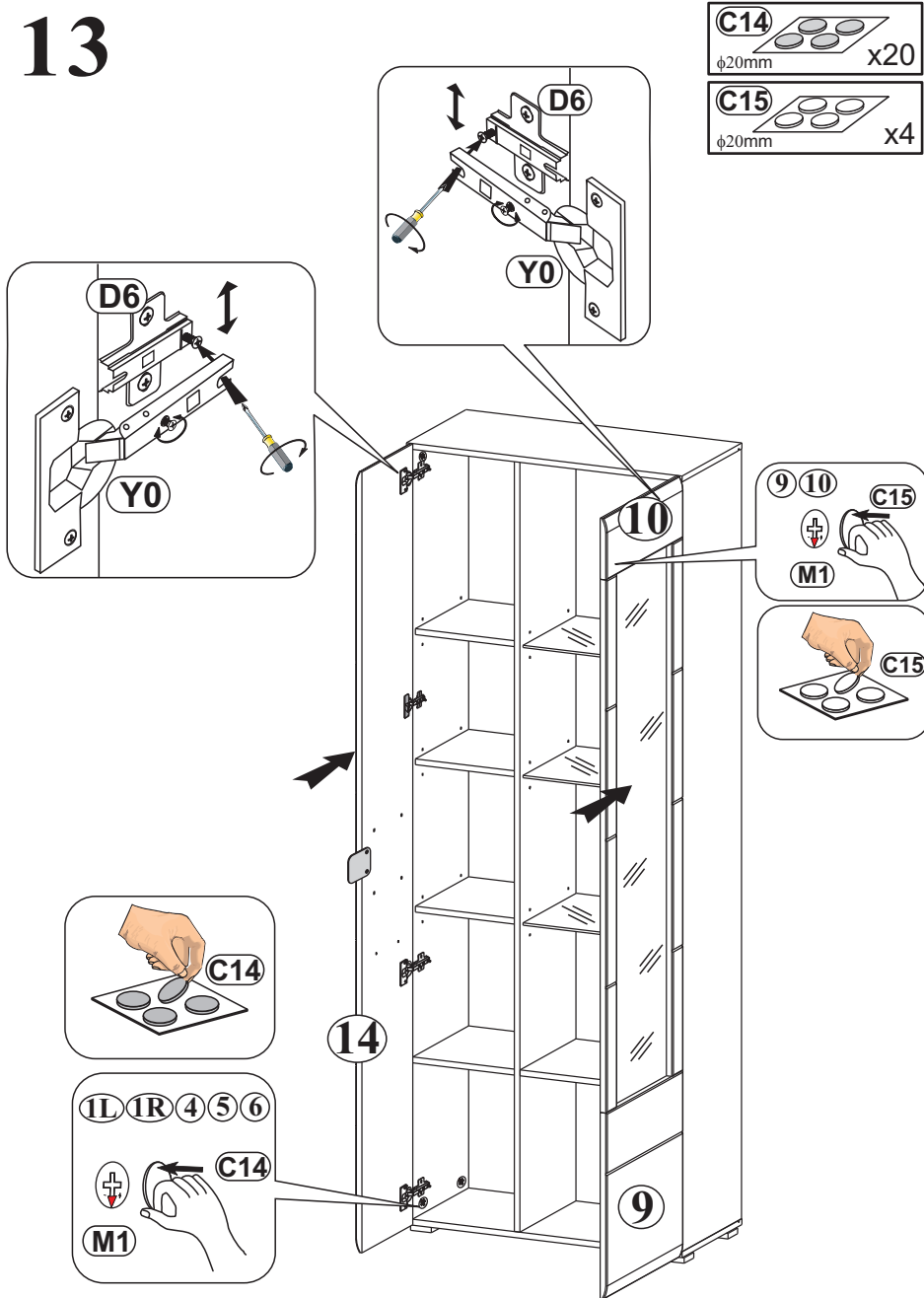

14

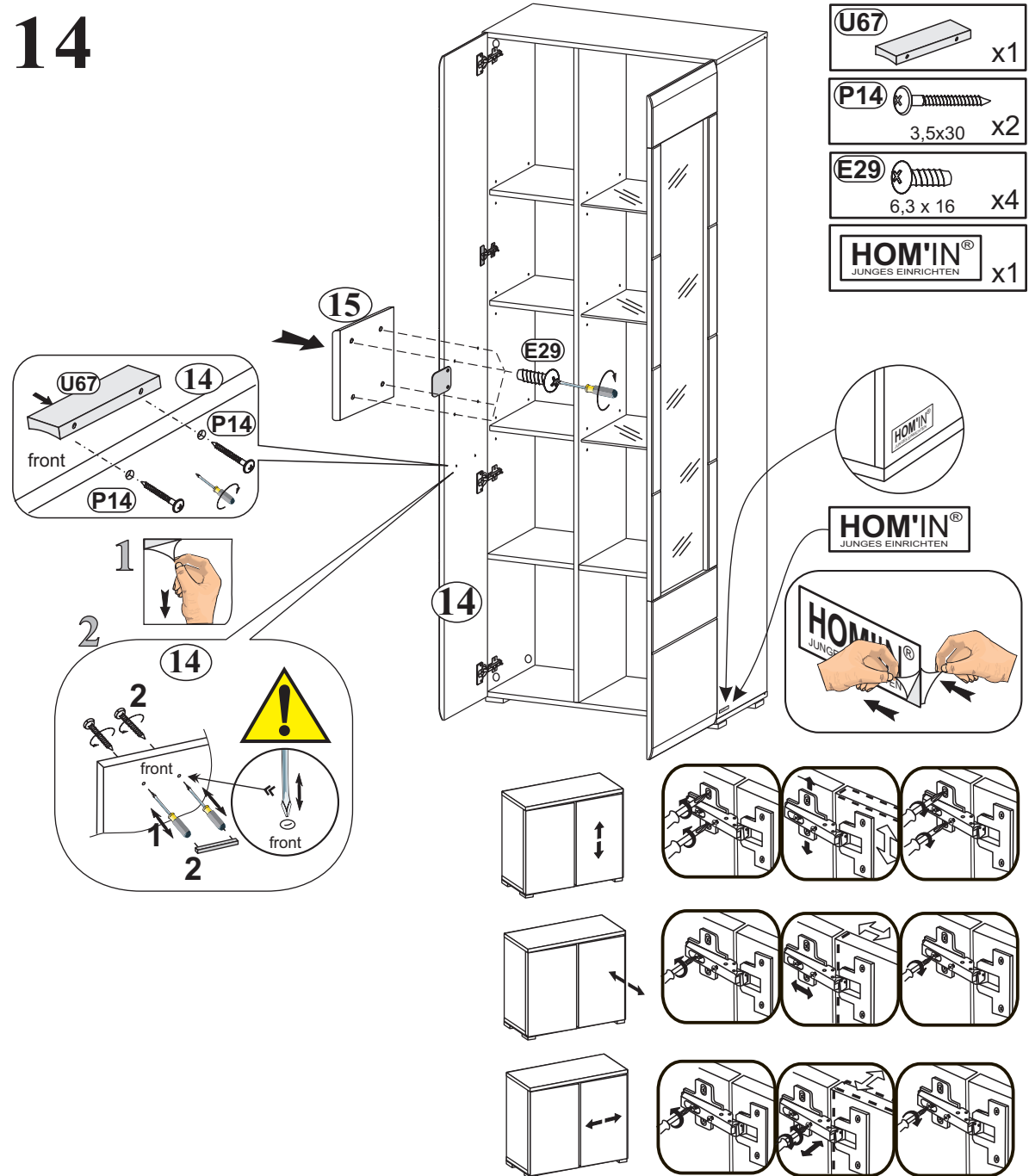

SAVONA

10E6--01

Type:01

12 / 12

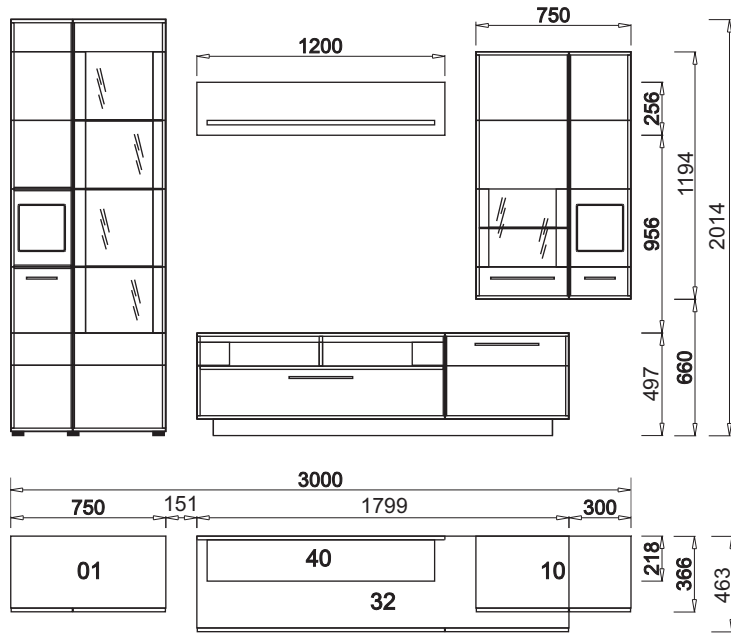

Kombination 81

D CH AT LI LU Kleinstele und Verpackungsfolien bei der Möbelmontage von Kindern fernhalten!
GB US Keep small parts and plastic film out of the reach of children!
FR BE NC Tenir les petites pièces et les films plastiques hors de la portée des enfants!
NL Hou de kleine onderdelen en de plastic folie uit de buurt van kinderen!
IT Tenere i componenti di piccole dimensioni e le pellicole di plastica fuori dalla portata dei bambini!
SI Malhni delov i foliju za pakovanje priklom montaži pohištna priane izven dosega otrok!
XS HR BA Mahe dijelove i foliju za pakovanje priklom montaže namještaja držite dalje od djece
HU Bútorészeket közbden a kis alkatrészek és a csomagoló fóliák gyerekekkel távol tartandók!
BG Дребни детайли и опаковъчни фолия да се държат далеч от деца при монтажа на мебелите!
CZ SK Vid montáži nábytku uchovávejte drobné díly a obalové fólie z dosahu dětí!
SE Vid möbelföringen ska smådelar och förpackningsfolien hållas oåtkomliga för barn!
RO Țineți departe de copil piesele mici și folia de ambalat la montarea mobiliei!
ES ¡Durante el montaje, mantenga alejados de los niños las piezas pequeñas y el material plástico de embalaje!

D CH AT LI LU Möbelmontage muss auf ebennem Untergrund erfolgen. Bei Wandmontagen immer geeignetes Befestigungsmaterial verwenden.
GB US Furniture must be assembled on a flat surface. For assembly to the wall only use suitable fixing materials.
FR BE NC Le meuble doit être monté sur une surface plane. Pour le montage mural, utilisez des accessoires de fixation adaptés au type de mur.
NL De meubels dienen op een vlakke ondergrond te worden gemonteerd. Voor wandmontage moeten geschikte bevestigingsmaterialen worden gebruikt.
IT Il montaggio dei mobili deve avvenire su un fondo piano. Per il montaggio si prega di utilizzare solo materiali adatti.
SI Pohištvo je treba montirati na ravni podlagi. Pri stenski montaži vedno uporabite pritrilveni material.
XS HR BA Namještaj se mora montirati na ravnoj podlozi. Kod montaže na zid uvijek koristite prikladan materijal za pričvršćivanje.
HU A bútorcszerelési silk felületen kell végezni. Falra szereléshez mindig megfelelő rögzítianyagot kell használni.
BG Монтажът на мебелите да се извършва на равна основа. При стенен монтаж винаги да се използва подходящ крепежен материал.
CZ SK Montáž nábytku provádějte na rovném podkladu. Při montáži na stěnu používejte vždy vhodný příslušovací materiál.
SE Monteringen av möbelen måste göras på jämnt underlag. Vid väggmontering ska lämpligt uppfästingsmaterial användas.
RO Montarea mobiliei trebuie să se realizeze pe o pardoseală dreaptă. La montarea la perete utilizați întotdeauna material de fixare adecvat.
ES El montaje debe efectuarse sobre una superficie uniforme. En el montaje mural emplee siempre el material de fijación adecuado.

D CH AT LI LU Bitte beachten Sie die Montageanleitung. Halten Sie immer die angegebene Wattzahl ein. Verhindern Sie einen Hitzestau.
GB US Please observe the assembly instructions. Do not exceed the max. given wattage. Ensure that the heat is not allowed to build up.
FR BE NC Veuillez respecter la notice de montage. Respectez impérativement le nombre des watts maximal. Veillez à éviter toute accumulation de chaleur.
NL Lees a.u.b. de montagehandleiding door. Hou de beslist aan het max. opgegeven wattage. Zorg ervoor dat geen hittehuwling onstaat.
IT Attenersi alle istruzioni di montaggio. Rispettarsi rigorosamente il numero di watt max. indicato. Assicurarsi che non si verifichi un accumolo di calore.
SI Upoštevajte navodila za montažo. Vedno upoštevajte navedeno število vatov. Preprečite zastoj vročine.
XS HR BA Obratite pažnju! Vas pozor na uputu za montažu. Uvijek se pridržavajte navedenog broja vai. Izbjegavajte zastoj vrućine.
HU Vegye figyelembe a szerelési útmutatót. Mindig tartsa be a megadott wattszámot. Akadályozza meg a hőelődést.
BG Моля, вземете под внимание ръководството за монтаж. Спазвайте винаги посочените ватове. Избягвайте акумулиране на топлина.
CZ SK Dodržujte prosím návod k montáži. Vždy dodržujte uvedenou hodnotu výkonu (watt). Zabráňte tak přehřívání.
SE Följ monteringsanvisningen. Följ alltid angivet watttal. Undvik att hetta uppstår.
RO Respectați instrucțiunile de montaj. Respectați întotdeauna numărul de watt impus. Evitați acumularea de căldură.
ES Le rogamos que tenga presente las instrucciones de montaje. Respete siempre el número indicado de vatios. Evite la acumulación de calor.

D CH AT LI LU Halten Sie die max. zulässigen Belastungswerte der Möbelteile ein. Details siehe Montageanleitung
GB US Comply with the max. permissible loads. For details, please refer to the assembly instructions
FR BE NC Respectez les valeurs de charge max. admissibles des parties de meubles. Pour plus de détails, cf. la notice de
NL Hou de maximaal geoorloofde belastingswaarden van de meubeldelen aan. Voor details verwijzen wij naar de montagehandleiding
IT Rispettare la portata max. permessa degli elementi del mobile. Per dettagli si vedano le istruzioni di montaggio e si vada
SI Upoštevajte največjo dovoljeno obremenitev delov pohištna. Podrobnosti najdete v navodilih za montažo in na
XS HR BA Tartsa be a bútorelemek max. megengedett terhelési értékét. A részleteket lásd a szerelési útmutatóban
HU Tartsa végre a bútorelemek max. megengedett terhelési értékét. A részleteket lásd a szerelési útmutatóban
BG Спазвайте макс. допустимите стойности на натоварване на мебелите. За подробности виж ръководството за монтаж
CZ SK Dodržujte max. přípustné hodnoty zatížení nábykových dílů. Podrobnosti viz návod k montáži
SE Följ max. tillåten belastning av möbeldelarna. Mer information finns i monteringsanvisningen
RO Respectați valorile de solicitare max. admise pentru corpurile de mobilier. Pentru detalii consultați instrucțiunile de montaj
ES Respete los valores máximos de carga admisibles para las piezas de los muebles. Consulte los detalles en las instrucciones

D CH AT LI LU Zur Möbelföringung ein mit Wasser befeuchtetes, fusselfreies Baumwolltuch verwenden. Geeignigte Flächen immer trockenreiben!
GB US To clean the furniture only use a water dampened lint-free cotton cloth. Once cleaned, always wipe the surfaces dry.
FR BE NC Utilisez un chiffon en coton non pelucheux humidifié avec de l'eau pour nettoyer les meubles. Séchez systématiquement les surfaces
NL nettooyes en les frottant!
IT Gebuik een met water bevochtigde, pluusvrije katoenen doek om de meubels te reinigen. Wrijf gereinigde oppervlakken altijd droog!
SI Per pulire il mobile utilizzare un panno di cotone inumidito d'acqua e che non perde pelucchi. Asciugare sempre le superfici che si sono
XS HR BA krpomi!
HU Za čišćenje pohištva uporabljajte vlažno bombažno krpo, ki ne pušča vlaken. Očišćene površine vedno obrišite do suhnega!
BG За čišćenje namještaja koristite sa vodom navlaženu pamučnu krpu koja ne ispušta vlakna. Očišćene površine uvijek obrišite suhom
CZ SK K čištění nábytku používejte bavlněný hadr neuvloňující vlákna, navlhčený ve vodě. Učištěné plochy vždy utřete do sucha!
SE För möbelföring används en luddfri bomullsduk fuktad med vatten. Rengörda ytor ska alltid torkas torra!
RO Pentru curățarea mobiliei utilizați o lavetă din bumbac fără scame umezită cu apă. Suprafețele curățate se șterg întotdeauna până se usucă!
ES Emplee un paño de algodón humedecido con agua y libre de pelusa para la limpieza de los muebles. ¡Seque siempre las superficies que ha limpiado!