

SAVONA

10E6--21

Type:21

1 / 14

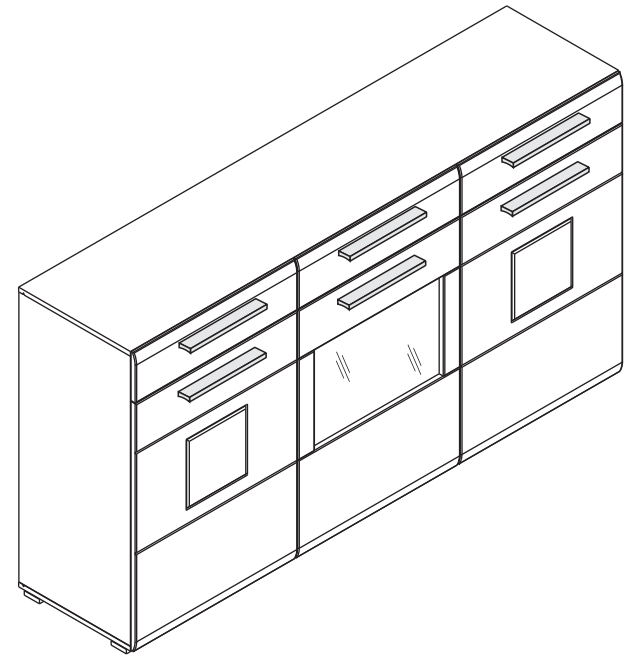
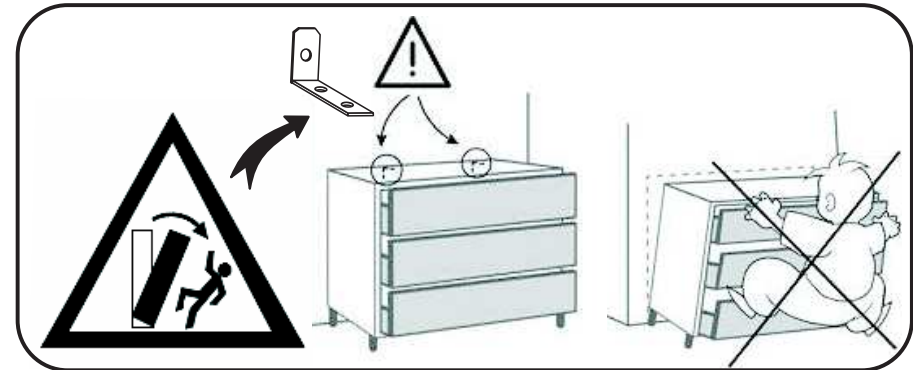
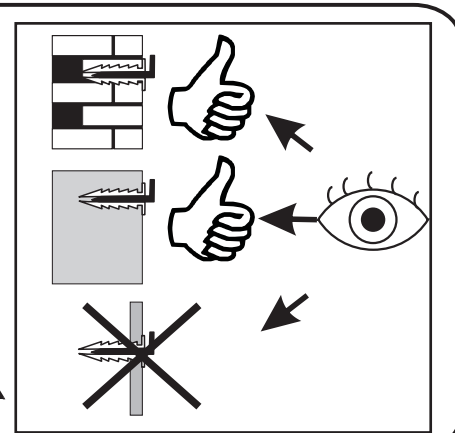
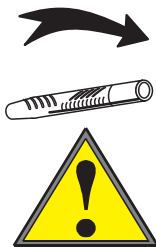
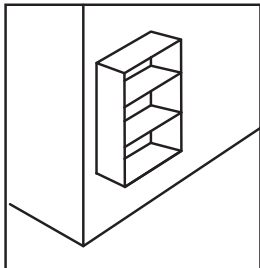
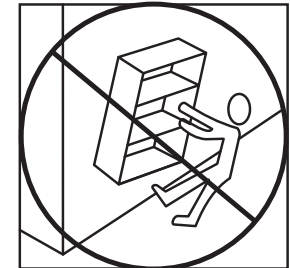
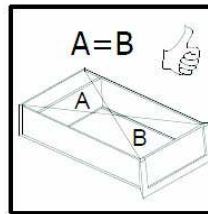
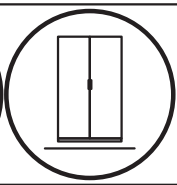
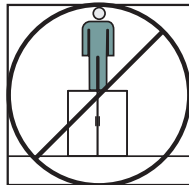
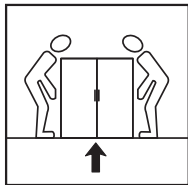
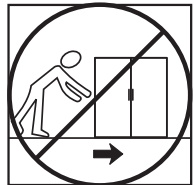
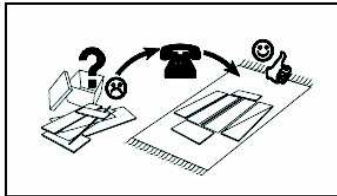
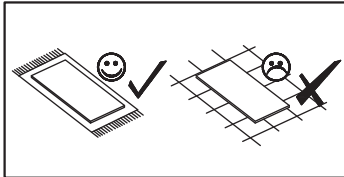
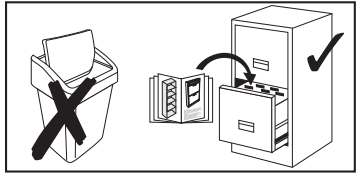
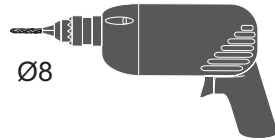
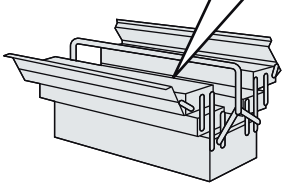
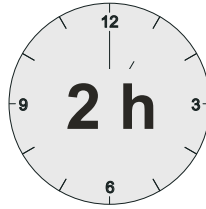
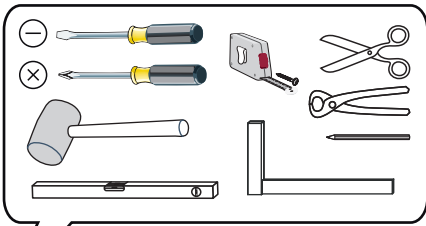
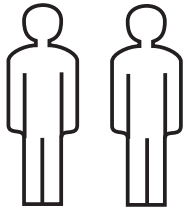

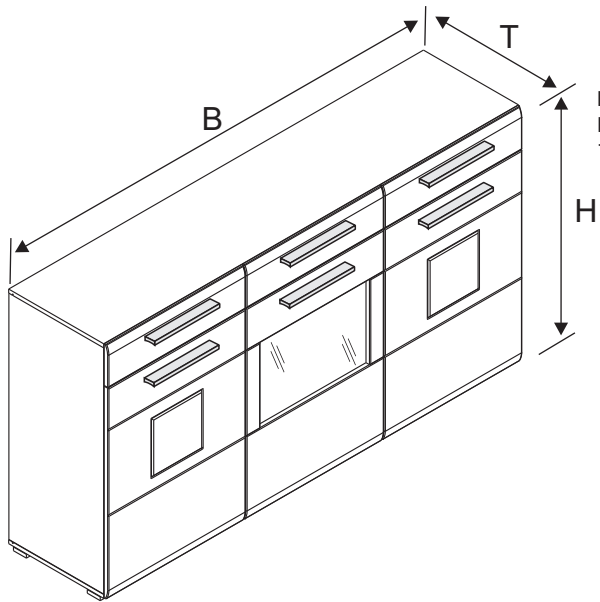

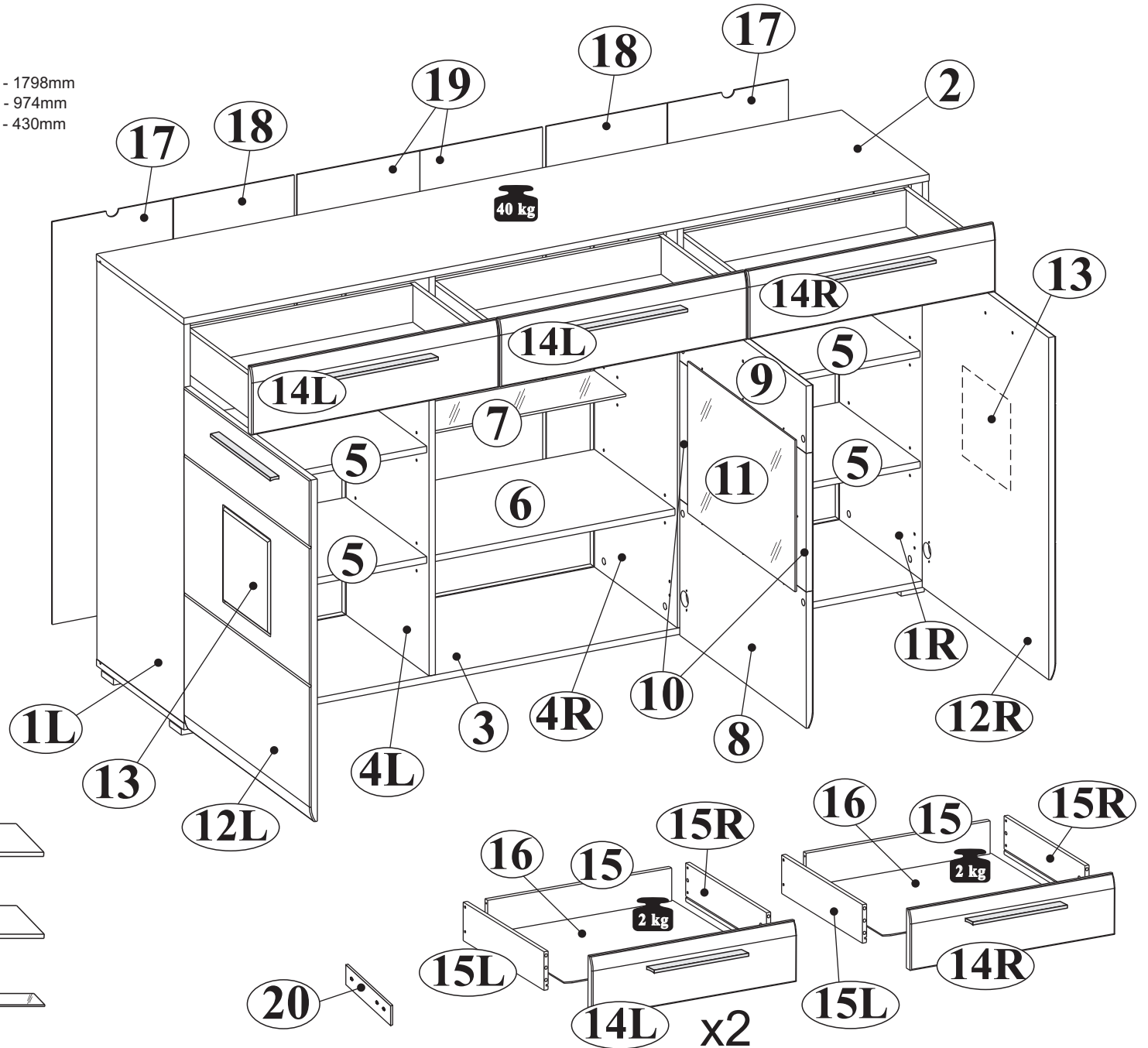

B - 1798mm  
H - 974mm  
T - 430mm



1L,1R	924	411	2	1/3
2	1798	412	1	3/3
3	1798	412	1	3/3
4L,4R	924	411	2	1/3
5	576	380	4	3/3
6	584	380	1	2/3
7	582	150	1	2/3
8	596	316	1	2/3
9	596	156	1	2/3
10	321	60	2	2/3
11	506	351	1	2/3
12L,12R	793	596	2	2/3
13	218	218	2	2/3
14L	596	156	2	2/3
14R	596	156	1	2/3
15	536	100	3	2/3
15L	352	100	3	2/3
15R	352	100	3	2/3
16	547	350	3	2/3
17	933	291	2	1/3
18	933	291	2	1/3
19	933	592	1	1/3
20	250	60	1	2/3

**NR 1**

**(B1)**   $\phi$  8x28 x16

**(B20)**   $\phi$  8x50 x4

**(M1)**  x20  
 $\phi$ 15x12mm

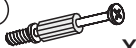
**(T1)**  x20  
5x39mm

**(W1)**  x20

**(W13)**  x4

**HOM'IN®**  
JUNGES EINRICHTEN x1

**NR 2**

**(J23)**  x26

**(G5)**  x8

**(S6)**  x8  
3x20

**(E29)**  x8  
6,3 x 16

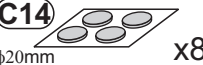
**(C14)**  x8  
 $\phi$ 20mm

**(C15)**  x4  
 $\phi$ 20mm

**NR 3**

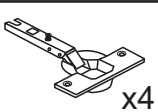
**(Y0)**  x4  
 $\phi$  35

**(D6)**  x4  
H2

**(E3)**  x8  
6,3x13

**(S8)**  x8  
4x13

**(Z5)**  x2

**NR 4**

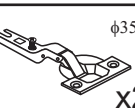
**(Y2)**  x2  
 $\phi$ 35  
Kr8

**(D6)**  x2  
H-2

**(E3)**  x4  
6,3x13

**(S8)**  x4  
4x13

**(Z5)**  x1

**NR 5**

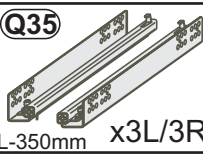
**(Q35)**  x3L/3R  
L-350mm

**(E24)**  x6  
6,0x11

**(E2)**  x9  
6x8

**(E26)**  x3  
6x16mm

**(P5)**  x12  
4x30

**(M2)**  x6  
12x10mm

**(T2)**  x6  
5x35mm

**NR 6**

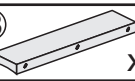
**(U68)**  x6

**(P14)**  x18  
3,5x30

**NR 7**

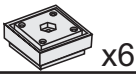
**(N20)**  x6

**(S2)**  x12  
4x30

**NR 8**

**(J11)**  x2

**(P13)**  x4  
3,5x13

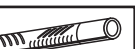
**(T13)**  x2  
8x50 mm

**(T14)**  x2  
6x50 mm

**NR 9**

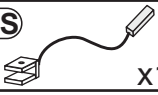
**(S3S)**  x1

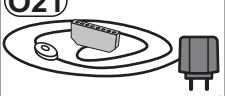
**(O21)**  x1  
MAX 6W

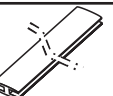
**(L2)**  x2  
L=922 mm

<http://www.innostyle-mvg.de>

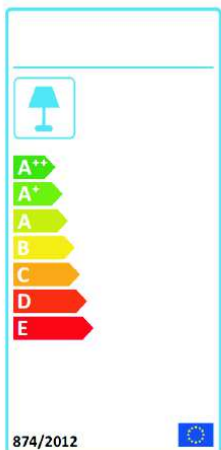

BG	Bulgarisch	български
CS	Tschechisch	čeština
DA	Dänisch	Dansk
DE	Deutsch	Deutsch
ET	Estnisch	Eesti
EL	Griechisch	ελληνικά
EN	Englisch	English
ES	Spanisch	español
FR	Französisch	Français
FI	Finnisch	suomalainen
HR	Kroatisch	hrvatski
HU	Ungarisch	magyar
IT	Italienisch	Italiano
LV	Lettisch	Latvijas
LT	Litauisch	Lietuvos
NL	Niederländisch	Nederlands
PL	Polnisch	Polski
PT	Portugiesisch	português
RO	Rumänisch	român
SK	Slowakisch	slovenský
SL	Slowenisch	slovensščina
SV	Schwedisch	Svenska



# 1

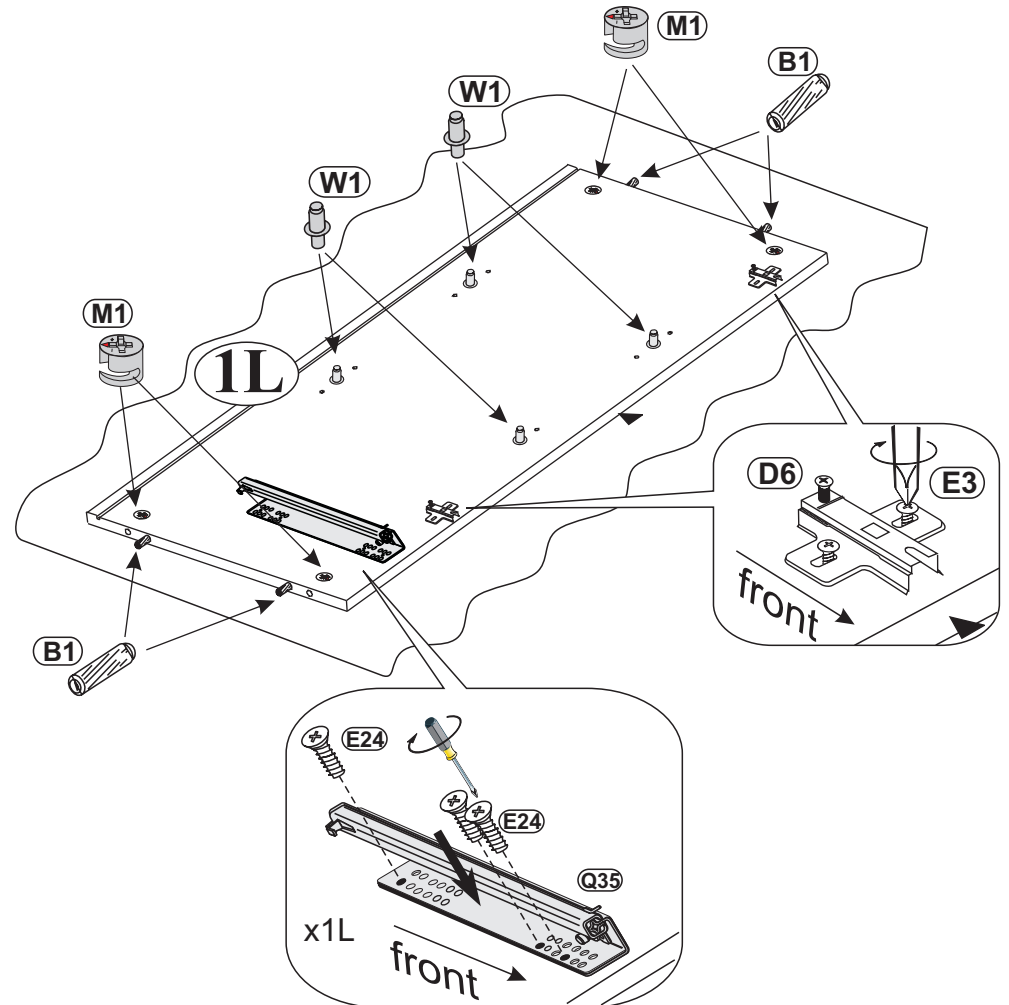
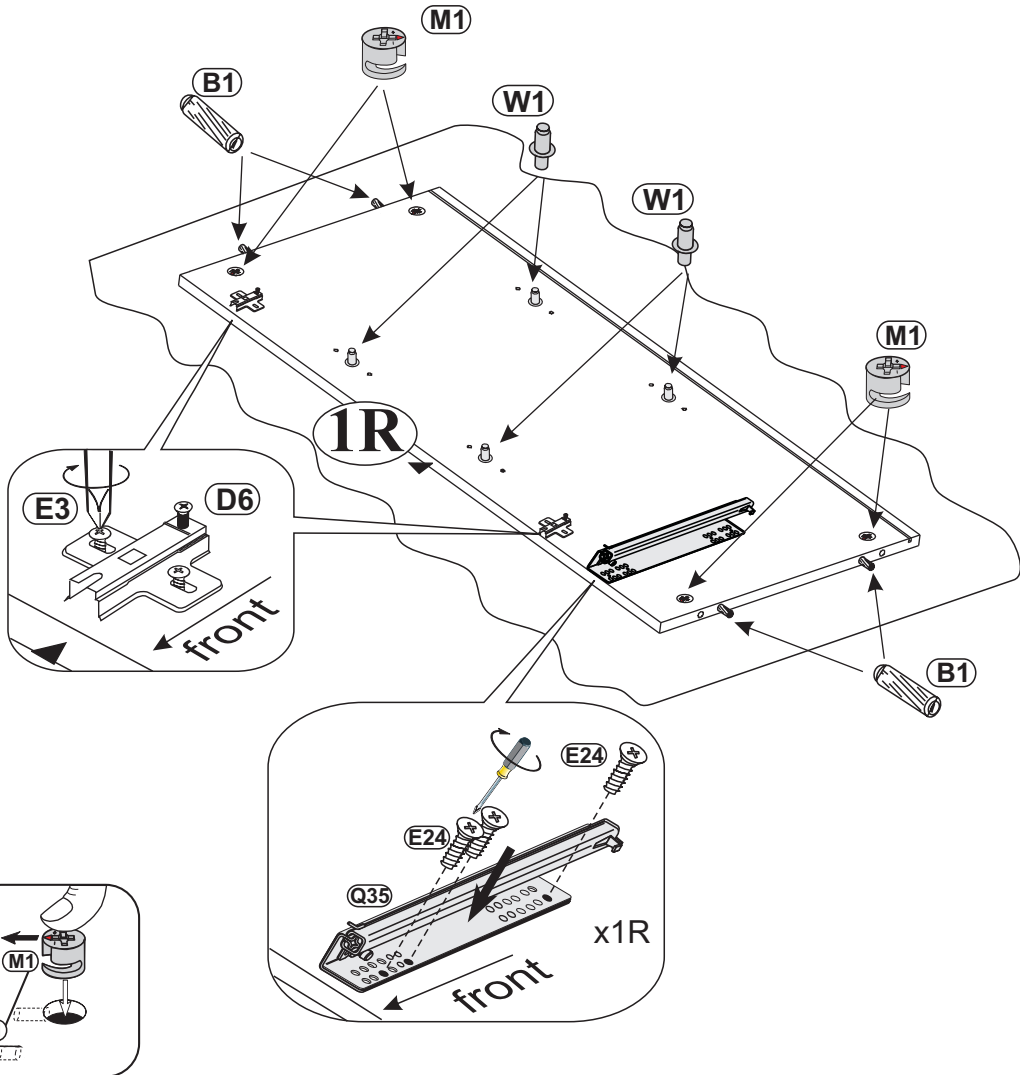
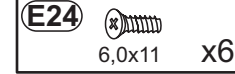
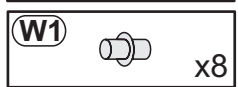
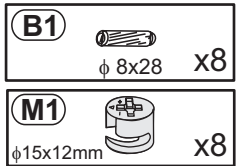
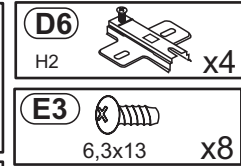
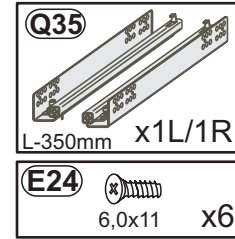
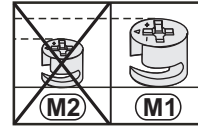
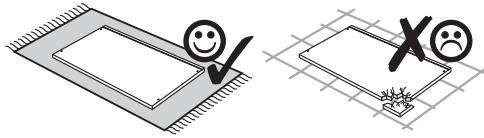

2

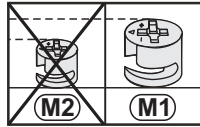
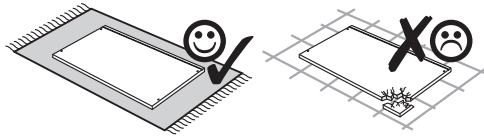

- E2** 6x8 x3
- E26** 6x16mm x3
- Q35** L-350mm x1L/1R
- B1**  $\phi$  8x28 x4
- M1**  $\phi$ 15x12mm x4
- W1** x6
- W13** x2

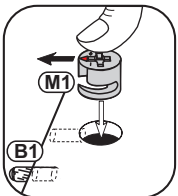
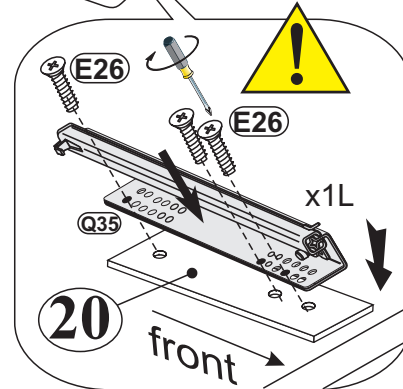
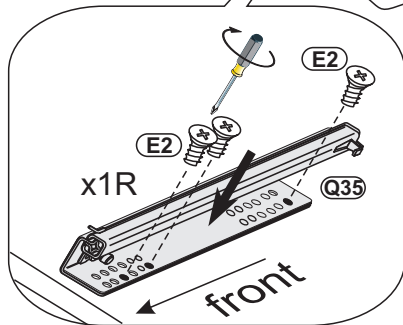
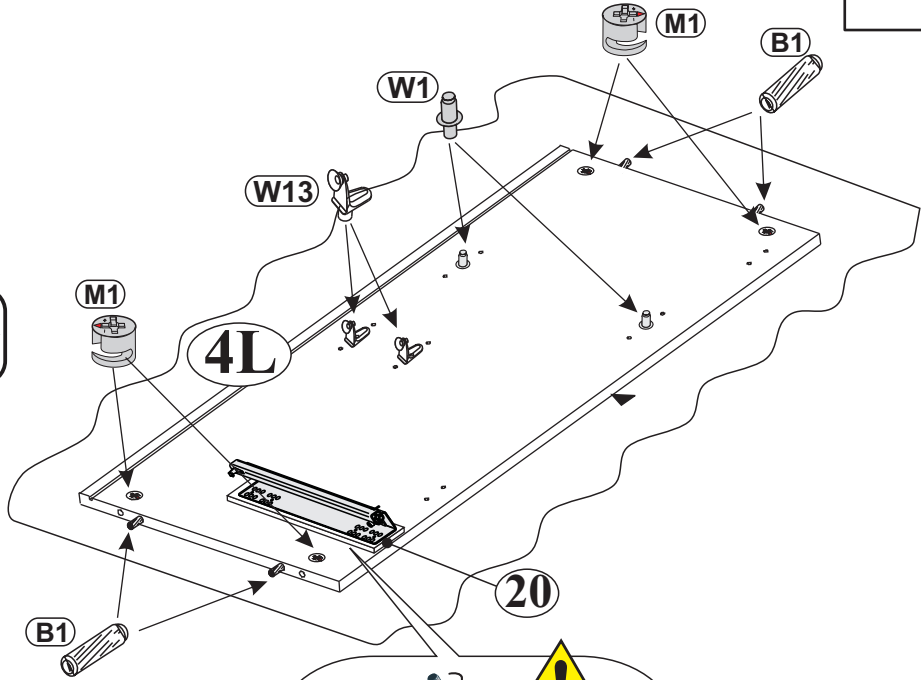
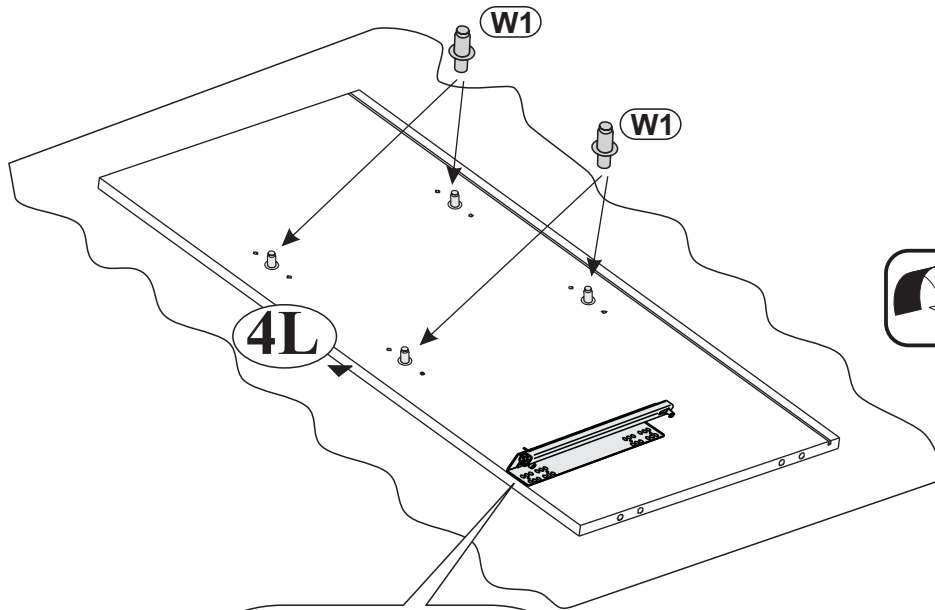



3

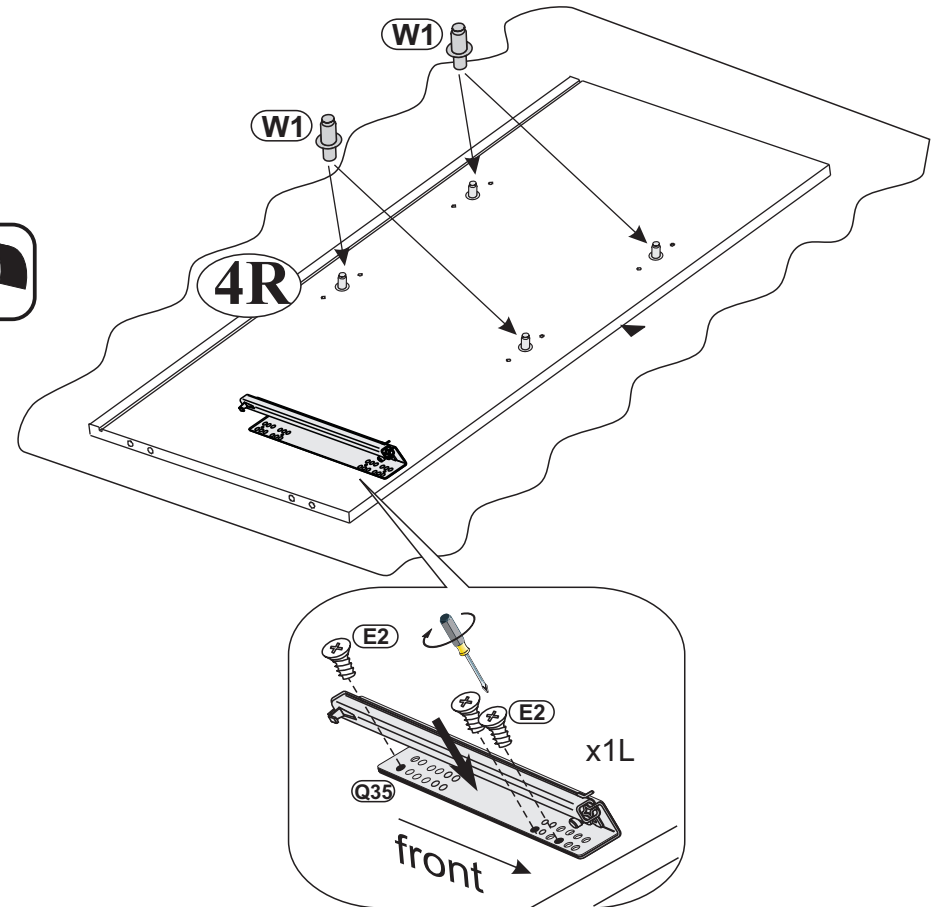
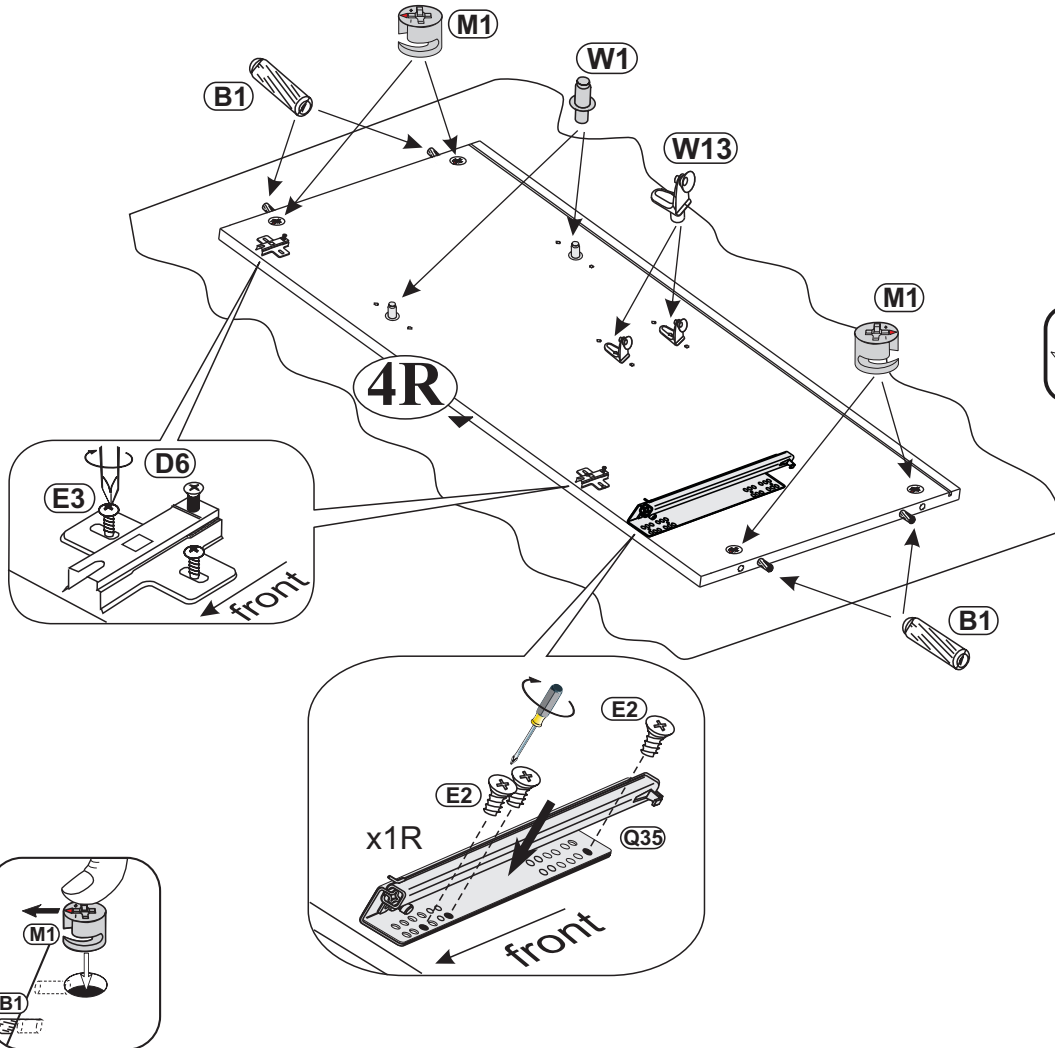
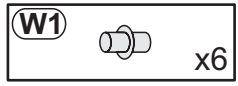
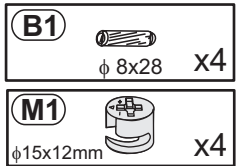
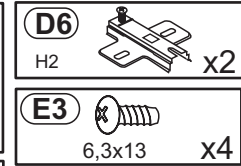
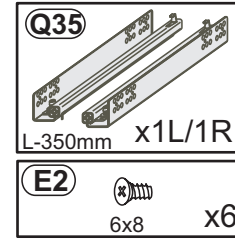
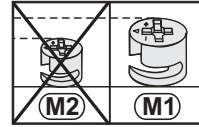
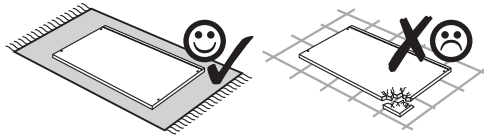

4

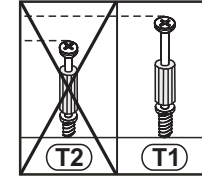
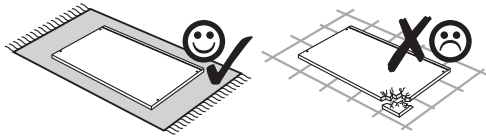

- T1** 5x39mm x16
- N20** x6
- S2** 4x30 x12

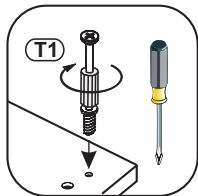
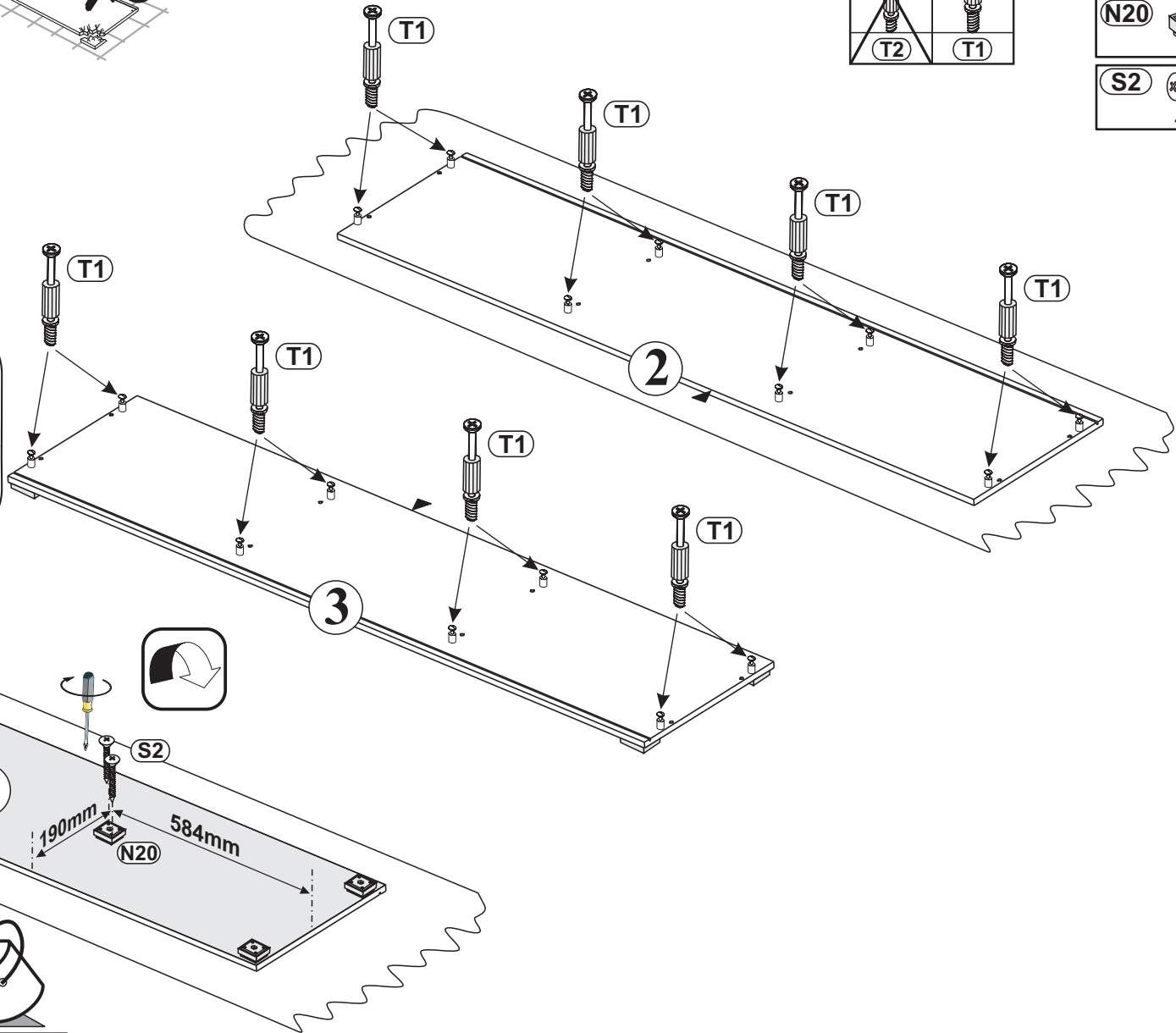
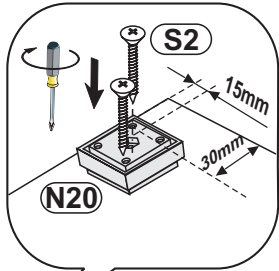
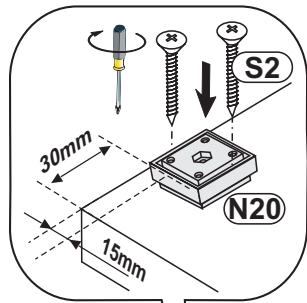

5

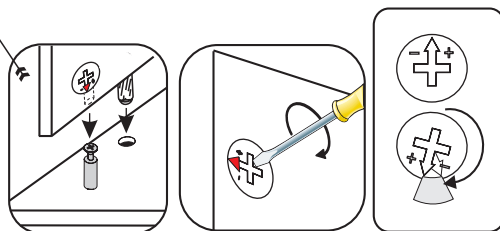
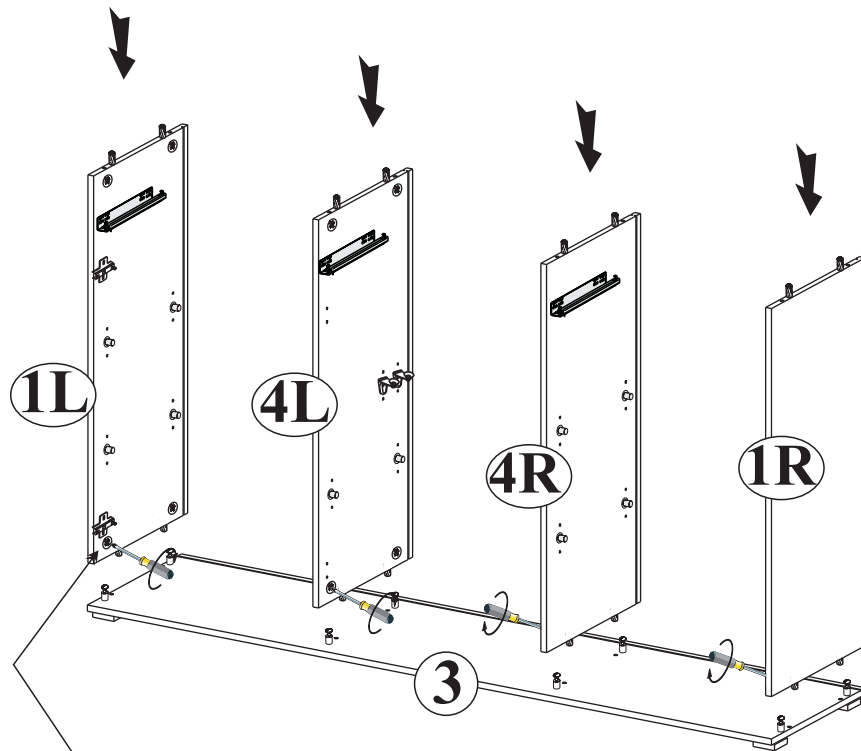

6

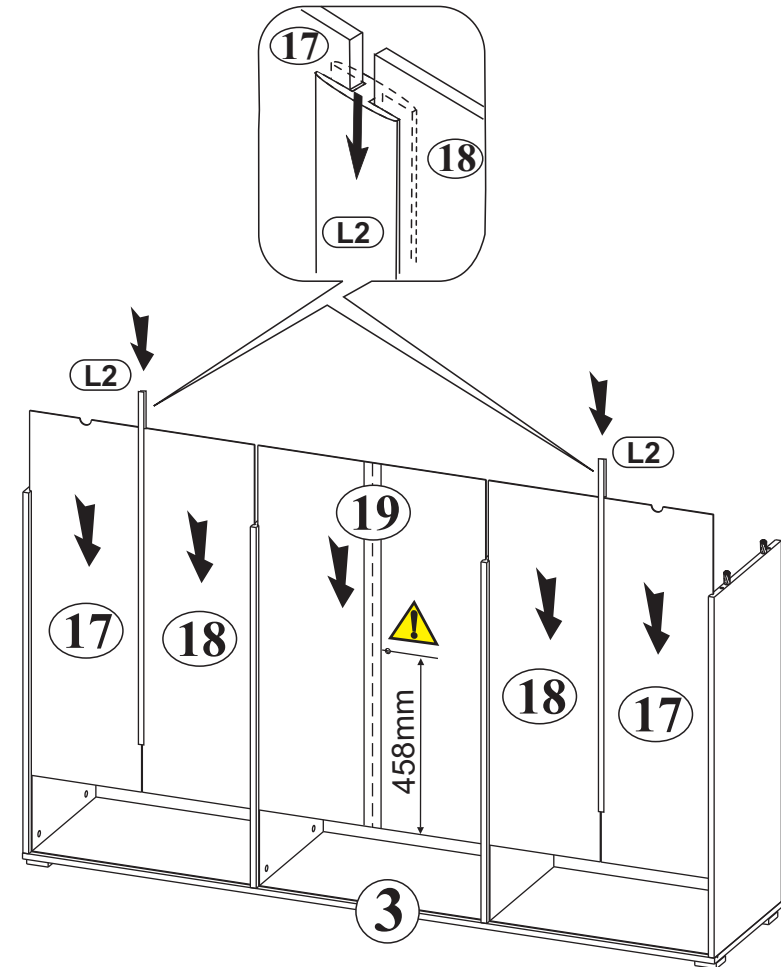
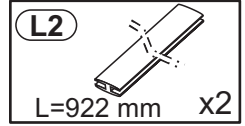



7

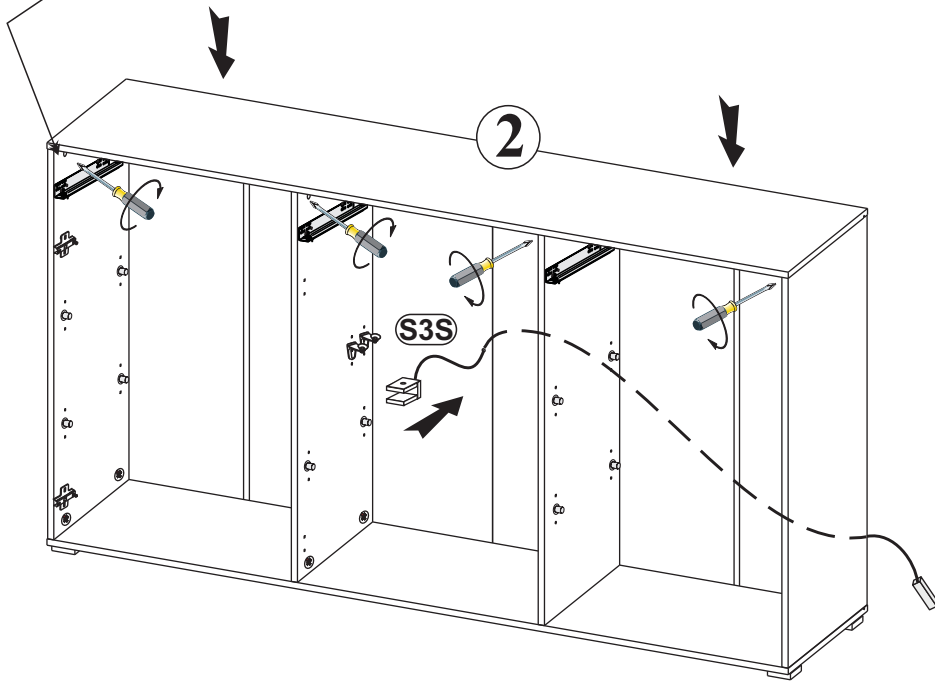
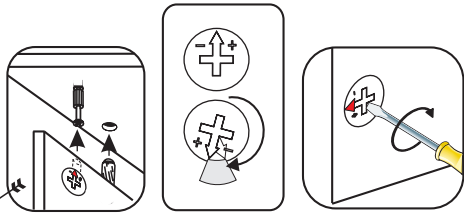
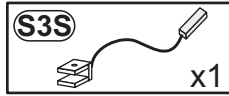

8

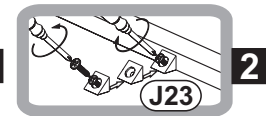
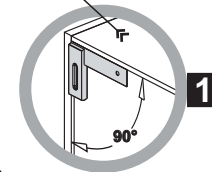
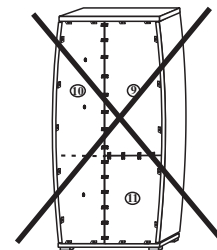
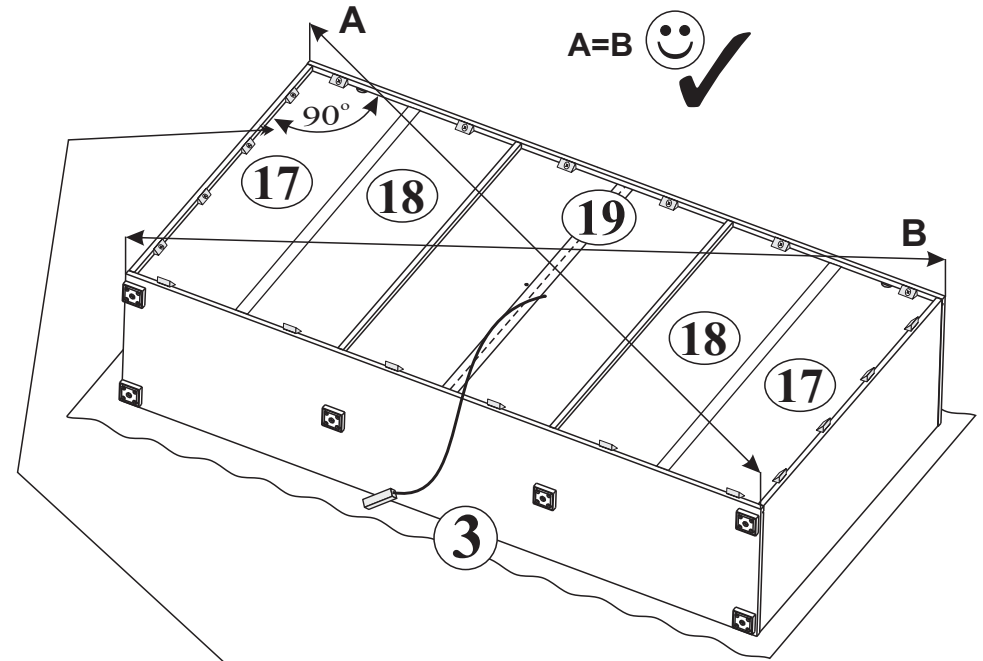
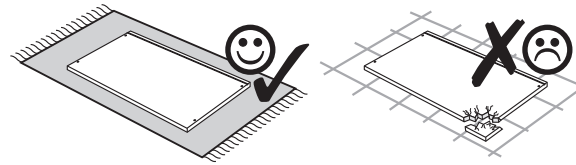

# SAVONA

# 10E6--21

# Type:21

10 / 14

- 9**
- J11** x2
  - P13** 3,5x13 x4
  - T13** 8x50 mm x2
  - T14** 6x50 mm x2

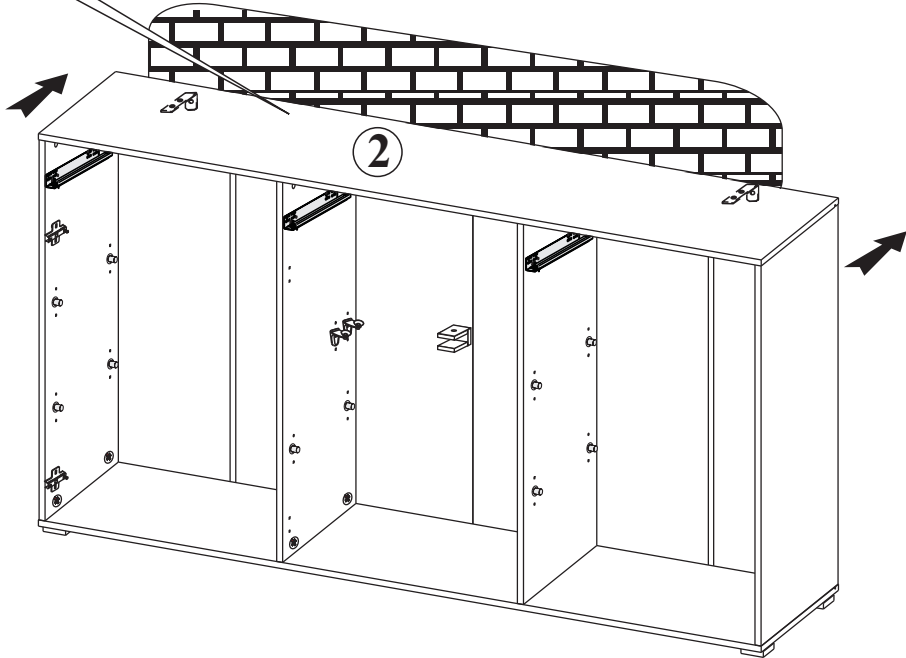
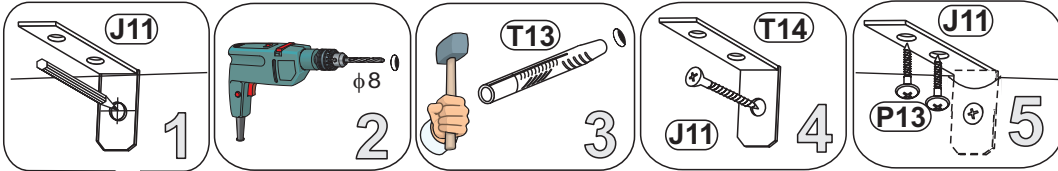

# 10

- Z5** x1
- B20**  $\phi 8 \times 50$  x4
- T1** 5x39mm x4
- Y2**  $\phi 35$  x2
- S8** 4x13 x4
- M1**  $\phi 15 \times 12 \text{mm}$  x4

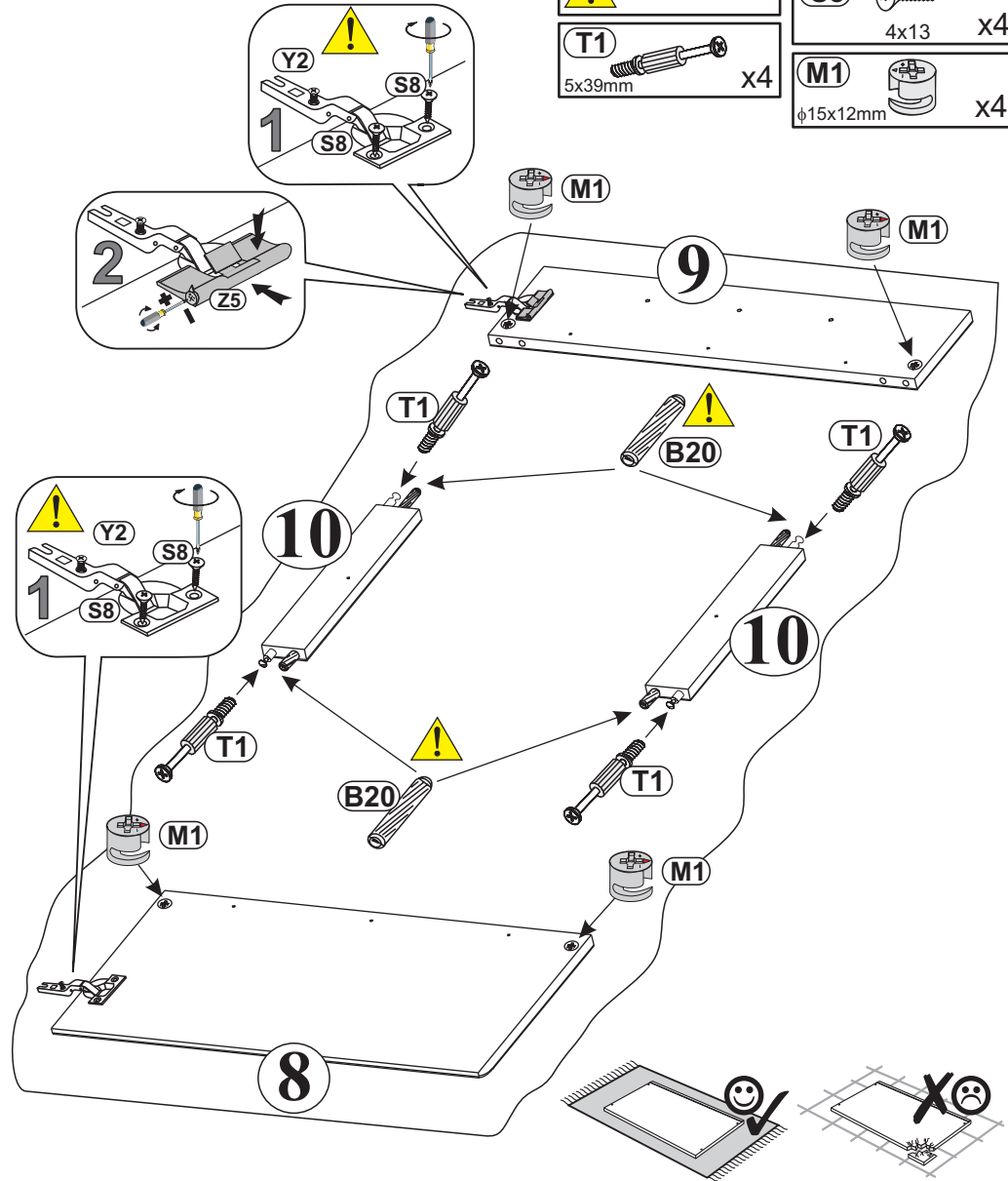

11

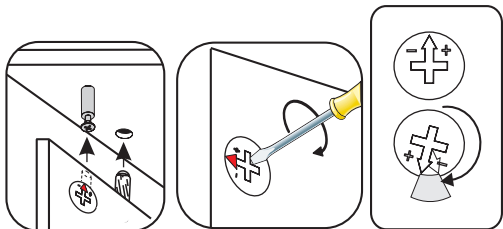
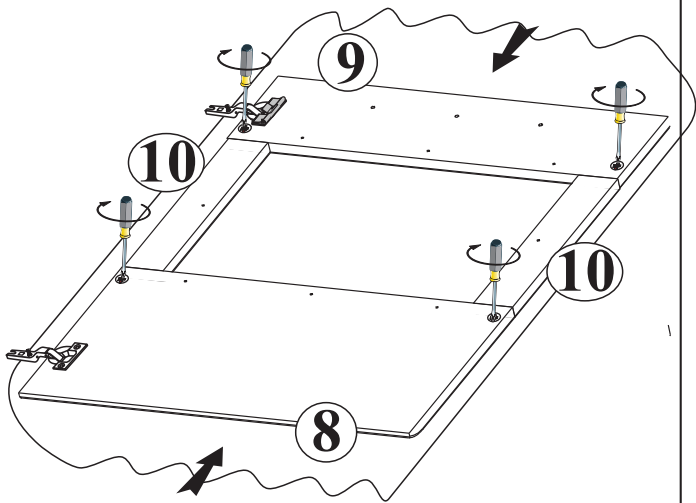

12

- G5 x8
- S6 3x20 x8

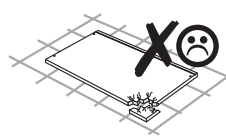
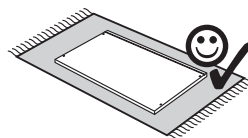
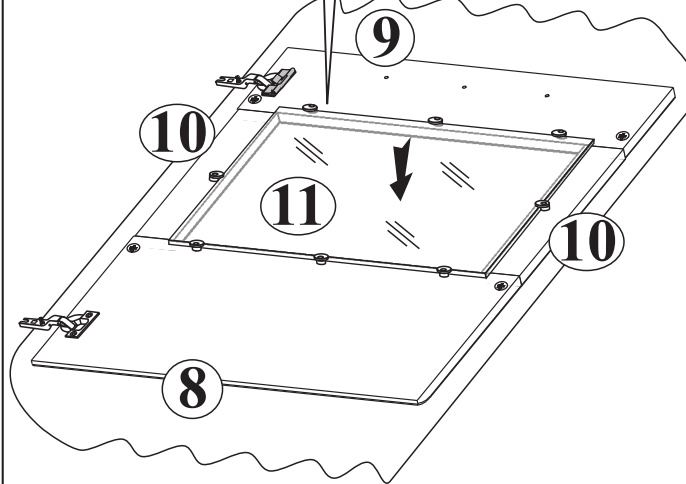
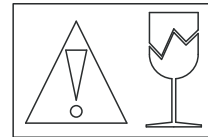
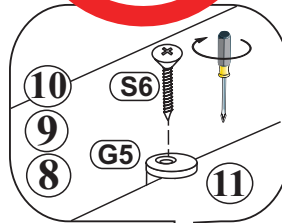
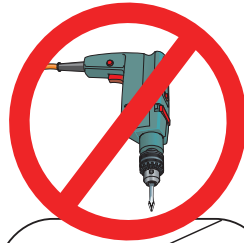

13

- Y0 x4  
φ 35
- S8 4x13 x8
- Z5 x2

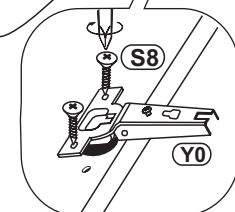
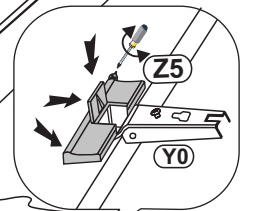
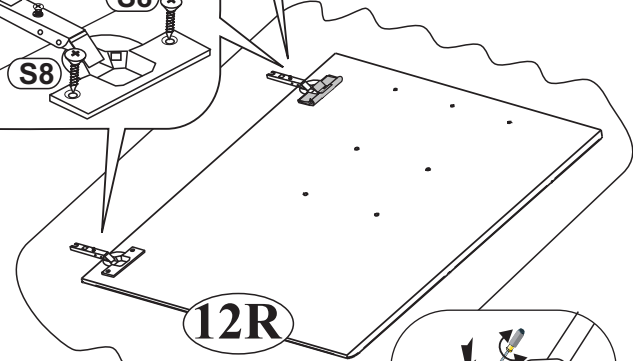
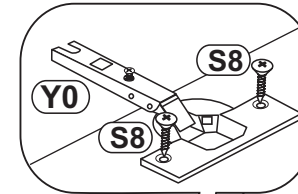
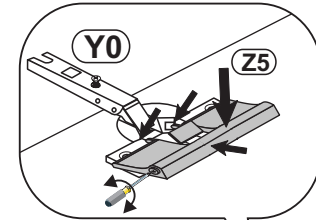

## 14

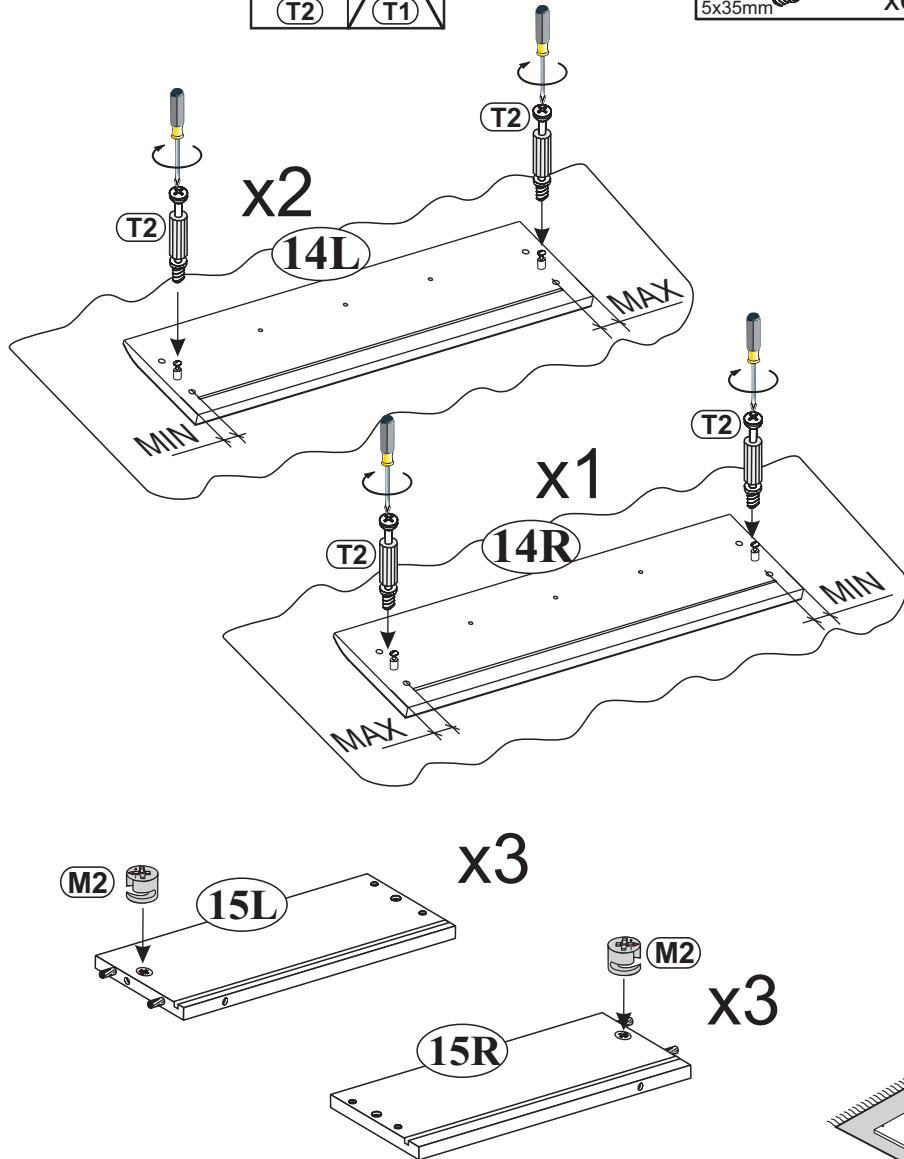
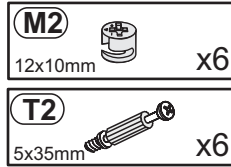
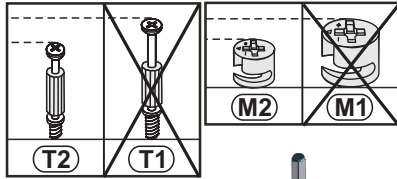

## 15

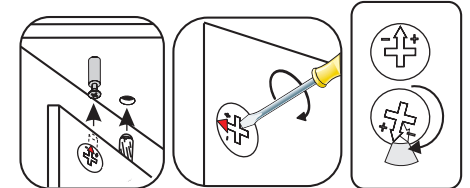
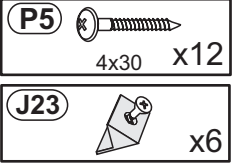
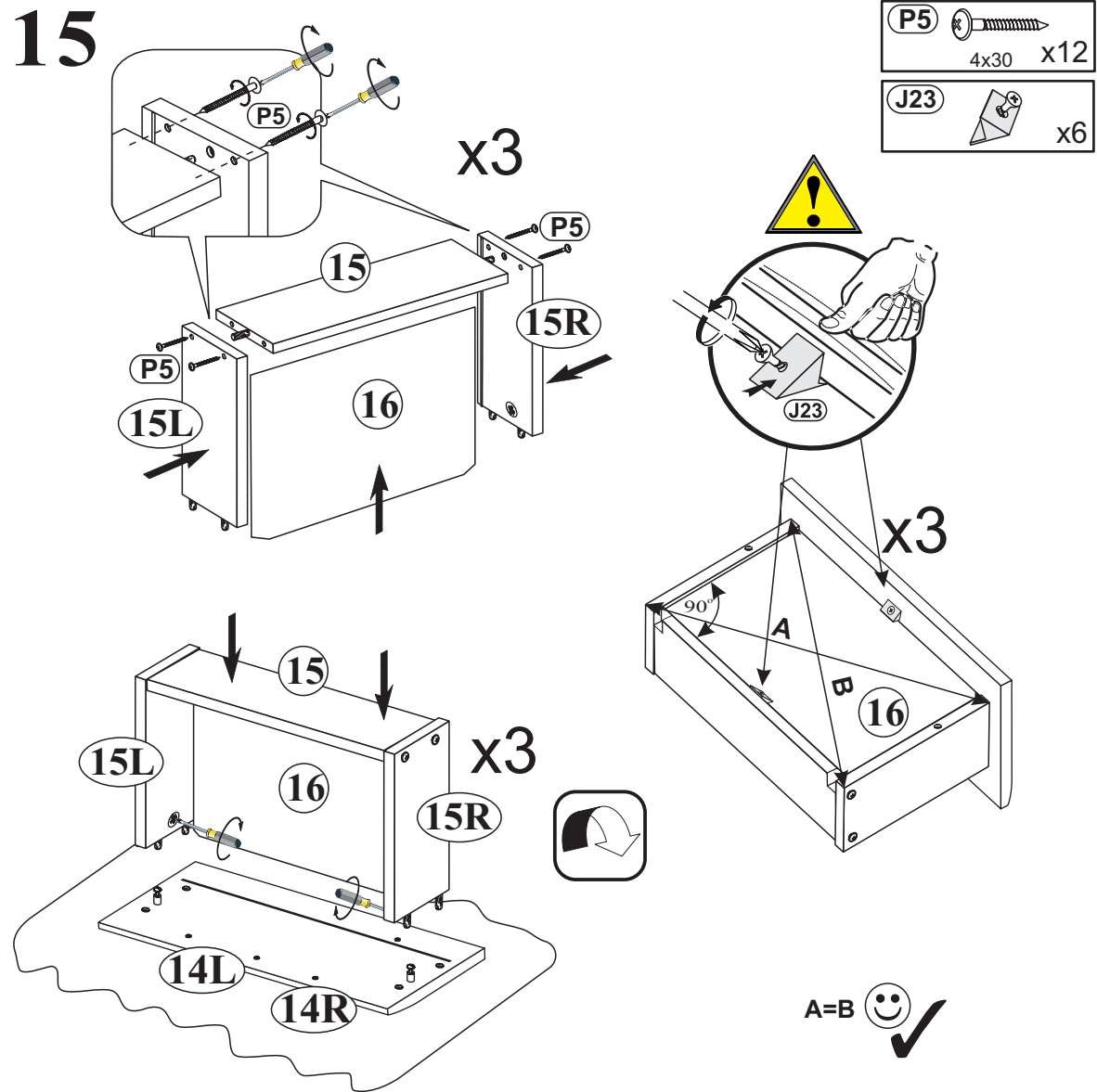

# SAVONA

# 10E6--21

# Type:21

# 13 / 14

## 16

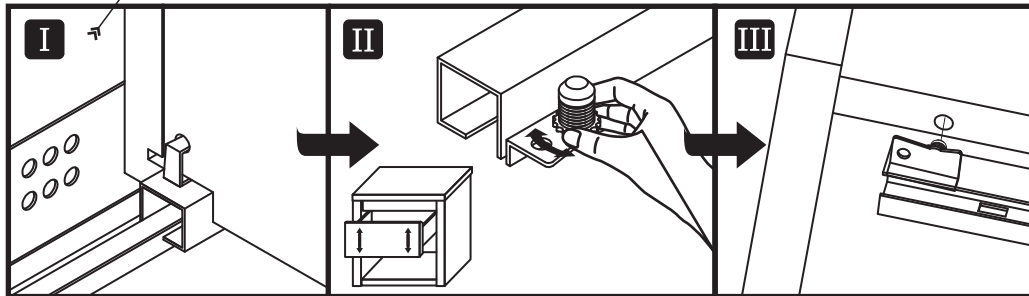
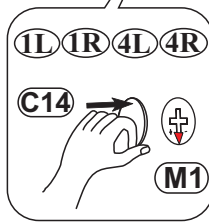
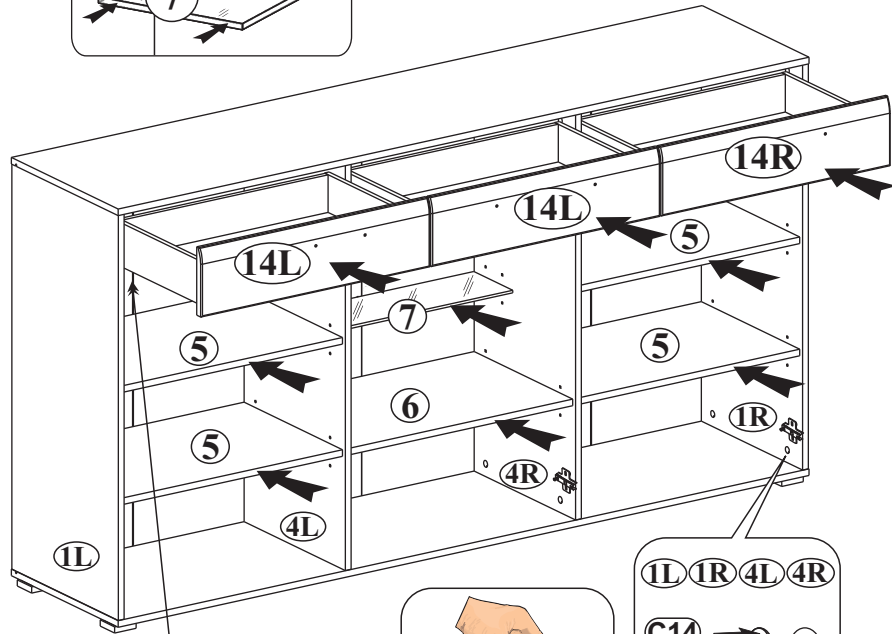
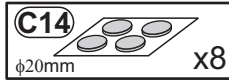
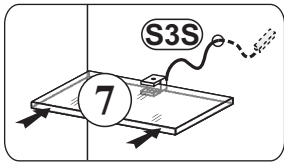

## 17

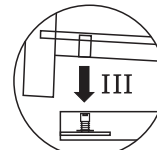
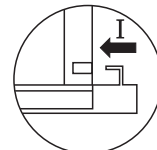
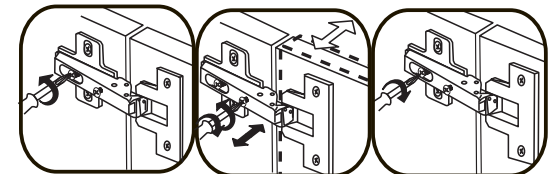
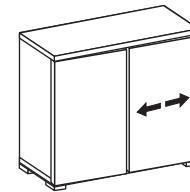
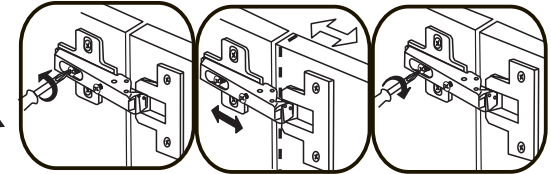
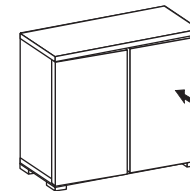
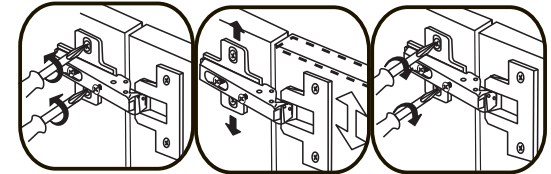
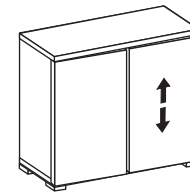
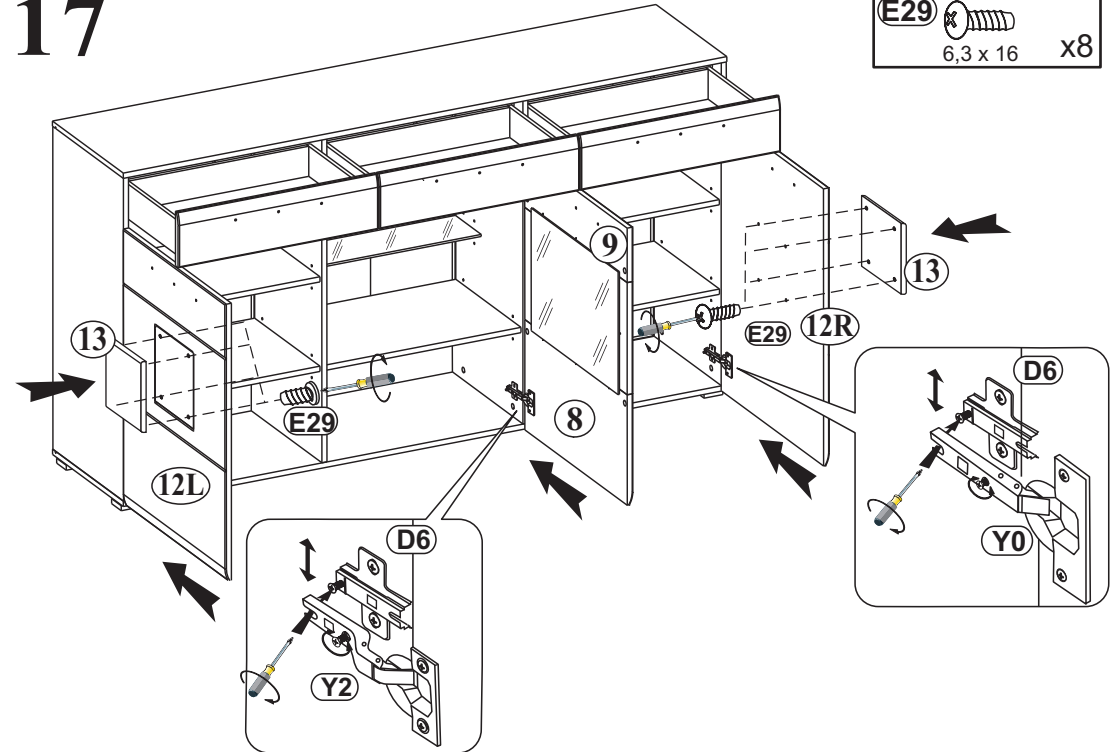
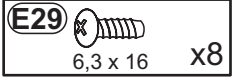

18

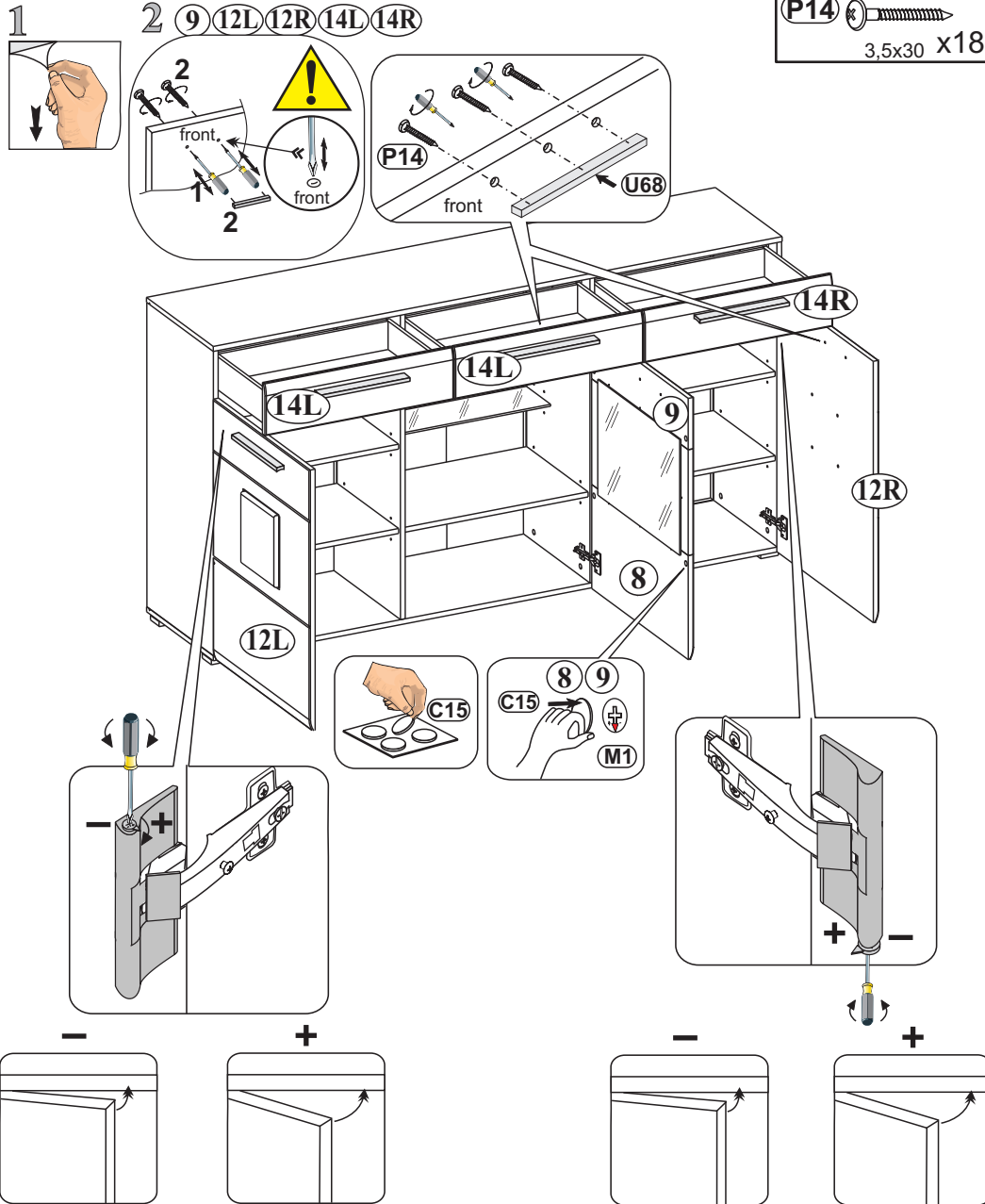
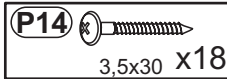
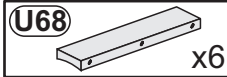
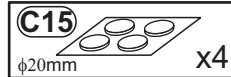

19

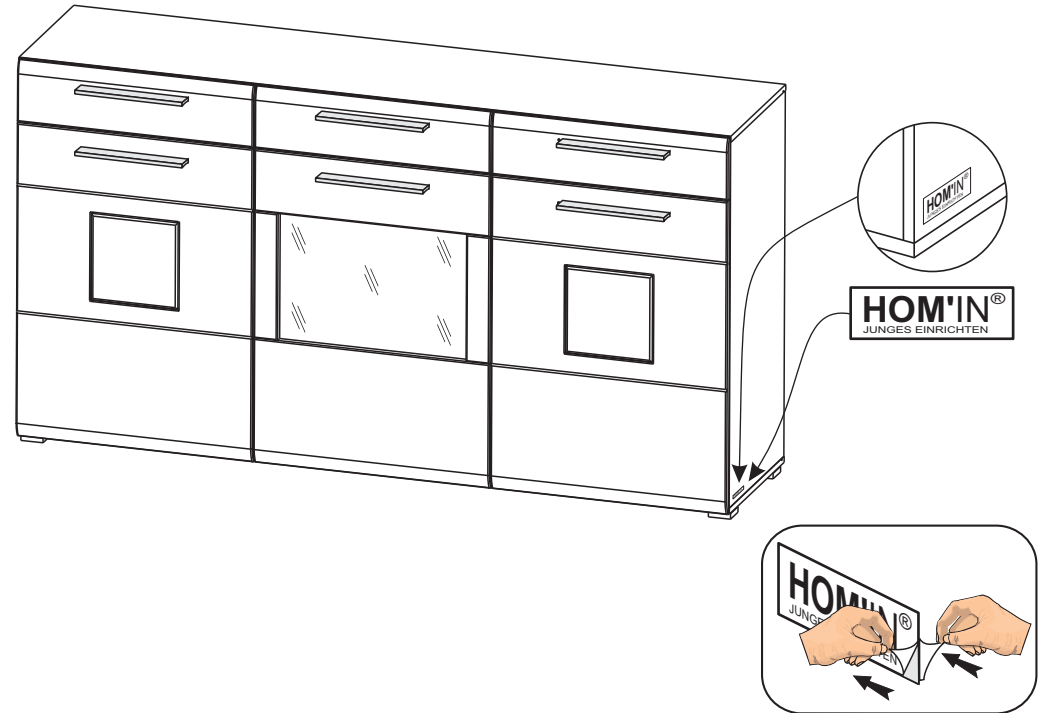



**D CH AT LI LU** Kleinstele und Verpackungsfolien bei der Möbelmontage von Kindern fernhalten!  
**GB US** Keep small parts and plastic film out of the reach of children!  
**FR BE NC** Tenir les petites pièces et les films plastiques hors de la portée des enfants!  
**NL** Hou de kleine onderdelen en de plastic folie uit de buurt van kinderen!  
**IT** Tenere i componenti di piccole dimensioni e le pellicole di plastica fuori dalla portata dei bambini!  
**SI** Malhni delov i foliju za pakovanje priklom montaži pohištna priane izven dosega otrok!  
**XS HR BA** Mahe dijelove i foliju za pakovanje priklom montaže namještaja držite dalje od djece  
**HU** Bútorészeket közbden a kis alkatrészek és a csomagoló fóliák gyerekektől távol tartandók!  
**BG** Дребни детайли и опаковъчни фолиа да се държат далеч от деца при монтажа на мебелите!  
**CZ SK** Vid montáži nábytku uchovávejte drobné díly a obalové fólie z dosahu dětí!  
**SE** Vid möbelföringen ska smådelar och förpackningsfolien hållas oåtkomliga för barn!  
**RO** Țineți departe de copil piesele mici și folia de ambalat la montarea mobilierului!  
**ES** ¡Durante el montaje, mantenga alejados de los niños las piezas pequeñas y el material plástico de embalaje!

**D CH AT LI LU** Möbelmontage muss auf ebennem Untergrund erfolgen. Bei Wandmontagen immer geeignetes Befestigungsmaterial verwenden.  
**GB US** Furniture must be assembled on a flat surface. For assembly to the wall only use suitable fixing materials.  
**FR BE NC** Le meuble doit être monté sur une surface plane. Pour le montage mural, utilisez des accessoires de fixation adaptés au type de mur.  
**NL** De meubels dienen op een vlakke ondergrond te worden gemonteerd. Voor wandmontage moeten geschikte bevestigingsmaterialen worden gebruikt.  
**IT** Il montaggio dei mobili deve avvenire su un fondo piano. Per il montaggio si prega di utilizzare solo materiali adatti.  
**SI** Pohištvo je treba montirati na ravni podlagi. Pri stenski montaži vedno uporabite pritrilveni material.  
**XS HR BA** Namještaj se mora montirati na ravnoj podlozi. Kod montaže na zid uvijek koristite prikladan materijal za pričvršćivanje.  
**HU** A bútorcszerelési silk felületen kell végezni. Falra szereléshez mindig megfelelő rögzítianyagot kell használni.  
**BG** Материалът на мебелите да се извършва на равна основа. При стенен монтаж винаги да се използва подходящ крепежен материал.  
**CZ SK** Montáž nábytku provádějte na rovném podkladu. Při montáži na stěnu používejte vždy vhodný příslušovací materiál.  
**SE** Monteringen av möbelen måste göras på jämnt underlag. Vid väggmontering ska lämpligt uppfästingsmaterial användas.  
**RO** Montarea mobilier trebuie să se realizeze pe o pardoseală dreaptă. La montarea la perete utilizați întotdeauna material de fixare adecvat.  
**ES** El montaje debe efectuarse sobre una superficie uniforme. En el montaje mural emplee siempre el material de fijación adecuado.

**D CH AT LI LU** Bitte beachten Sie die Montageanleitung. Halten Sie immer die angegebene Wattzahl ein. Verhindern Sie einen Hitzestau.  
**GB US** Please observe the assembly instructions. Do not exceed the max. given wattage. Ensure that the heat is not allowed to build up.  
**FR BE NC** Veuillez respecter la notice de montage. Respectez impérativement le nombre des watts maximal. Veillez à éviter toute accumulation de chaleur.  
**NL** Lees a.u.b. de montagehandleiding door. Hou de beslist aan het max. opgegeven wattage. Zorg ervoor dat geen hittehuwling onstaat.  
**IT** Attenersi alle istruzioni di montaggio. Rispettarsi rigorosamente il numero di watt max. indicato. Assicurarsi che non si verifichi un accumolo di calore.  
**SI** Upoštevajte navodila za montažo. Vedno upoštevajte navedeno število vatov. Preprečite zastoj vročine.  
**XS HR BA** Obratite pažnju! Vas pozor na uputu za montažu. Uvijek se pridržavajte navedenog broja vati. Izbjegavajte zastoj vrućine.  
**HU** Vegye figyelembe a szerelési útmutatót. Mindig tartsa be a megadott wattszámot. Akadályozza meg a hőelődést.  
**BG** Моля, вземете под внимание ръководството за монтаж. Спазвайте винаги посочените ватове. Избягвайте акумулиране на топлина.  
**CZ SK** Dodržujte prosím návod k montáži. Vždy dodržujte uvedenou hodnotu výkonu (watt). Zabráňte tak přehřívání.  
**SE** Följ monteringsanvisningen. Följ alltid angivet watttal. Undvik att hetta uppstår.  
**RO** Respectați instrucțiunile de montaj. Respectați întotdeauna numărul de watt impus. Evitați acumularea de căldură.  
**ES** Le rogamos que tenga presente las instrucciones de montaje. Respete siempre el número indicado de vatios. Evite la acumulación de calor.

**D CH AT LI LU** Halten Sie die max. zulässigen Belastungswerte der Möbelteile ein. Details siehe Montageanleitung  
**GB US** Comply with the max. permissible loads. For details, please refer to the assembly instructions  
**FR BE NC** Respectez les valeurs de charge max. admissibles des parties de meubles. Pour plus de détails, cf. la notice de  
**NL** Hou de maximaal geoorloofde belastingwaarden van de meubeldelen aan. Voor details verwijzen wij naar de montagehandleiding  
**IT** Rispettare la portata max. permessa degli elementi del mobile. Per dettagli si vedano le istruzioni di montaggio e si vada  
**SI** Upoštevajte največjo dovoljeno obremenitev delov pohištna. Podrobnosti najdete v navodilih za montažo in na  
**XS HR BA** Tartsa be a bútorelemek max. megengedett terhelési értékét. A részleteket lásd a szerelési útmutatóban  
**HU** Snaazaita max. dopustimite stoinosti na natovaravne na mebelite. Za podrobnosti vjvj ръководството за монтаж  
**BG** Додръжте max. prípustnê hodnotu zaitženi nábykových dílů. Podrobnosti viz návod k montáži  
**CZ SK** Dodržujte max. přípustnê hodnotu zaitženi nábykových dílů. Podrobnosti viz návod k montáži  
**SE** Följ max. tillåten belastning av möbeldelarna. Mer information finns i monteringsanvisningen  
**RO** Respectați valorile de solicitare max. admise pentru corpurile de mobilier. Pentru detalii consultați instrucțiunile de montaj  
**ES** Respete los valores máximos de carga admisibles para las piezas de los muebles. Consulte los detalles en las instrucciones

**D CH AT LI LU** Zur Möbelfeinigung ein mit Wasser befeuchtetes, fusselfreies Baumwolltuch verwenden. Geeignigte Flächen immer trockenreiben!  
**GB US** To clean the furniture only use a water dampened lint-free cotton cloth. Once cleaned, always wipe the surfaces dry.  
**FR BE NC** Utilisez un chiffon en coton non pelucheux humidifié avec de l'eau pour nettoyer les meubles. Séchez systématiquement les surfaces  
**NL** nettoyées en les frottant!  
**IT** Gebrauk een met water bevochtigde, pluusvrije katoenen doek om de meubels te reinigen. Wrijf gereinigde oppervlakken altijd droog!  
**SI** Per pulire il mobile utilizzare un panno di cotone inumidito d'acqua e che non perde pelucchi. Asciugare sempre le superfici che si sono  
**XS HR BA** kromi!  
**HU** Za čišćenje pohištna uporabljajte vlažno bombažno krpo, ki ne pušča vlaken. Očišćene površine vedno obrišite do suhnegai  
**BG** Za čišćenje namještaja koristite sa vodom navlaženu pamučnu krpu koja ne ispušta vlakna. Očišćene površine uvijek obrišite suhom  
**CZ SK** K čištění nábytku používejte bavlněný hadr neuvolňující vlákna, navlhčený ve vodě. Učištěné plochy vždy utřete do sucha!  
**SE** För möbelföring används en luddfri bomullsduk fuktad med vatten. Rengörda ytor ska alltid torftas torra!  
**RO** Pentru curățarea mobilierului, utilizați o lavetă din bumbac fără saame umezită cu apă. Suprafețele curățate se șterg întotdeauna până se  
**ES** Emplee un paño de algodón humedecido con agua y libre de pelusa para la limpieza de los muebles. ¡Seque siempre las superficies que ha limpiado!