

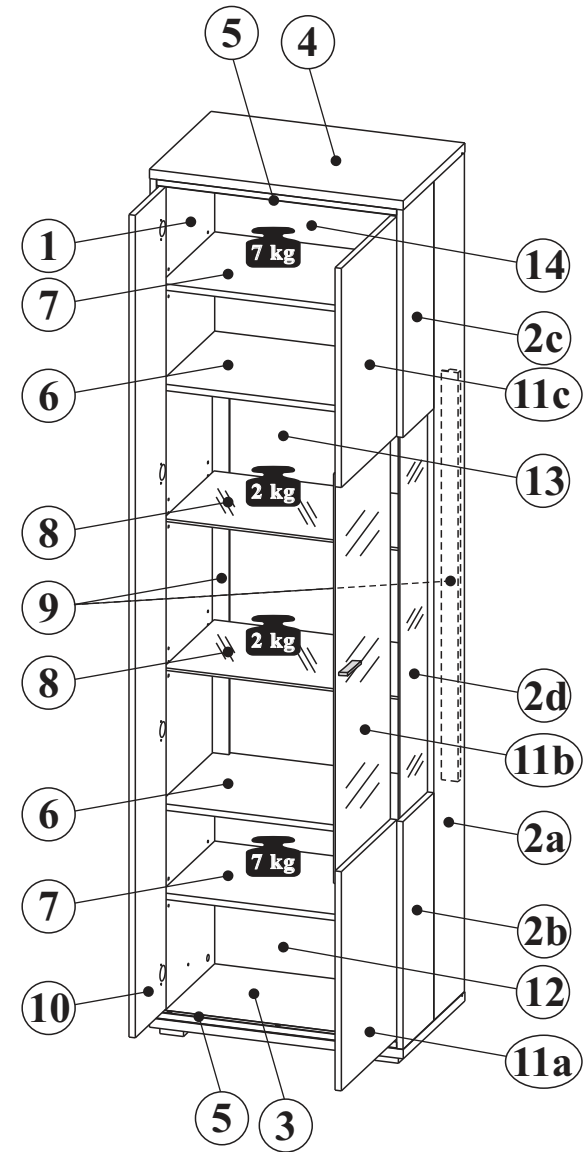

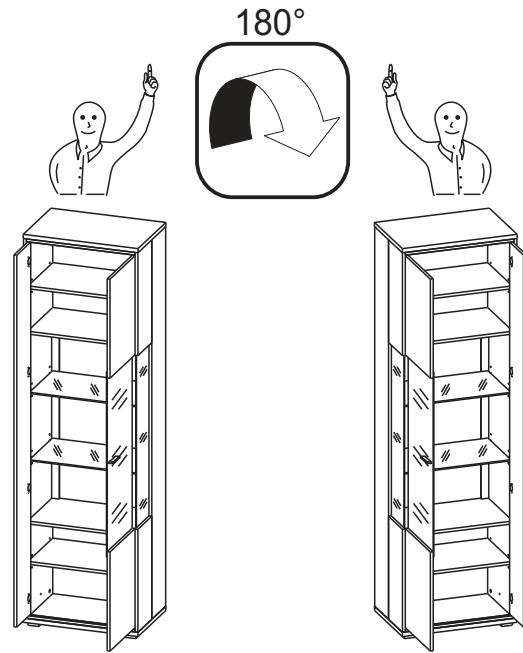

B - 600mm  
H - 2048mm  
T - 400mm

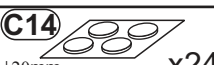

<b>B1</b> φ 8x28 x16	<b>S2A</b> 4x30 x6		
<b>B20</b> φ 8x50 x4	<b>XX</b> x2	<b>G4</b> L-4,5 φ 7 x6	<b>X13</b> φ 35 Kr15 x8
<b>M1</b> φ 15x12mm x24	<b>J23</b> x18	<b>P31</b> 3,5x16 x12	<b>PH</b> H2 x8
<b>T1</b> 5x39mm x16	<b>P2</b> 3x20 x4	<b>G5</b> x3	<b>E3</b> 6,3x13 x16
<b>T12</b> L-48 x4	<b>F1</b> x4	<b>S6</b> 3x20 x3	<b>S8</b> 4x13 x16

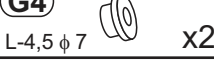
<b>NR 1</b> <b>C14</b> φ20mm x24  <b>U169</b> x1  <b>A4</b> M4x12 x2  <b>G4</b> L-4,5 φ 7 x2  <b>W3</b> x8  <b>W1</b> x8 	<b>NR 2</b> <b>N20</b> x4  <b>S2</b> 4x30 x8 	<b>NR 3</b> <b>J11</b> x1  <b>P13</b> 3,5x13 x2  <b>T13</b> 8x50 mm x1  <b>T14</b> 6x50 mm x1 
---	---	--

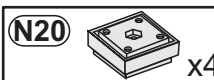
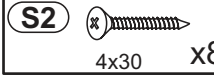
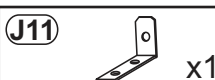
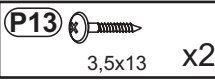
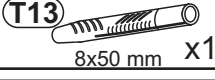
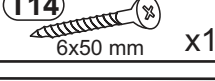
**C 1/1**



1

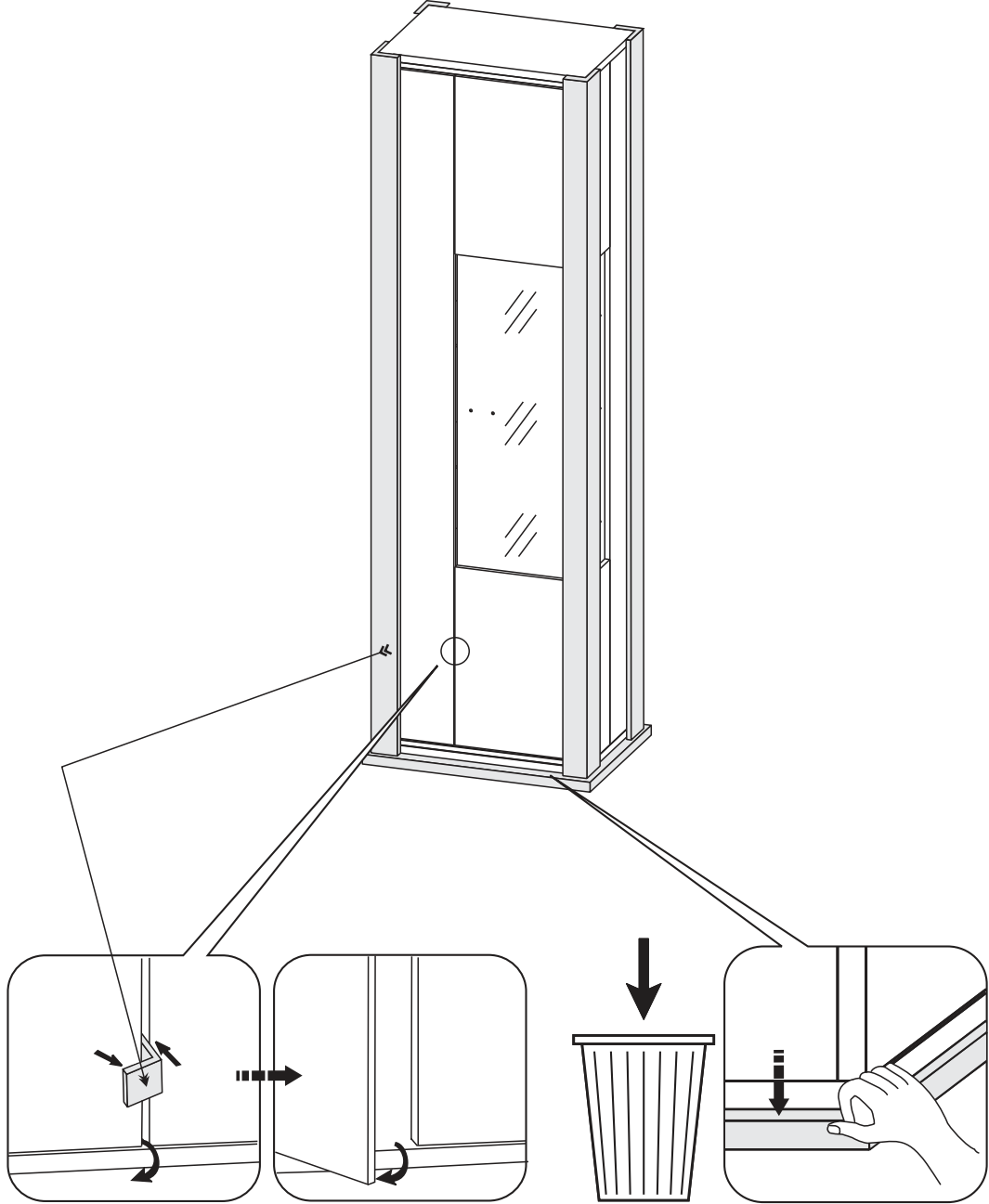

2

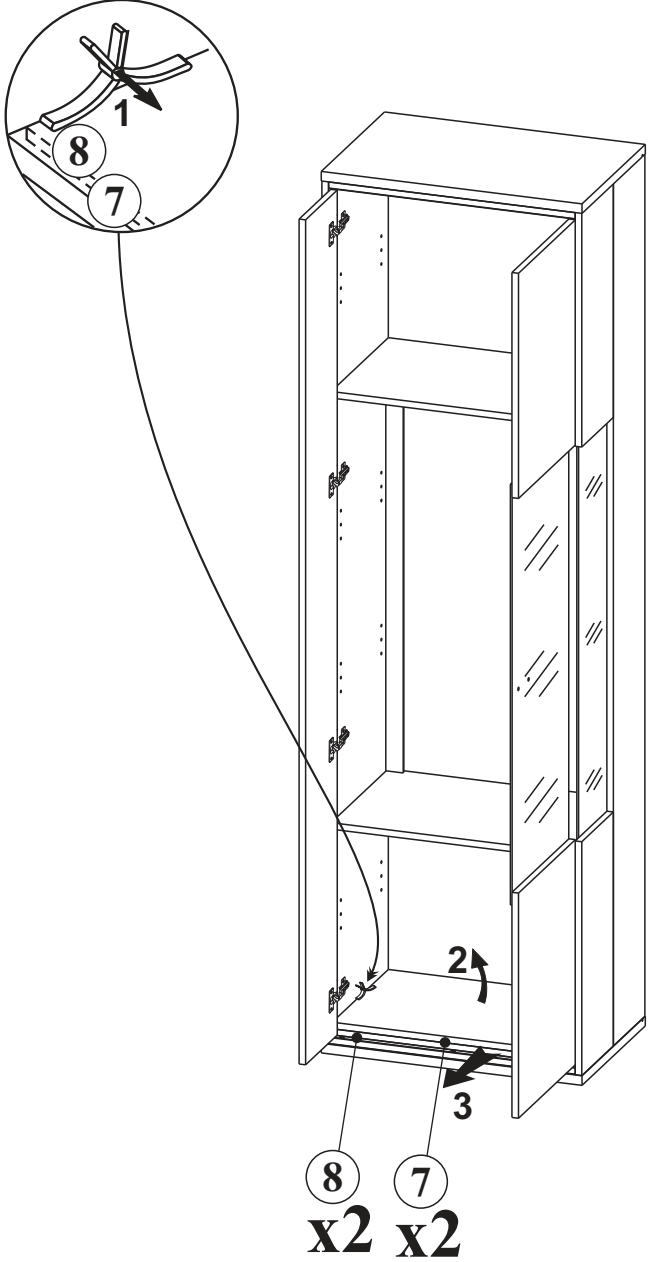

## 3a

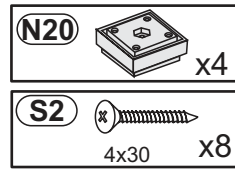
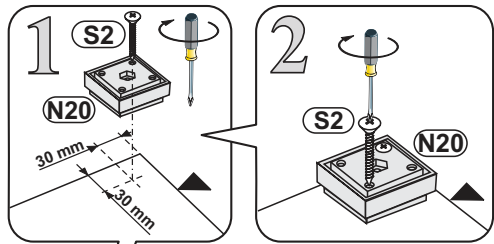
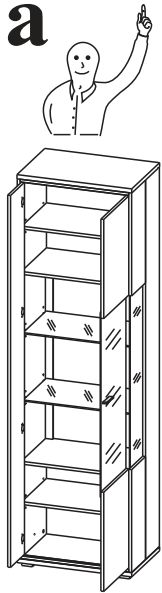

## 3b

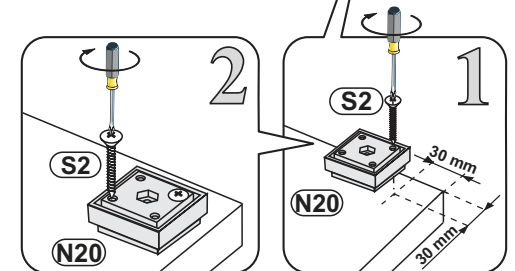
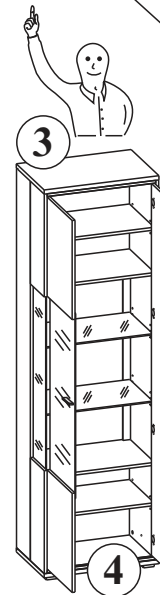
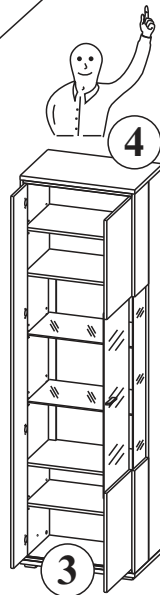
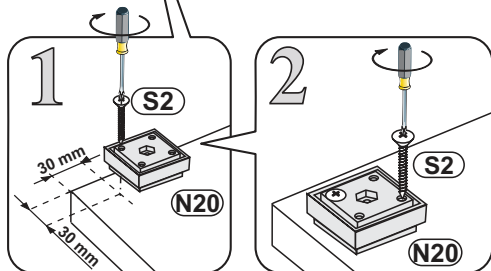
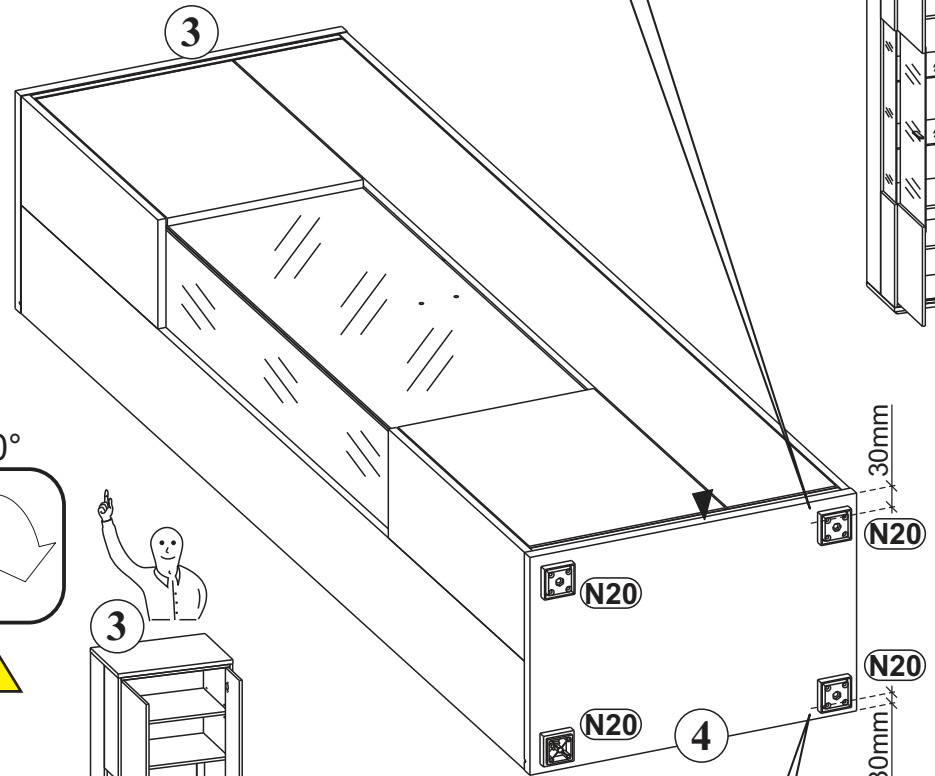
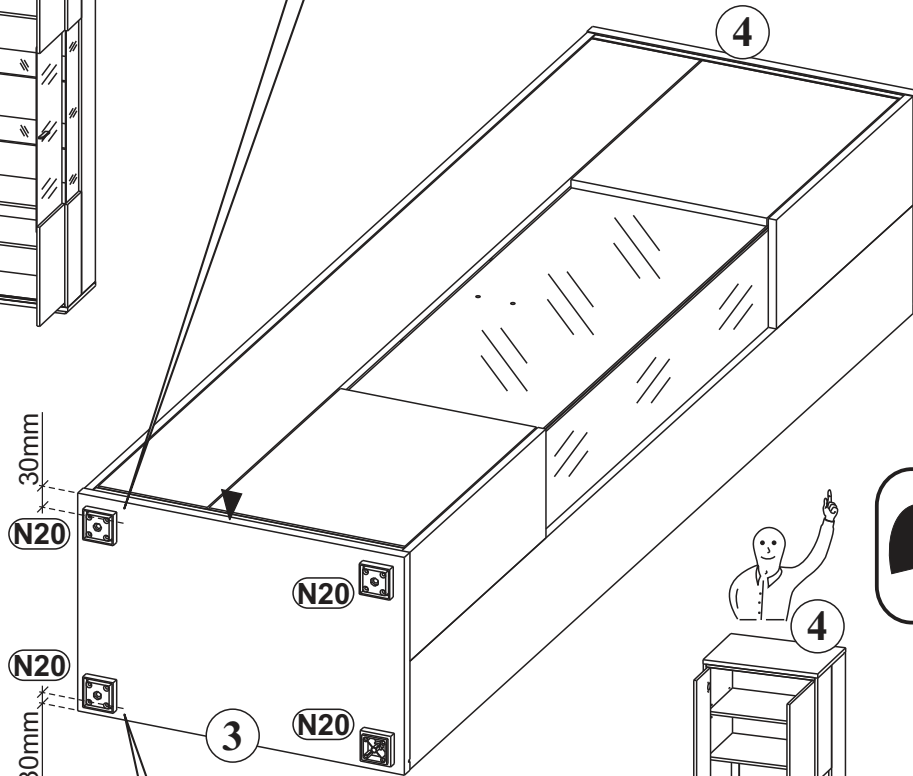
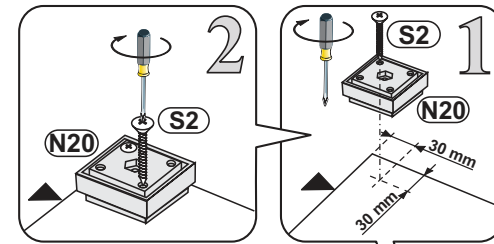
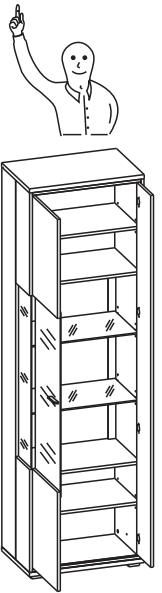

4a

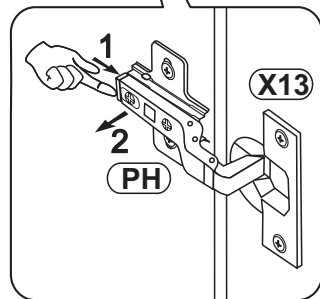
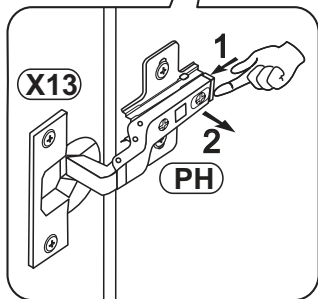
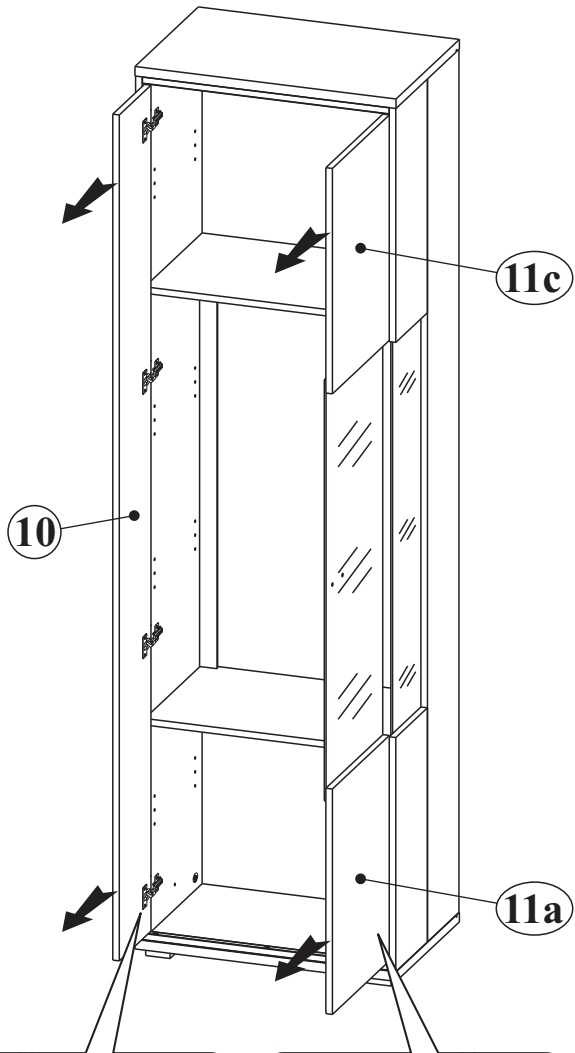
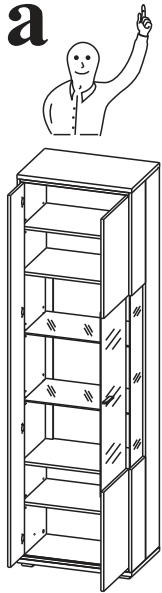

4b

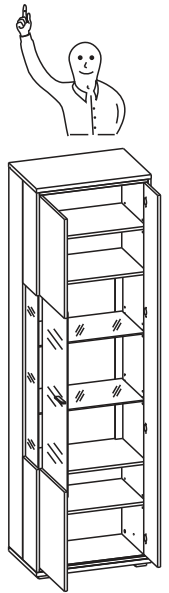
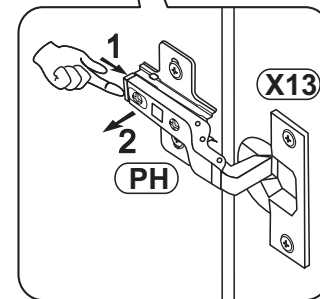
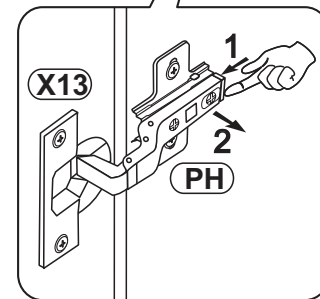
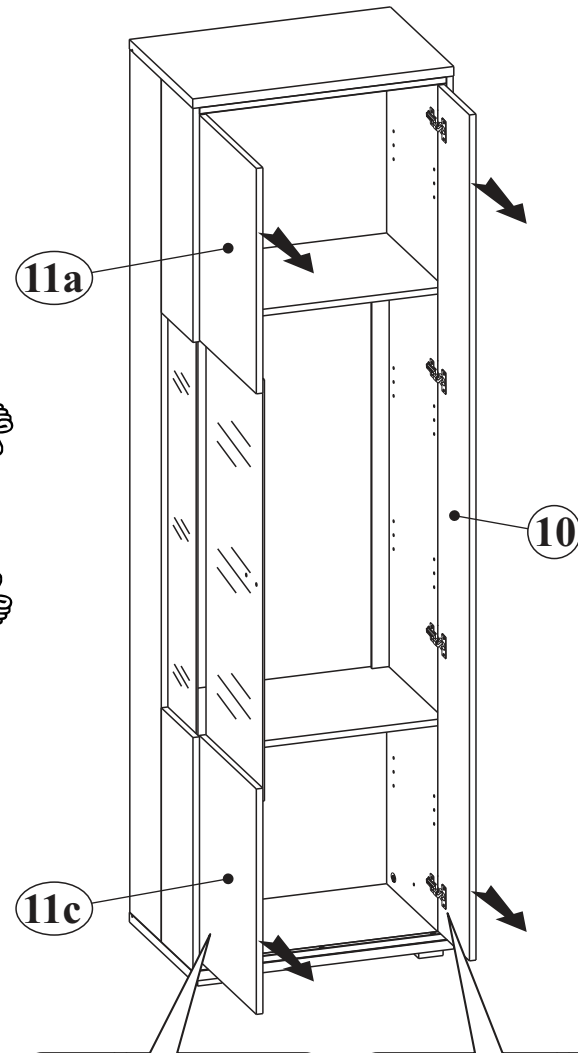
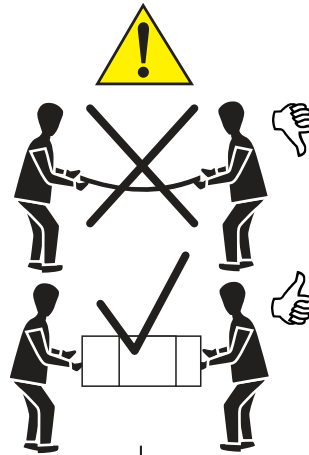

5a

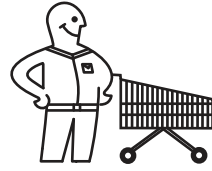
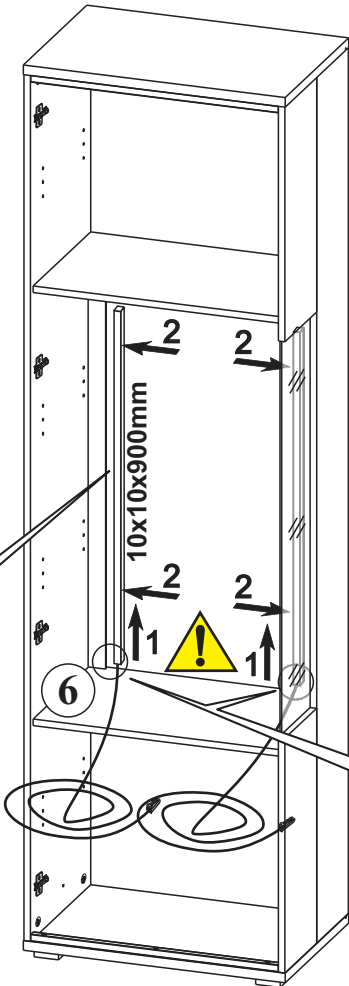
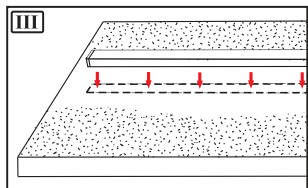
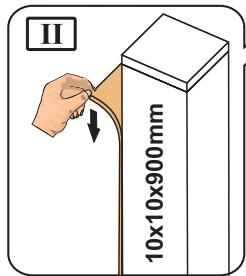
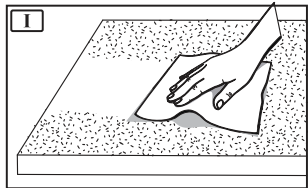
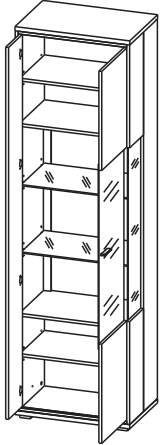

OPTION MIT BELEUCHTUNG  
40 78 HH 97

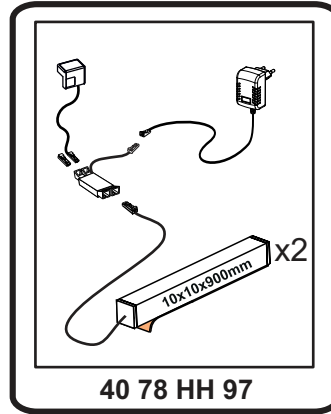

5b

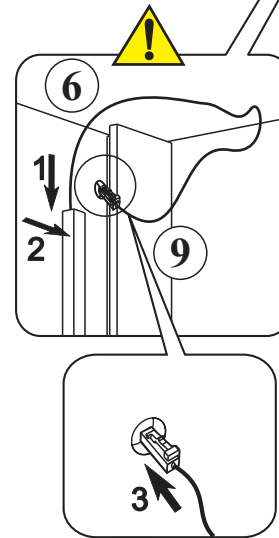
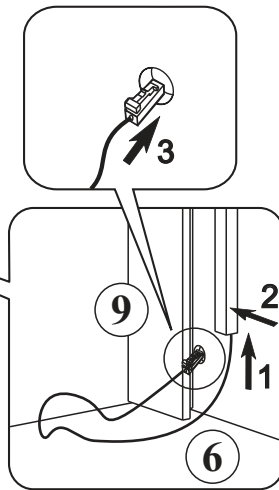
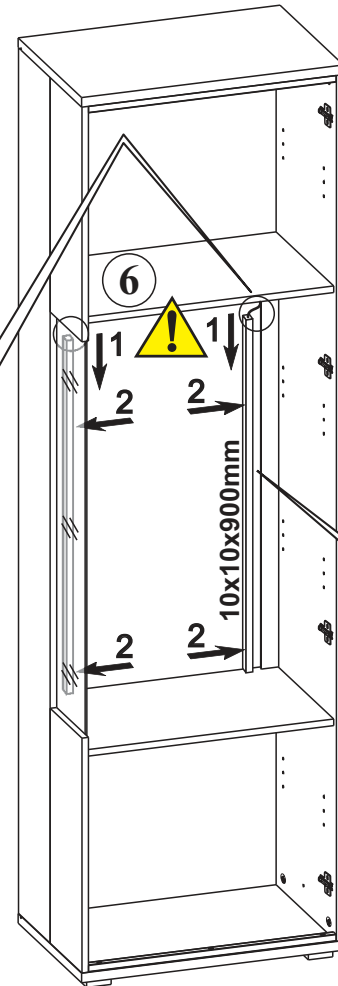
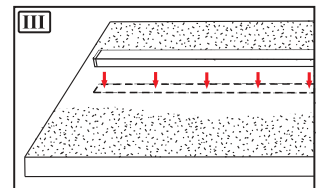
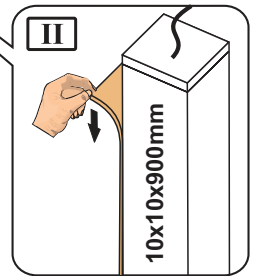
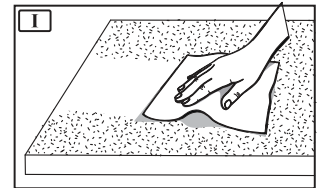
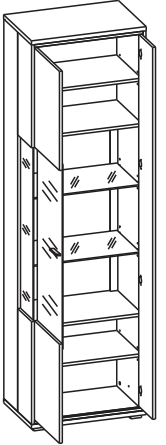

5c

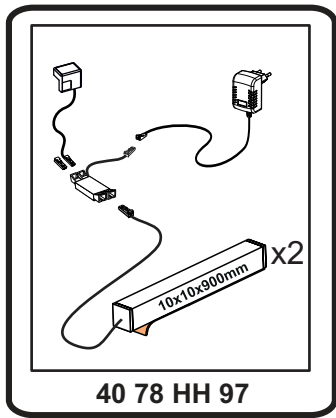

OPTION MIT BELEUCHTUNG

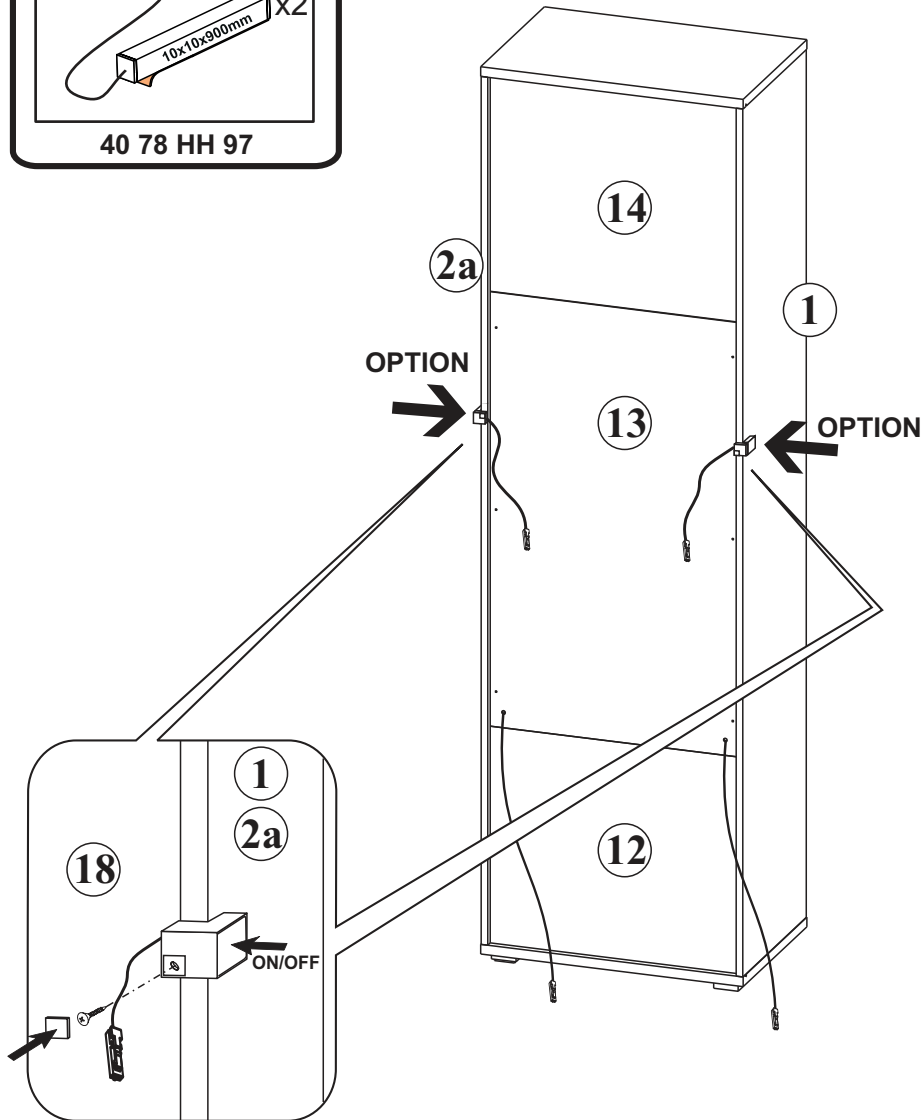

5d

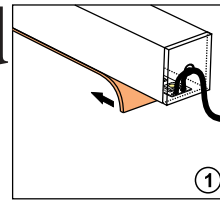

OPTION MIT BELEUCHTUNG  
40 78 HH 97

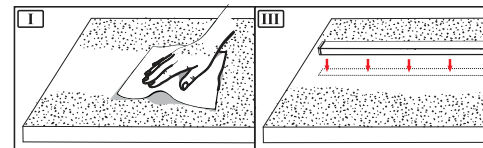
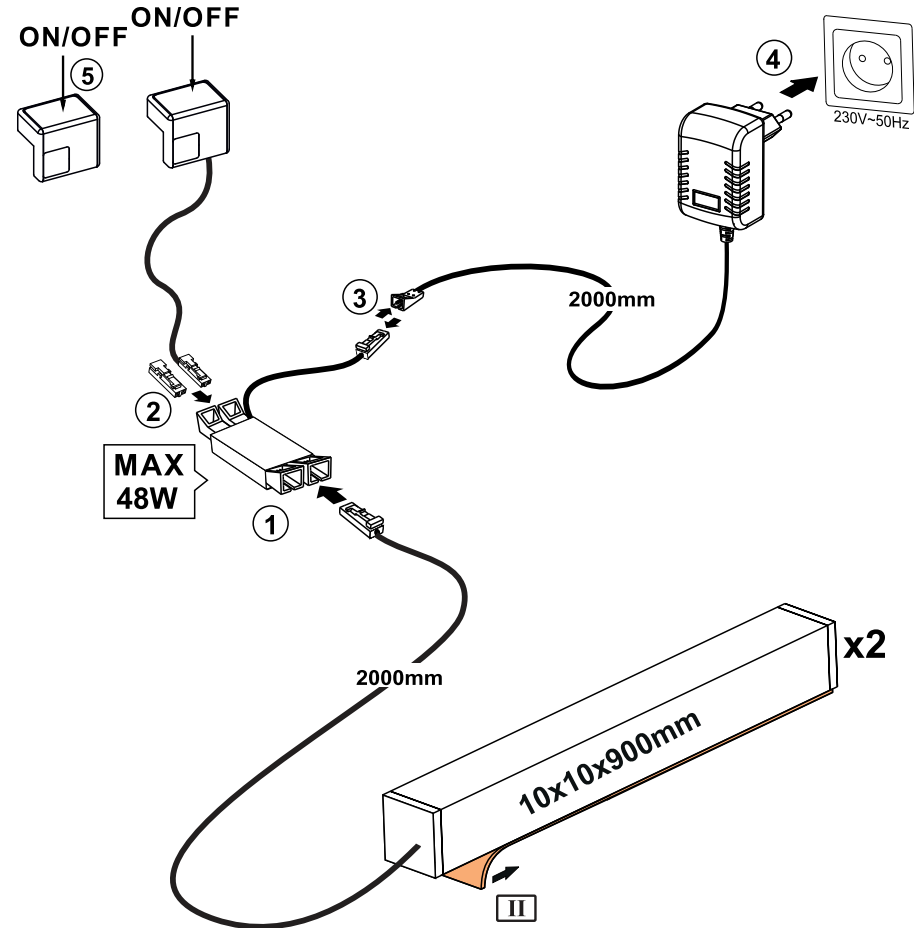



- 6** **T14** 6x50 mm x1
- T13** 8x50 mm x1
- P13** 3,5x13 x2
- J11** x1

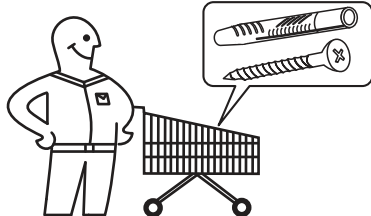
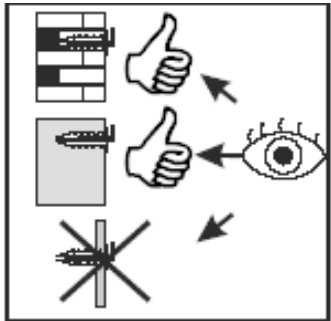
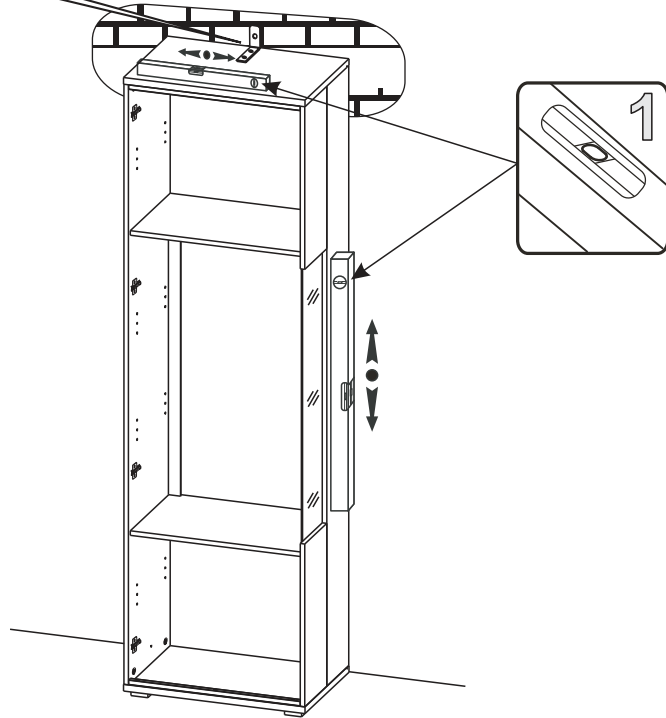
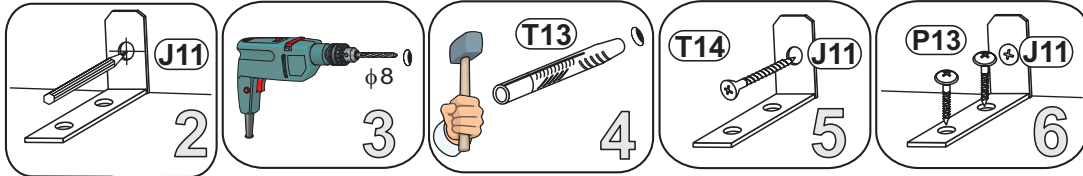

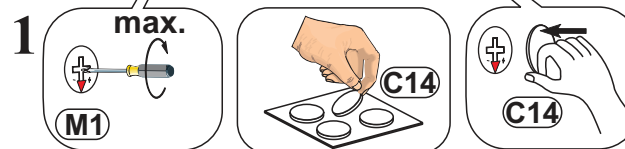
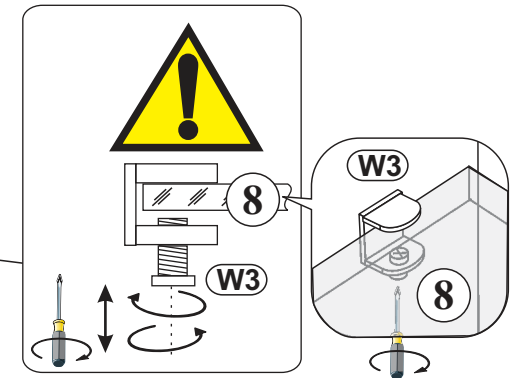
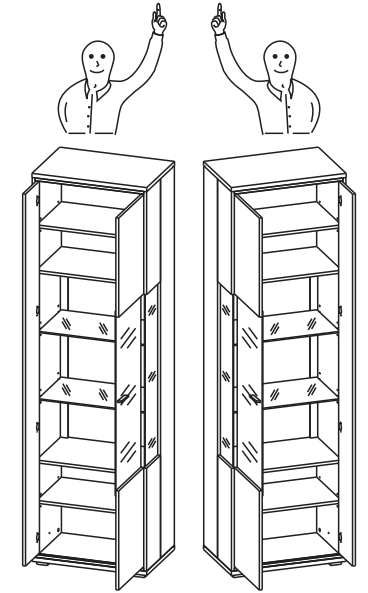
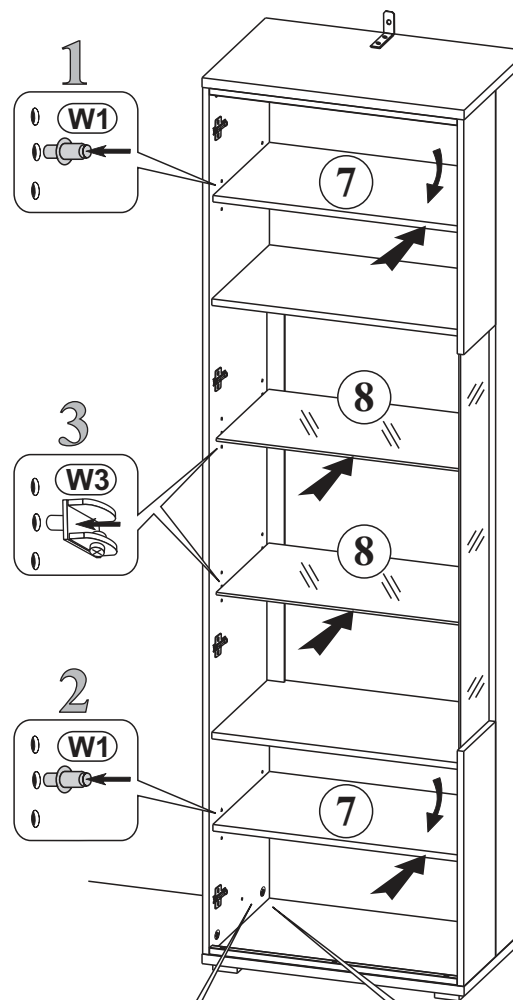

- 7** **C14** phi20mm x24
- W3** x8
- W1** x8

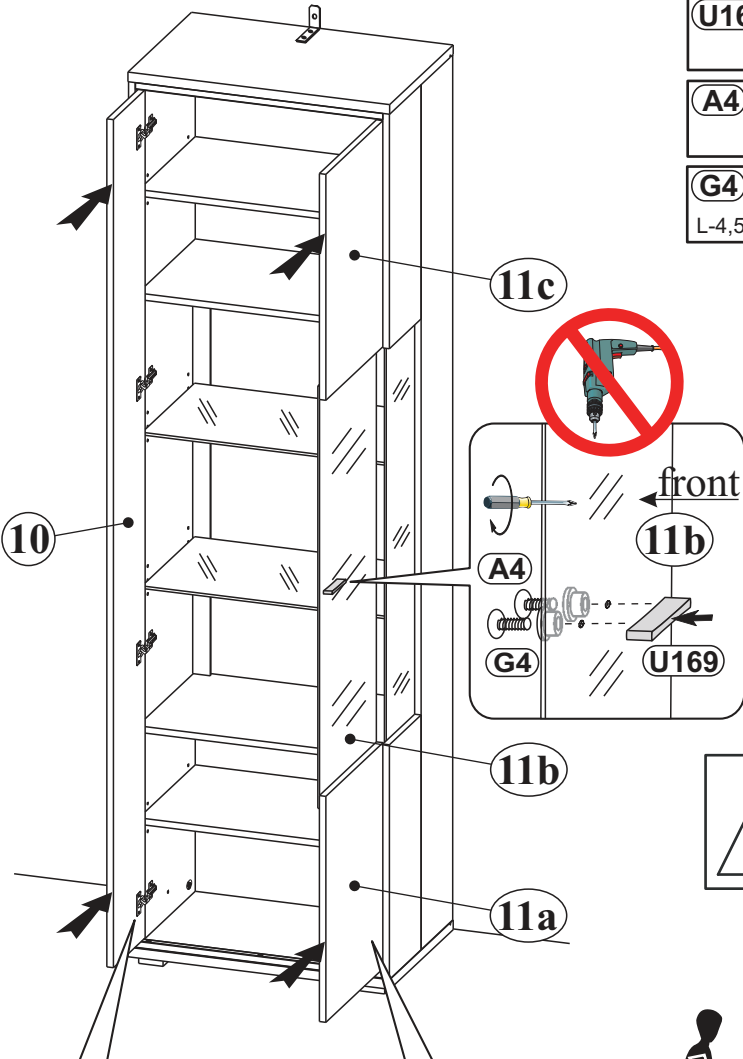
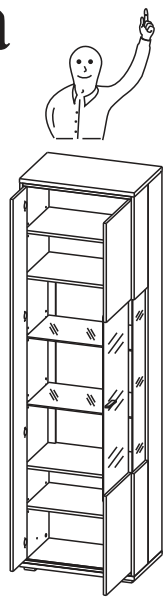

8a

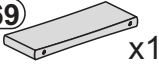

- U169**  x1
- A4**  M4x12 x2
- G4**  L-4,5 φ 7 x2

8b

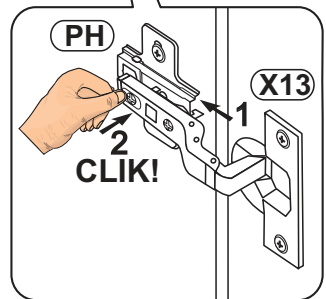
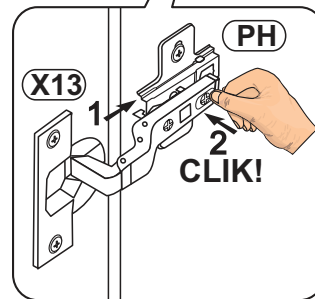
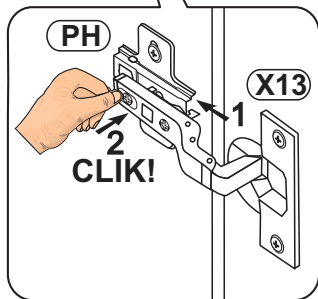
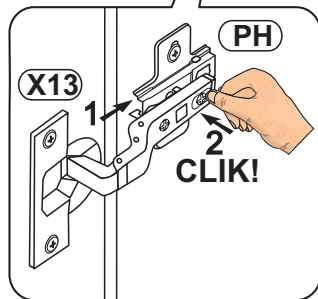
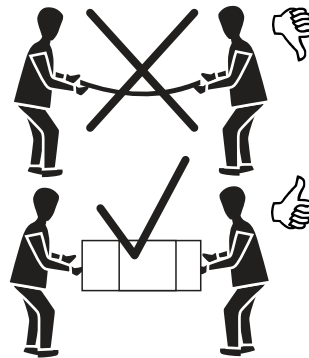
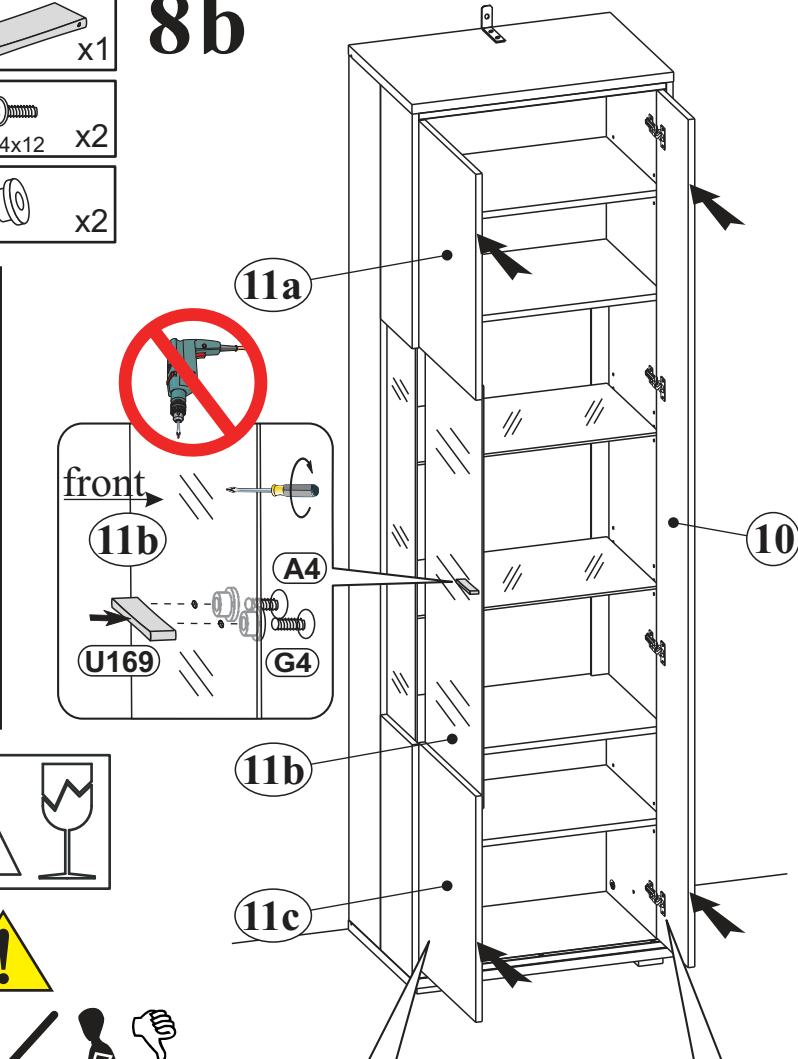
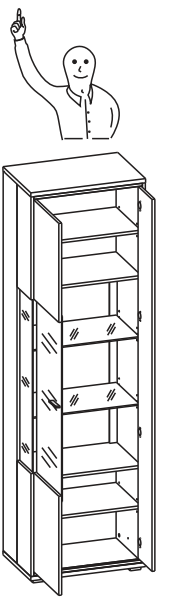

# 9

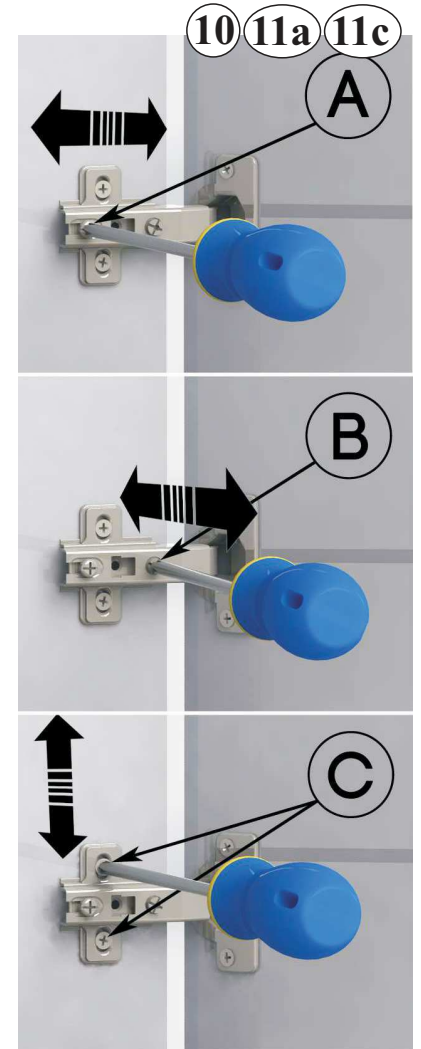
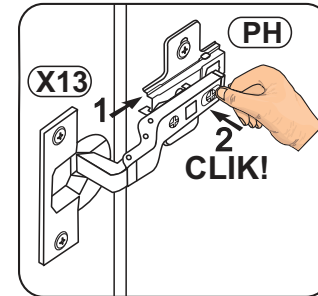
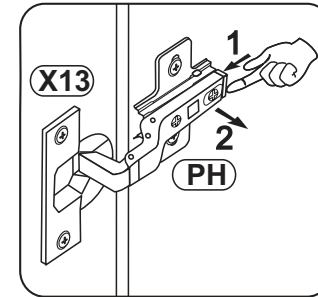
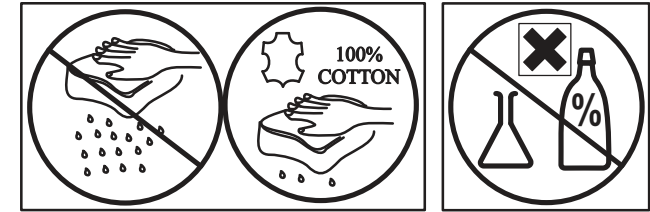
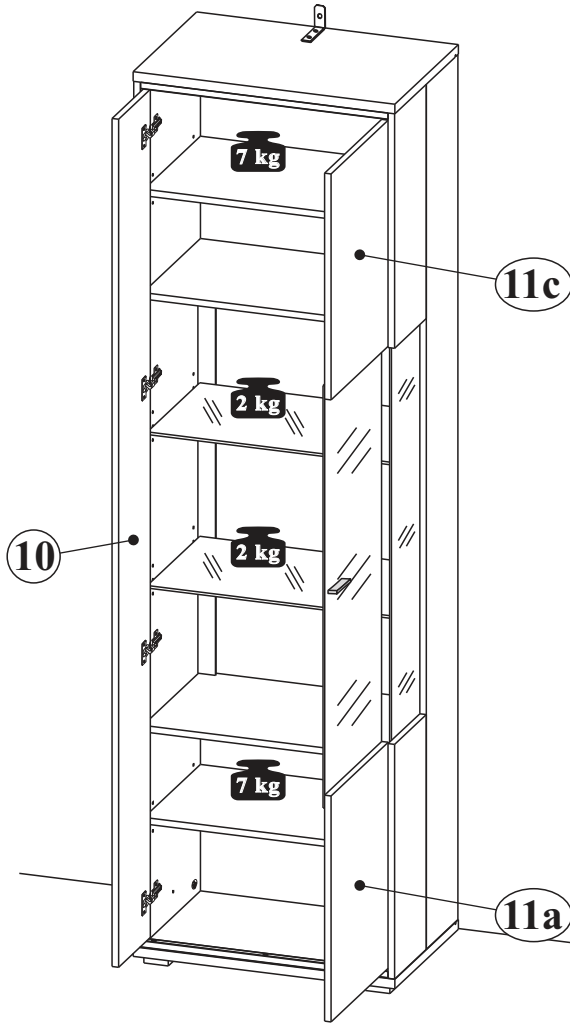
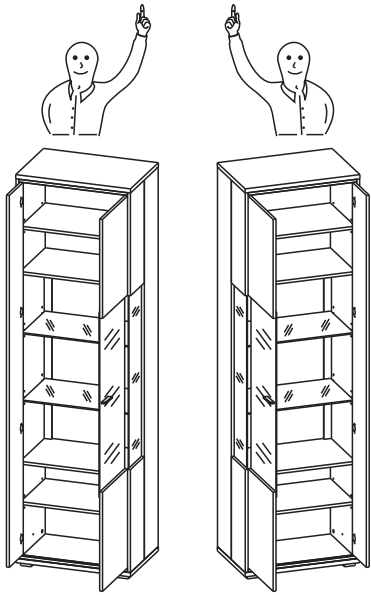

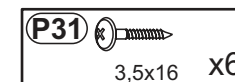
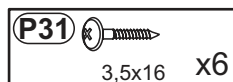
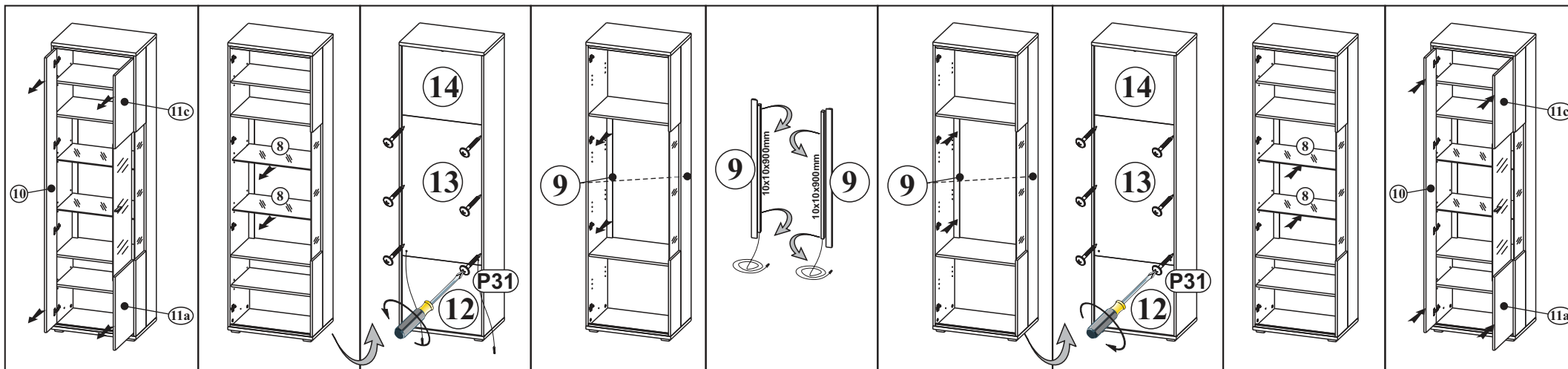

## OPTION MIT BELEUCHTUNG 40 78 HH 97

787718 FS-2835-60D-WW

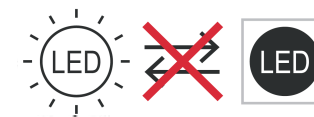

<b>PL-</b> Ten produkt zawiera źródła światła o klasie efektywności energetycznej „E”	<b>DE-</b> Diese Produkte enthalten Lichtquellen der Energieeffizienzklasse „E”	<b>CS-</b> Tento výrobek obsahuje světelný zdroj třídy energetické účinnosti „E”
<b>DA-</b> Dette produkt indeholder en lyskilde til energieffektivitetsklasse „E”	<b>EL-</b> Αυτό το προϊόν περιέχει μια πηγή φωτεινής πηγής ενεργειακής απόδοσης „E”	<b>EN-</b> This product contains a light sources of energy efficiency class „E”
<b>ES-</b> Este producto contiene una fuente de luz de clase de eficiencia energética „E”	<b>ET-</b> See toode sisaldab efektiivsusklassi valgusallikat energia "E”	<b>FI-</b> Tämä tuote sisältää energiatehokkuusluokan valonlähteen „E”
<b>FR-</b> Ce produit contient des sources lumineuses de classe d'efficacité „E”	<b>HU-</b> Ez a termék energiahatékonysági osztályú fényforrást tartalmaz „E”	<b>IT-</b> Questo prodotto contiene una sorgente luminosa di classe di efficienza energetica „E”
<b>LT-</b> Šiame gaminyje yra energijos vartojimo efektyvumo klasės šviesos šaltinis „E”	<b>LV-</b> Šis produkts satur gaismas avotu ar energoefektivitātes klasi „E”	<b>RU-</b> Этот продукт содержит источник света класса энергоэффективности „E”
<b>PT-</b> Este produto contém uma fonte de luz da classe de eficiência energética „E”	<b>RO-</b> Acest produs conține o sursă de lumină de clasă de eficiență energetică „E”	<b>NL-</b> Dit product bevat een lichtbron met energie-efficiëntieklasse „E”
<b>SK-</b> Tento výrobok obsahuje svetelný zdroj triedy energetickej účinnosti „E”	<b>SLO-</b> Ta izdelek vsebuje svetlobni vir razreda energijske učinkovitosti „E”	<b>SV-</b> Denna produkt innehåller en ljuskälla för energieffektivitetsklass „E”
<b>TR-</b> Bu ürün bir ışık kaynağı enerji verimliliği sınıfı içerir „E”	<b>HR-</b> Ovaj proizvod sadrži izvor svjetlosti razreda energetske učinkovitosti „E”	<b>BG-</b> Този продукт съдържа източник на светлина от клас на енергийна ефективност „E”

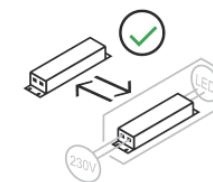

**D CH AT LI LU** Kleintelle und Verpackungsfolien bei der Möbelmontage von Kindern fernhalten!  
**GB US** Keep small parts and plastic film out of the reach of children!  
**FR BE NC** Tenir les petites pièces et les films plastiques hors de la portée des enfants!  
**NL** Hou de kleine onderdelen en de plastic folie uit de buurt van kinderen!  
**IT** Tenere i componenti di piccole dimensioni e le pellicole di plastica fuori dalla portata dei bambini!  
**SI** Malne delov in embalažne folije pri montaži pohištva hranite izven dosega otrok!  
**XS HR BA** Malje delove i foliju za pakovanje priklom montaže namještaja držite dalje od djece  
**HU** Bitorsereléshez közbén a kis alkatrészek és a csomagoló fólia gyermekékhöz távol tartandók!  
**BG** Дребни детайли и опаковъчни фолия да се държат далеч от деца при монтажа на мебелите!  
**CZ SK** Dřevní detaily i obalovací materiál při montáži nábytku uchovávejte daleko od dětí!  
**SE** Vid möbelförpackning ska smådelar och förpackningsfolien hållas oåtkomliga för barn!  
**RO** Tineți departe de copii piesele mici și folia de ambalat la montarea mobiliei!  
**ES** ¡Durante el montaje, mantenga alejados de los niños las piezas pequeñas y el material plástico de embalaje!

**D CH AT LI LU** Möbelmontage muss auf ebennem Untergrund erfolgen. Bei Wandmontagen immer geeignetes Befestigungsmaterial verwenden.  
**GB US** Furniture must be assembled on a flat surface. For assembly to the wall only use suitable fixing materials.  
**FR BE NC** Le meuble doit être monté sur une surface plane. Pour le montage mural, utilisez des accessoires de fixation adaptés au type de mur.  
**NL** De meubels dienen op een vlakke ondergrond te worden gemonteerd. Voor wandmontage moeten geschikte bevestigingsmaterialen worden gebruikt.  
**IT** Il montaggio dei mobili deve avvenire su un fondo piano. Per il montaggio si prega di utilizzare solo materiali adatti.  
**SI** Pohištvo je treba montirati na ravni podlagi. Pri stenski montaži vedno uporabite pritrilivni material.  
**XS HR BA** Namještaj se mora montirati na ravnoj podlozi. Kod montaže na zid uvijek koristite prikladan materijal za pričvršćivanje.  
**HU** A bútor szerelését silk felületen kell végezni. Falra szereléshez mindig megfelelő rögzítanyagot kell használni.  
**BG** Монтажът на мебелите да се извършва на равна основа. При стенен монтаж винаги да се използва подходящ крепежен материал.  
**CZ SK** Montáž nábytku provádějte na rovném podkladu. Při montáži na stěnu používejte vždy vhodný příslušovací materiál.  
**SE** Monterिंग av möbeln måste göras på jämnt underlag. Vid väggmontering ska lämpligt uppfästingsmaterial användas.  
**RO** Montarea mobiliei trebuie să se realizeze pe o pardoseală dreaptă. La montarea la perete utilizați întotdeauna material de fixare adecvat.  
**ES** El montaje debe efectuarse sobre una superficie uniforme. En el montaje mural emplee siempre el material de fijación adecuado.

**D CH AT LI LU** Bitte beachten Sie die Montageanleitung. Halten Sie immer die angegebene Wattzahl ein. Verhindern Sie einen Hitzestau.  
**GB US** Please observe the assembly instructions. Do not exceed the max. given wattage. Ensure that the heat is not allowed to build up.  
**FR BE NC** Veuillez respecter la notice de montage. Respectez impérativement le nombre des watts maximal. Veillez à éviter toute accumulation de chaleur.  
**NL** Lees a.u.b. de montagehandleiding door. Hou de beslist aan het max. opgegeven wattage. Zorg ervoor dat geen hittehuizing onstaat.  
**IT** Attenersi alle istruzioni di montaggio. Rispettarsi rigorosamente il numero di watt max. indicato. Assicurarsi che non si verifichi un accumulo di calore.  
**SI** Upoštevajte navodila za montažo. Vedno upoštevajte navedeno število vatov. Preprečite zastoj vročine.  
**XS HR BA** Obratite pažnju! Vas pozor na uputu za montažu. Uvijek se pridržavajte navedenog broja vai. Izbjegavajte zastoj vrućine.  
**HU** Vegye figyelembe a szerelési útmutatót. Mindig tartsa be a megadott wattszámot. Akadályozza meg a hőelődést.  
**BG** Моля, вземете под внимание ръководството за монтаж. Спазвайте винаги посочените ватове. Избягвайте акумулиране на топлина.  
**CZ SK** Dodržujte prosím návod k montáži. Vždy dodržujte uvedenou hodnotu výkonu (watt). Zabráňte tak přehřívání.  
**SE** Följ monteringsanvisningen. Följ alltid angivet watttal. Undvik att hetta uppstår.  
**RO** Respectați instrucțiunile de montaj. Respectați întotdeauna numărul de watt impus. Evitați acumularea de căldură.  
**ES** Le rogamos que tenga presente las instrucciones de montaje. Respete siempre el número indicado de vatios. Evite la acumulación de calor.

**D CH AT LI LU** Halten Sie die max. zulässigen Belastungswerte der Möbelteile ein. Details siehe Montageanleitung  
**GB US** Comply with the max. permissible loads. For details, please refer to the assembly instructions  
**FR BE NC** Respectez les valeurs de charge max. admissibles des parties de meubles. Pour plus de détails, cf. la notice de  
**NL** Hou de maximaal geoorloofde belastingswaarden van de meubeldelen aan. Voor details verwijzen wij naar de montagehandleiding  
**IT** Rispettare la portata max. permessa degli elementi del mobile. Per dettagli si vedano le istruzioni di montaggio e si vada  
**SI** Upoštevajte največjo dovoljeno obremenitev delov pohištva. Podrobnosti najdete v navodilih za montažo in na  
**XS HR BA** Tartsa be a bitorelemek max. megdoloženih vrijednosti elemenata namještaja. Detalje vidj u uputu za montažu  
**HU** Tartsa be a bitorelemek max. megengedett terhelési értékeit. A részleteket lásd a szerelési útmutatóban  
**BG** Спазвайте макс. допустимите стойности на натоварване на мебелите. За подробности виж ръководството за монтаж  
**CZ SK** Dodržujte max. přípustné hodnoty zatížení nábytkových dílů. Podrobnosti viz návod k montáži  
**SE** Följ max. tillåten belastning av möbeldelarna. Mer information finns i monteringsanvisningen  
**RO** Respectați valorile de solicitare max. admise pentru corpurile de mobilier. Pentru detalii consultați instrucțiunile de montaj  
**ES** Respete los valores máximos de carga admisibles para las piezas de los muebles. Consulte los detalles en las instrucciones

**D CH AT LI LU** Zur Möbelfreinigung ein mit Wasser befeuchtetes, fusselfreies Baumwolltuch verwenden. Geeignigte Flächen immer trockenreiben!  
**GB US** To clean the furniture only use a water dampened lint-free cotton cloth. Once cleaned, always wipe the surfaces dry.  
**FR BE NC** Utilisez un chiffon en coton non pelucheux humidifié avec de l'eau pour nettoyer les meubles. Séchez systématiquement les surfaces  
**NL** nettooyes en les froitant!  
**IT** Gebruik een met water bevochtigde, pluïsvrije katoenen doek om de meubels te reinigen. Wrijf gereinigde oppervlakken altijd droog!  
**SI** Per pulire il mobile utilizzare un panno di cotone inumidito d'acqua e che non perde pelucchi. Asciugare sempre le superfici che si sono pulite!  
**XS HR BA** Za čišćenje pohištva uporabljajte vlažno bombažno krpo, ki ne pušča vlaken. Očiščene površine vedno obrišite do suhlega!  
**HU** Za čišćenje namještaja koristite sa vodom navlaženu pamučnu krpu koja ne ispušta vlakna. Očišćene površine uvijek obrišite suhom krpom!  
**BG** За почистване на мебелите използвайте навлажнена с вода, неизглусяща влакна памучна кърпа. Почистените повърхности винаги да се изтриват до сухо!  
**CZ SK** K čištění nábytku používejte bavlněný hadr neuvloňující vlákna, navlhčený ve vodě. Učištěné plochy vždy utřete do sucha!  
**SE** För möbelförpackning används en luddfri bomullsduk fuktad med vatten. Rengjorda ytor ska alltid torflas torra!  
**RO** Pentru curățarea mobiliei utilizați o lavetă din bumbac fără scame umezită cu apă. Suprafețele curățate se șterg întotdeauna până se usucă!  
**ES** Emplee un paño de algodón humedecido con agua y libre de pelusa para la limpieza de los muebles. ¡Seque siempre las superficies que ha limpiado!