

DE Aufbauanleitung „E-Montagepaneel“

- Ⓞ GB Assembly manual for “Electrical mounting panel”
- Ⓞ FR Notice de montage du “Support pour installation électrique”
- Ⓞ NL Opbouwbeschrijving voor “Electro-Montagepaneel”
- Ⓞ ES Instrucciones de montaje de “Cuado eléctrico”
- Ⓞ IT Istruzioni di montaggio “Pannello di montaggio elettrico”
- Ⓞ DK Monteringsvejledning for “Elkabel tilslutningspanel”





HighLine® / Panorama® / AvantGarde® / Europa / Geräteschrank

1.

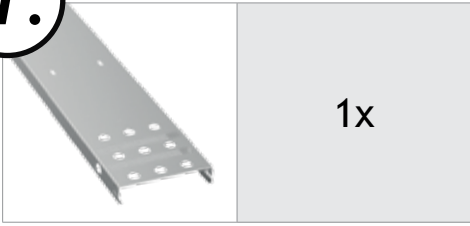

1.

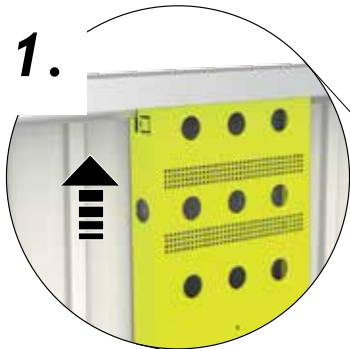

4.

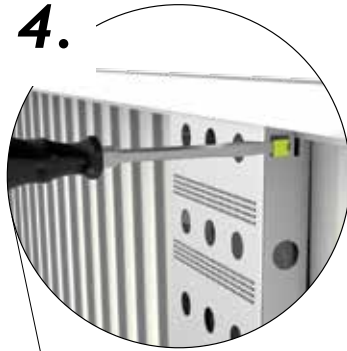

5.

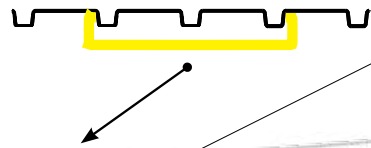
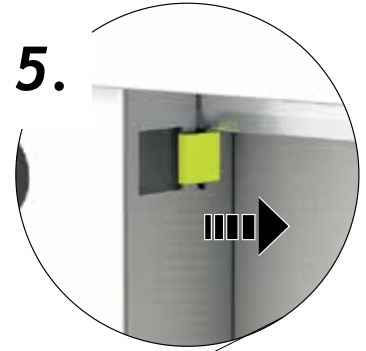

2.

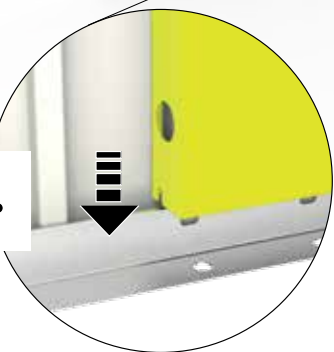

3.

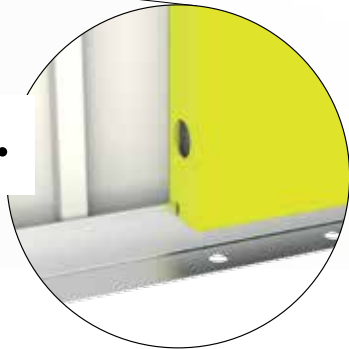



MiniGarage

1.

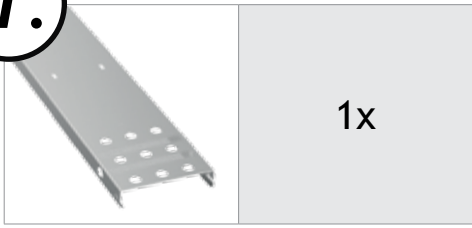

1.

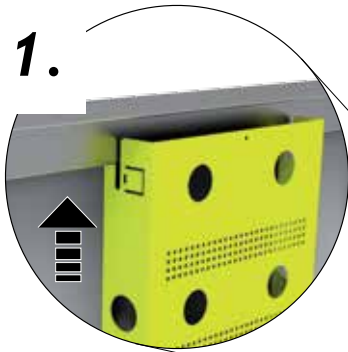

4.

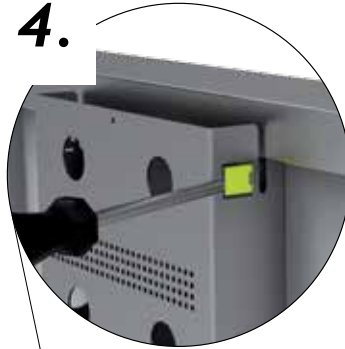

5.

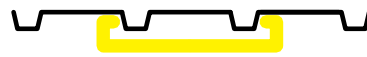
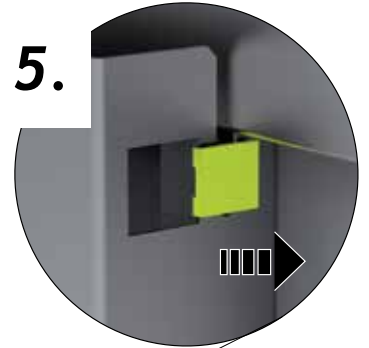

2.

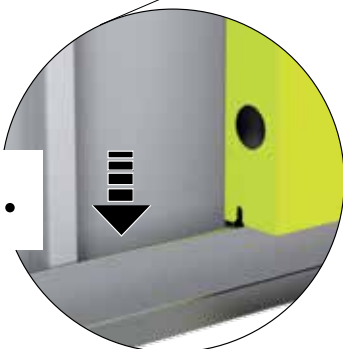

3.

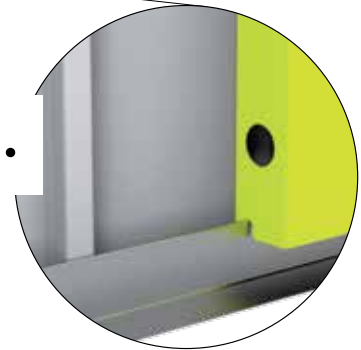



HighBoard 200

1.

	1x	4,8 x 9,5		4x
--	----	-----------	--	----

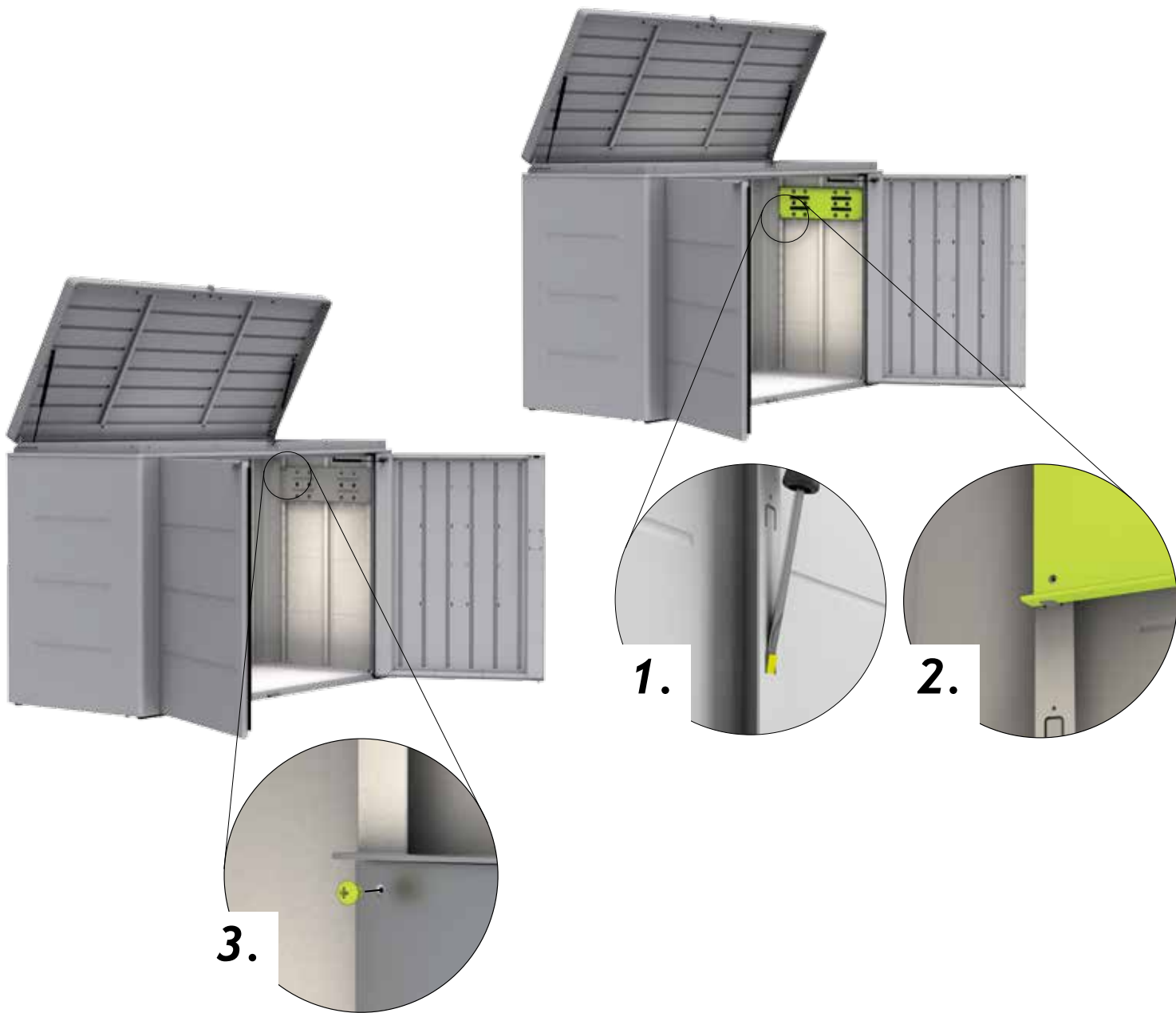

Biohort GmbH
 Pürnstern 43, 4120 Neufelden, Österreich
 Tel.: +43-7282-7788-0, Fax-DW: 190
 E-Mail: office@biohort.at, www.biohort.com

Kontrollnummer:
 Control-number / Contrôle-Qualité / Controlnummer:

Bei Reklamationen bitte anführen:
 Kontrollnummer und Artikelnummer des reklamierten Teils.

GB: In case of complaint please indicate the control-number and the number of the item, which is subject of complaint.

F: Pour toutes réclamations: prière de joindre le numéro de contrôle et le numéro d'article de la pièce litigieuse.

NL: Bij reclamaties svp doorgeven: controlnummer en artikelnummer van het desbetreffende onderdeel.

YH046030
 Version 11 / 2019