

Mod. ... / 81 TLL

PACK. 489



6 x
SCHR. 322
M4 x 8 mm



6 x
SCHR. 310
M4 x 16 mm



10 x
SCHR. 342
3,5 x 15 mm



104 x
SCHR. 325
6,3 x 10,5 mm



6 x
BESC. 423
8 mm

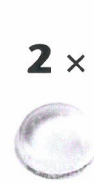

2 x
BESC. 645



2 x Q

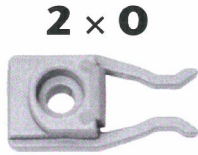

2 x O

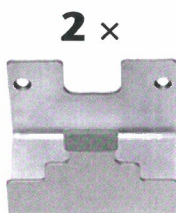

2 x
12442

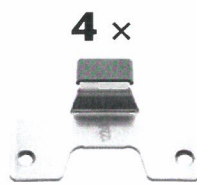

4 x
1226
BESC. 580/8



1 x
8 cm
TEIL. 364



1 x T



2 x

2 x S



1 x N

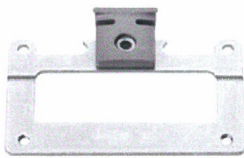

1 x

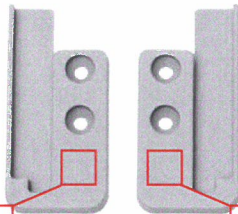

L

R

2 x

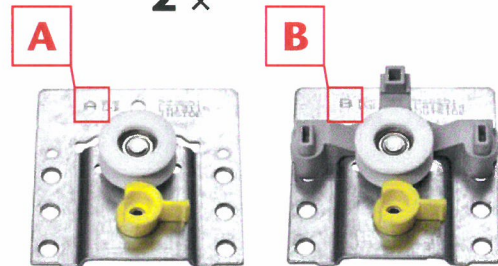

A

B

2 x U



2 x P

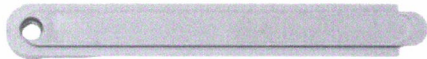

1 x F1



1 x F2



1 x G1



1 x G2

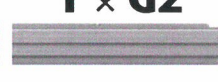

4 x I



2 x J



6 x M



4 x H



M: 1:1

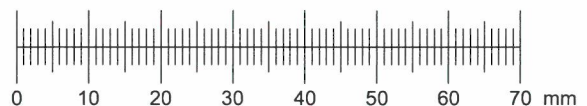

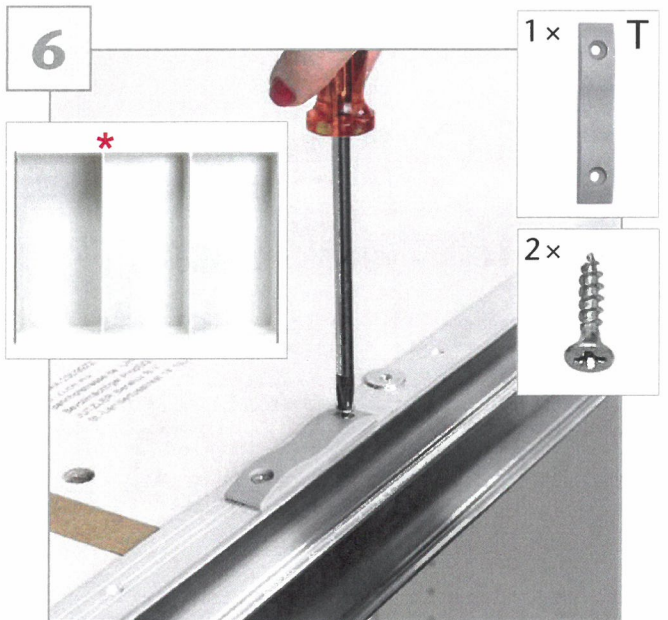
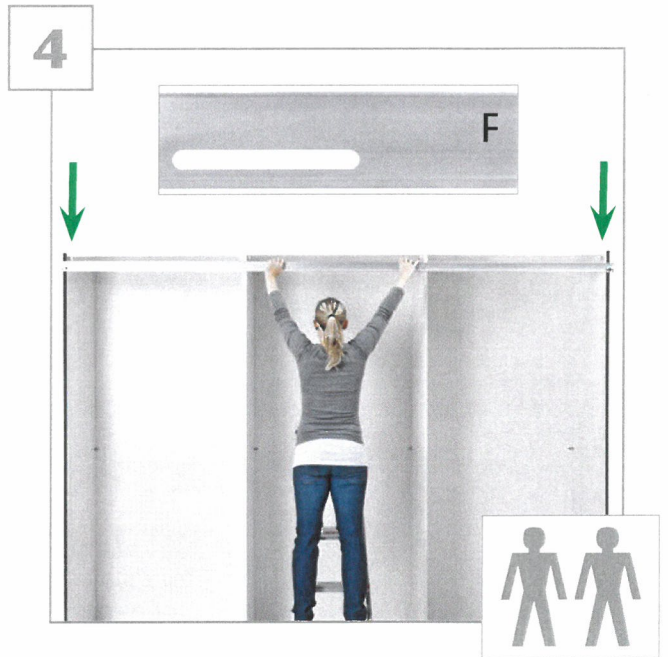
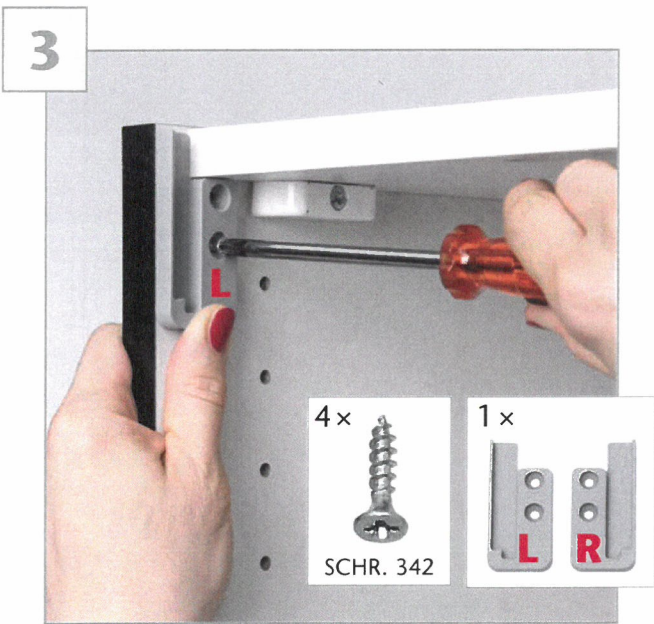
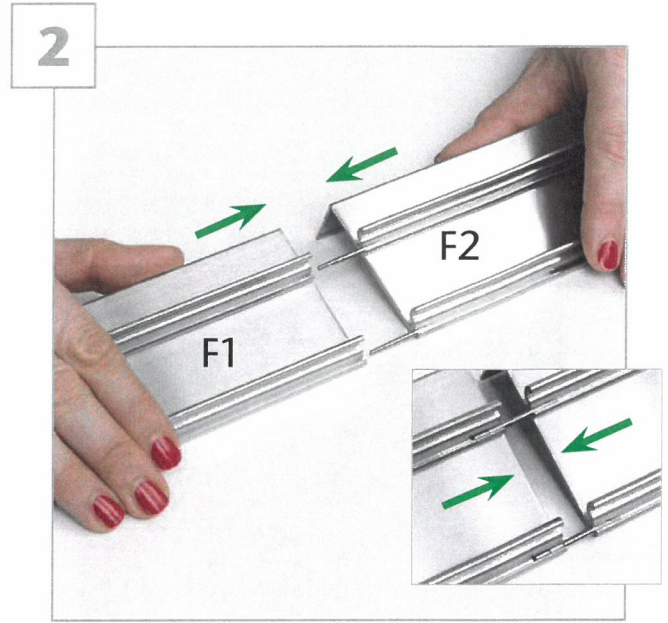
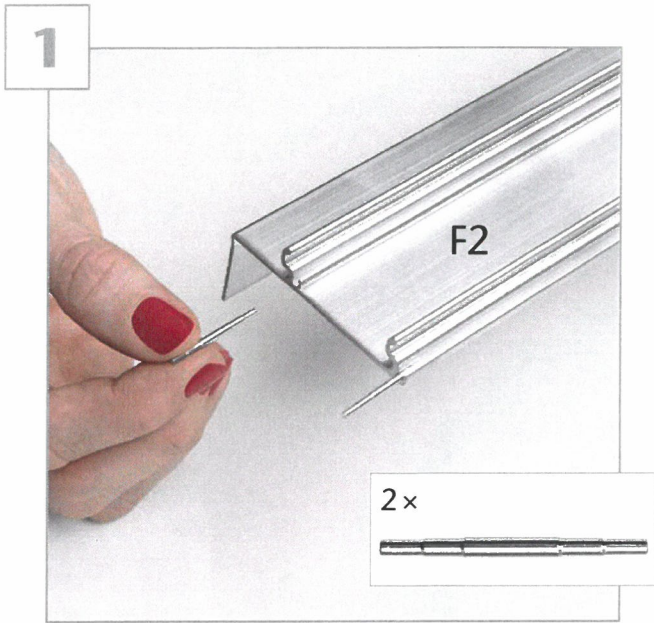

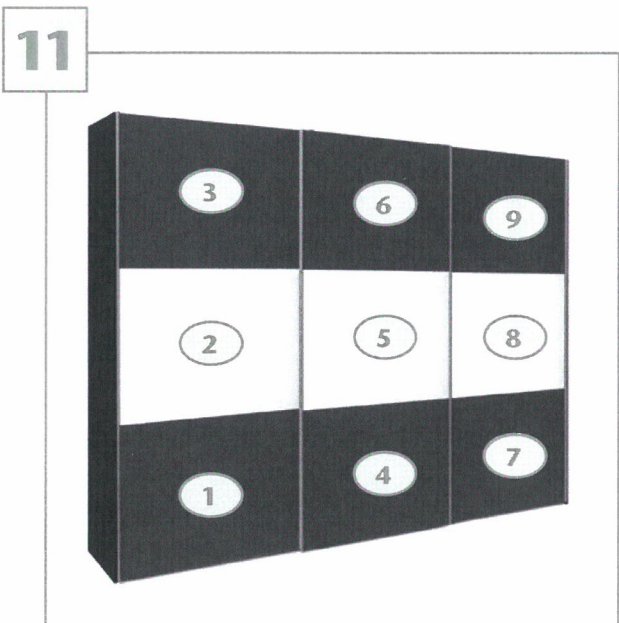
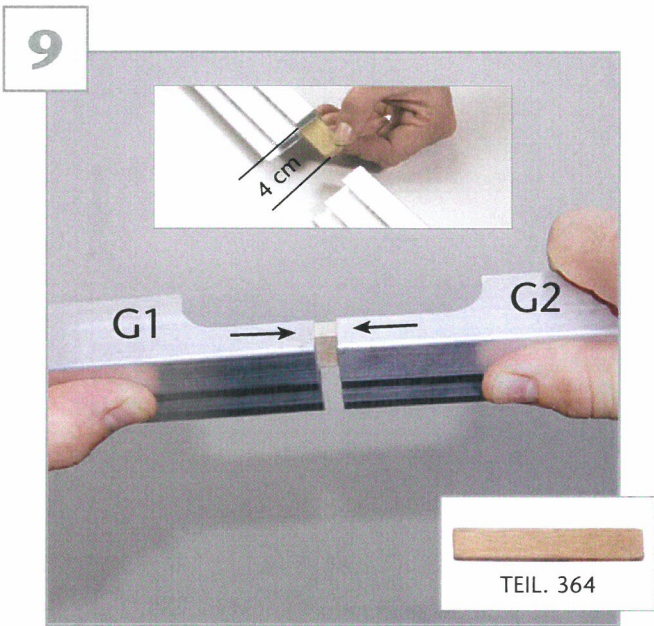
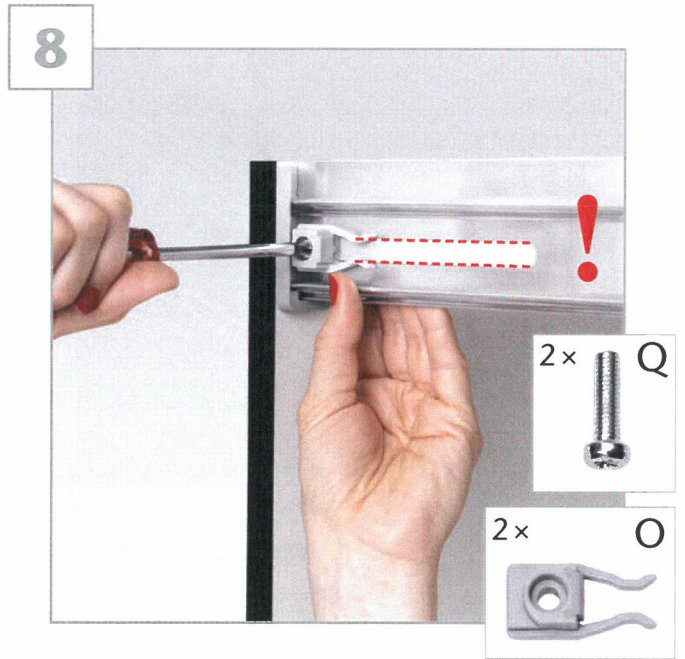
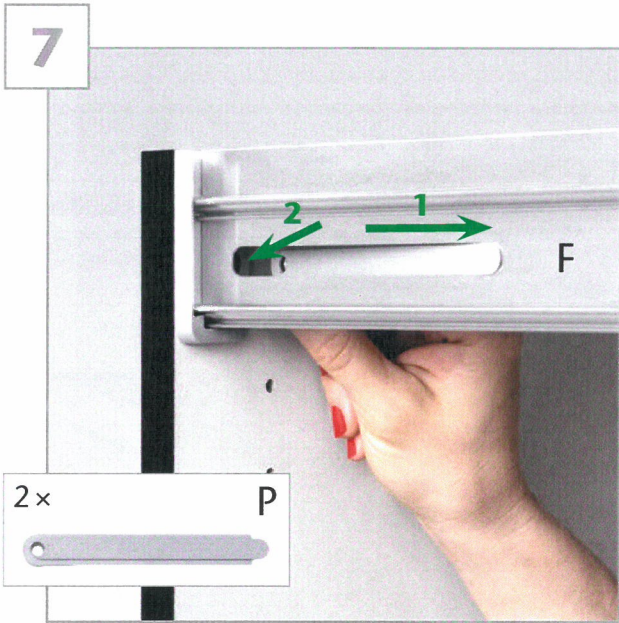

13

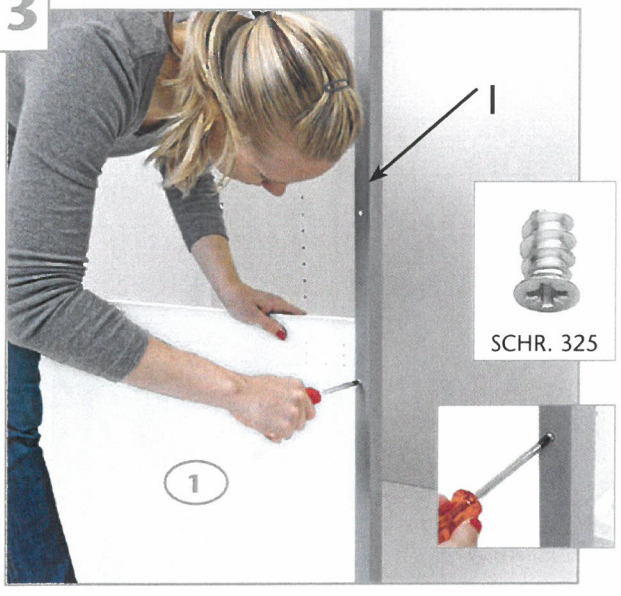

14

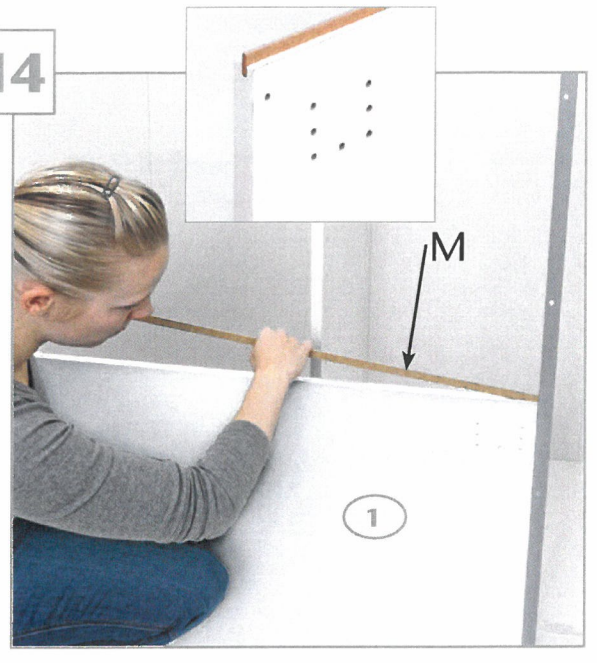

15

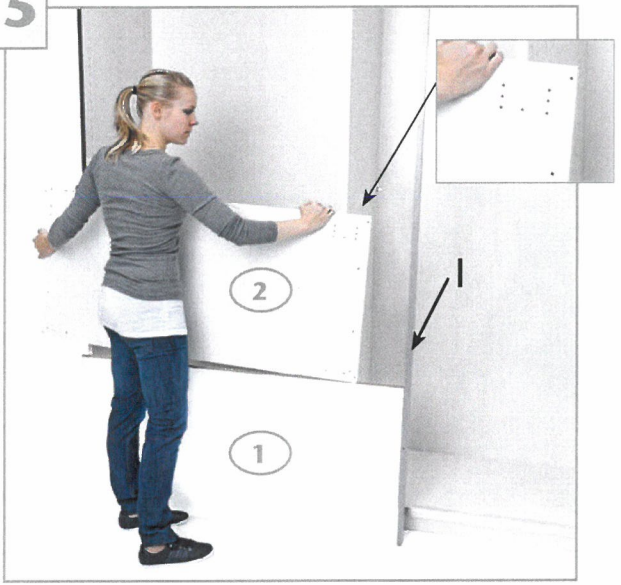

16



17

