

60min

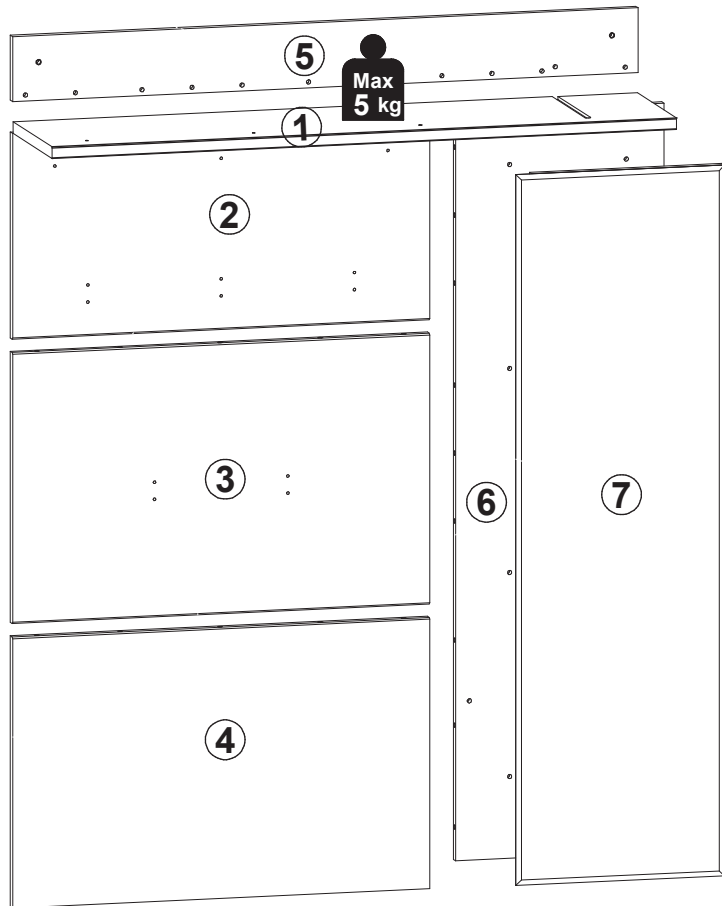

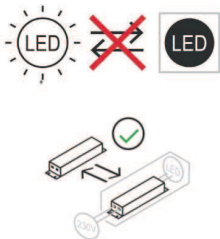

A	B	C1	C2	C3	D
1	M231-3005	1199	280	22	1/2
2	M231-4001	388	801	16	2/2
3	M231-4002	510	801	16	2/2
4	M231-4003	510	801	16	2/2
5	M231-4004	122	1201	16	1/2
6	M231-4005	1408	400	16	1/2
7	M231-4501	1338	400	20	1/2

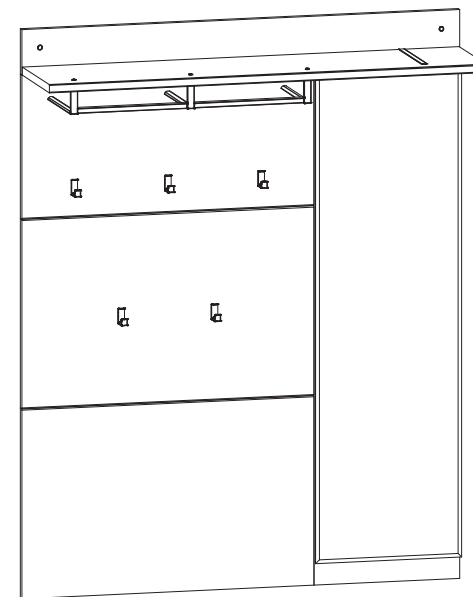

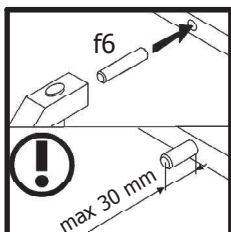
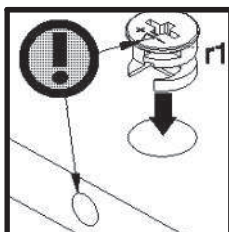
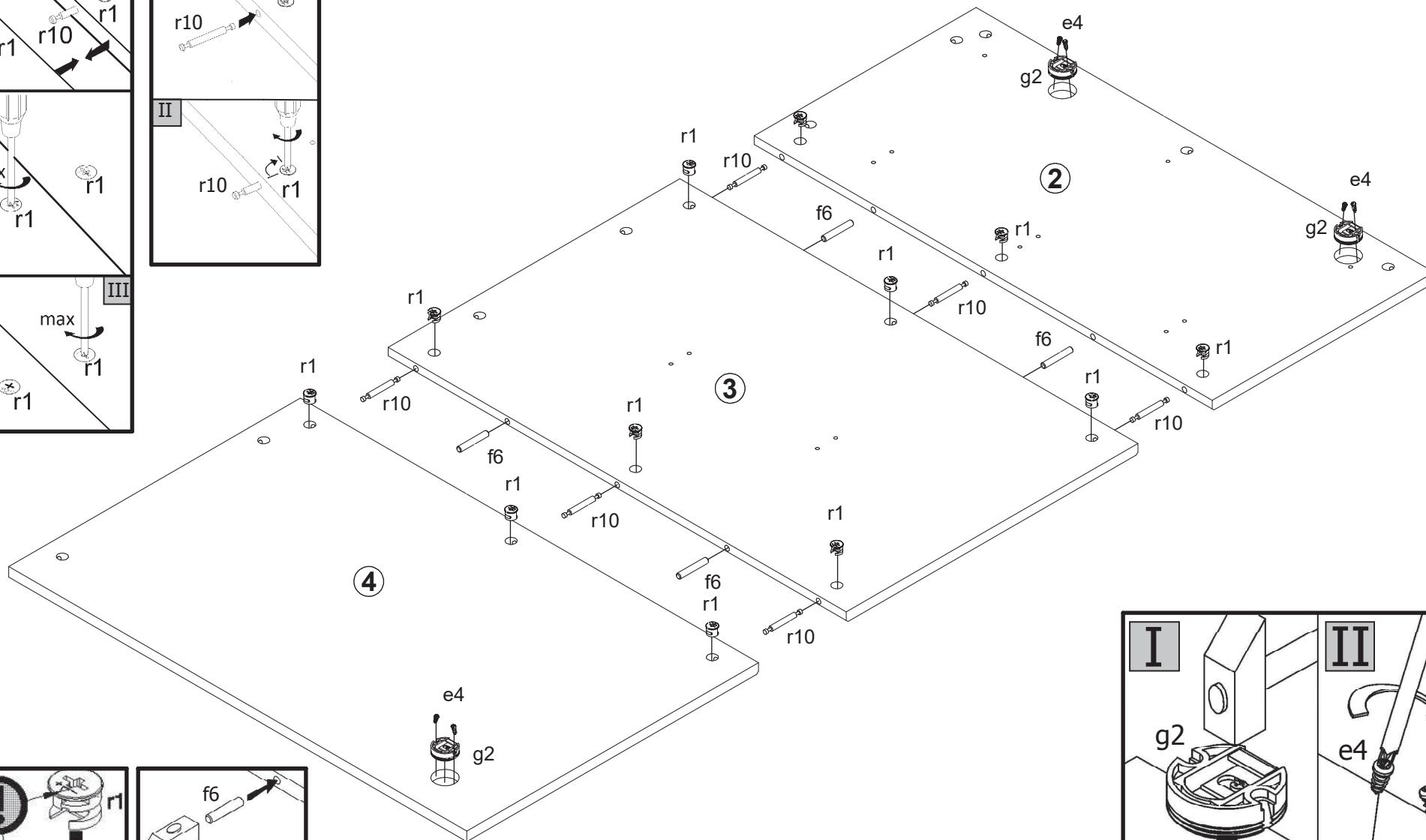
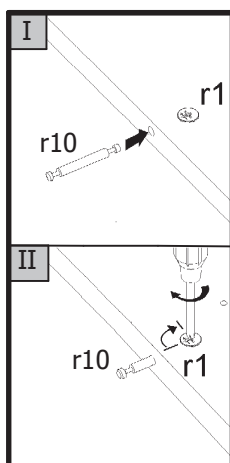
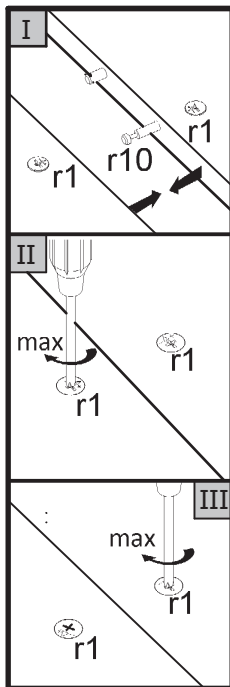



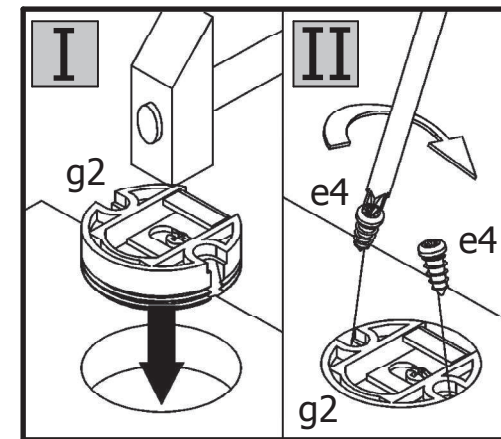

6x Ø7x60 mm e8	8x Ø7x28 mm e22	8x Ø5x11 mm e4	5x Ø8x30 mm f1	10x Ø8x50 mm f6	6x Ø10x50 mm f35	4x g2	5x g73	1x g74\1L	1x g74\1P	1x g74\2	2x g74\3	4x g74\4
13x M4x22 mm j30	3x M4x28 mm j11	4x Ø6x60 mm p75	32x Ø15x12 mm #16 r1	16x r10	1x z1	1x 233mm w116\5	1x 710x13x8 o121\1	1x o72\1	2x Ø5x60 mm p76	2x Ø12x0.5 mm s59	1x o80\3	1x 12W o80\11

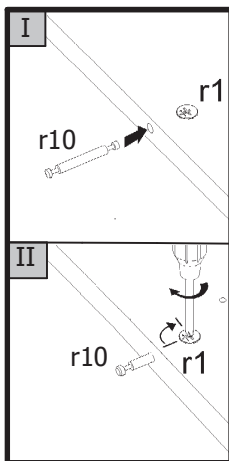
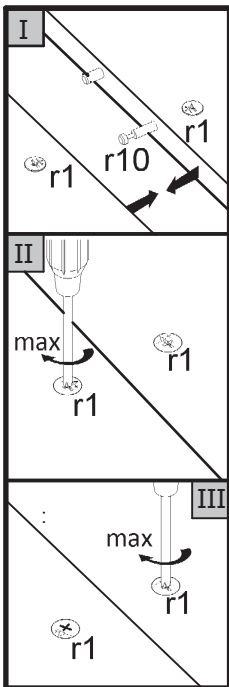

- 3x  g2
- 6x  e4  
Ø5x11 mm
- 12x  r1  
Ø15x12 mm #16
- 6x  r10
- 4x  f6  
Ø8x50 mm





- 1x  g2
- 2x  e4  
Ø5x11 mm
- 12x  r1  
Ø15x12 mm #16
- 6x  r10
- 3x  f6  
Ø8x50 mm

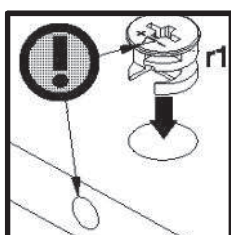
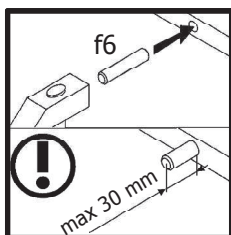
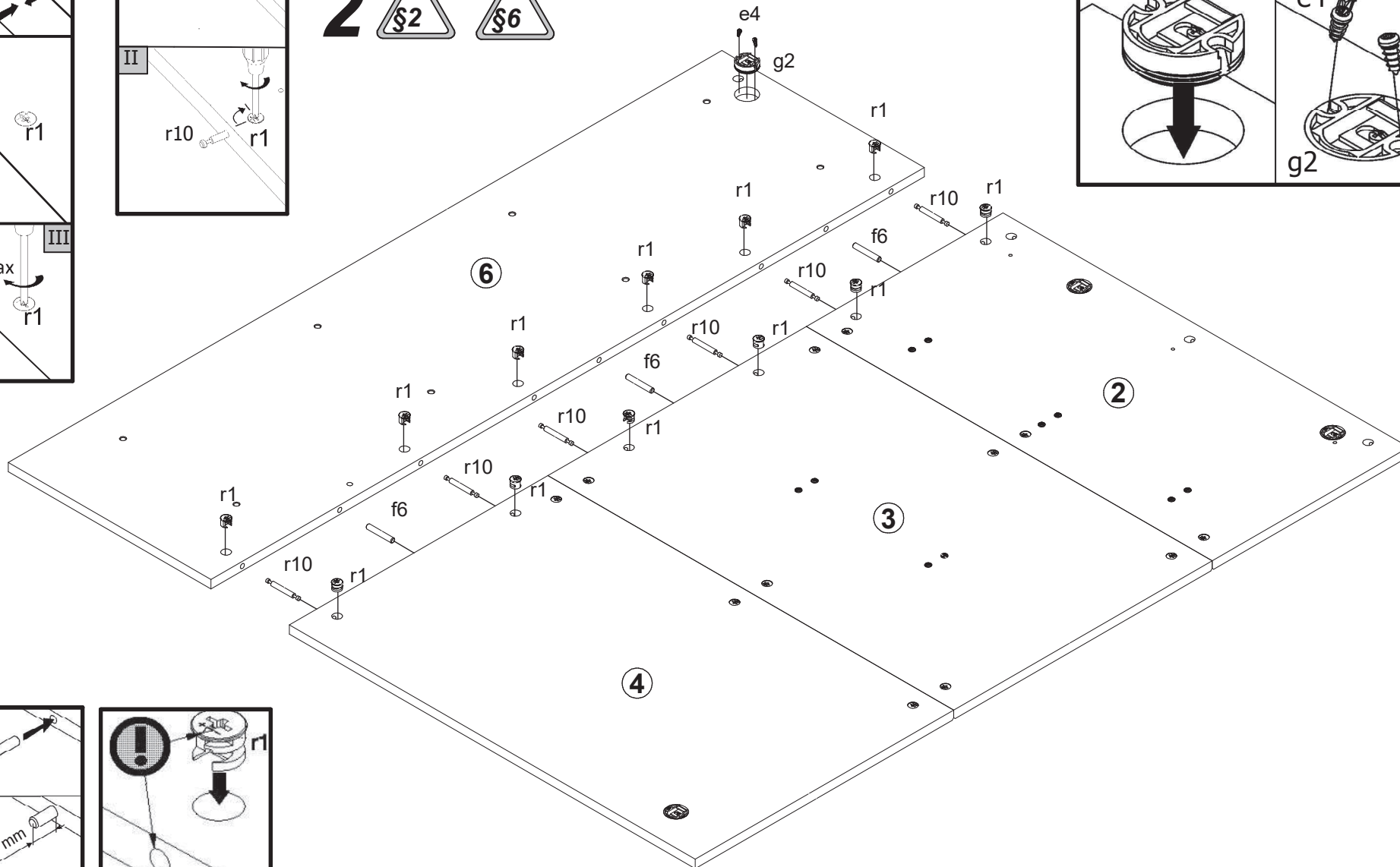
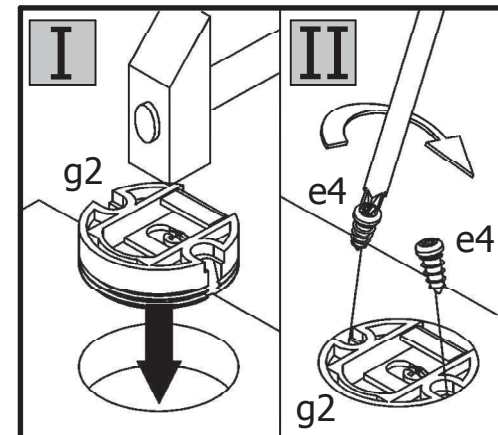

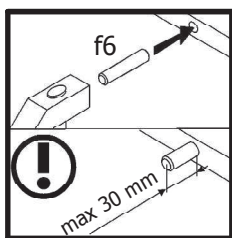
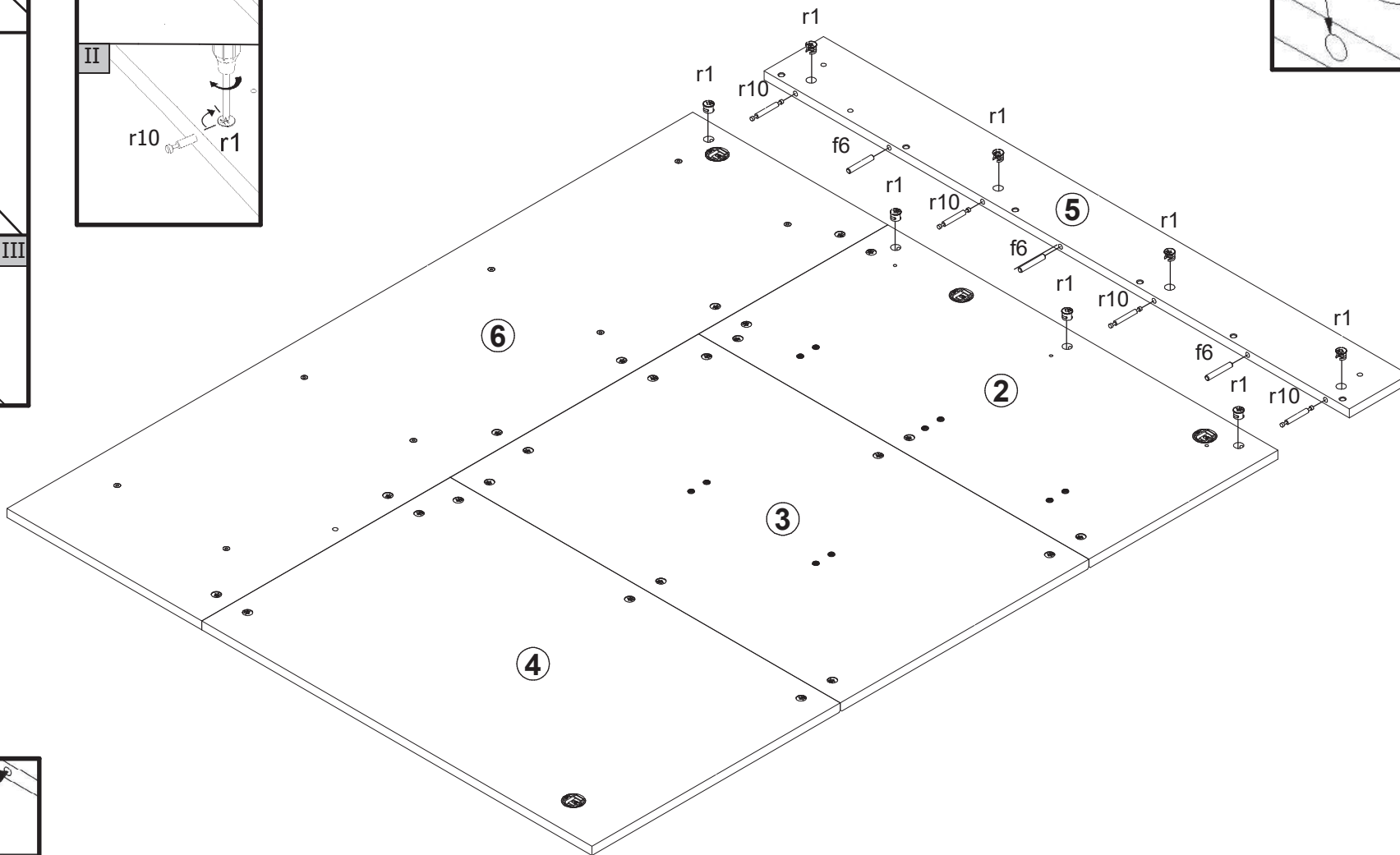
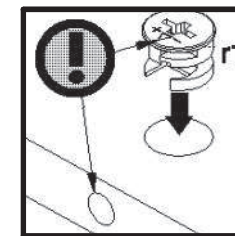
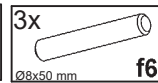
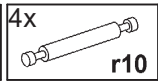
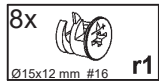
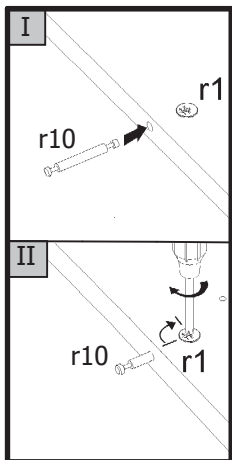
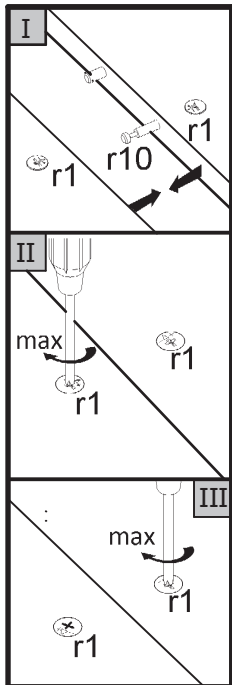

4

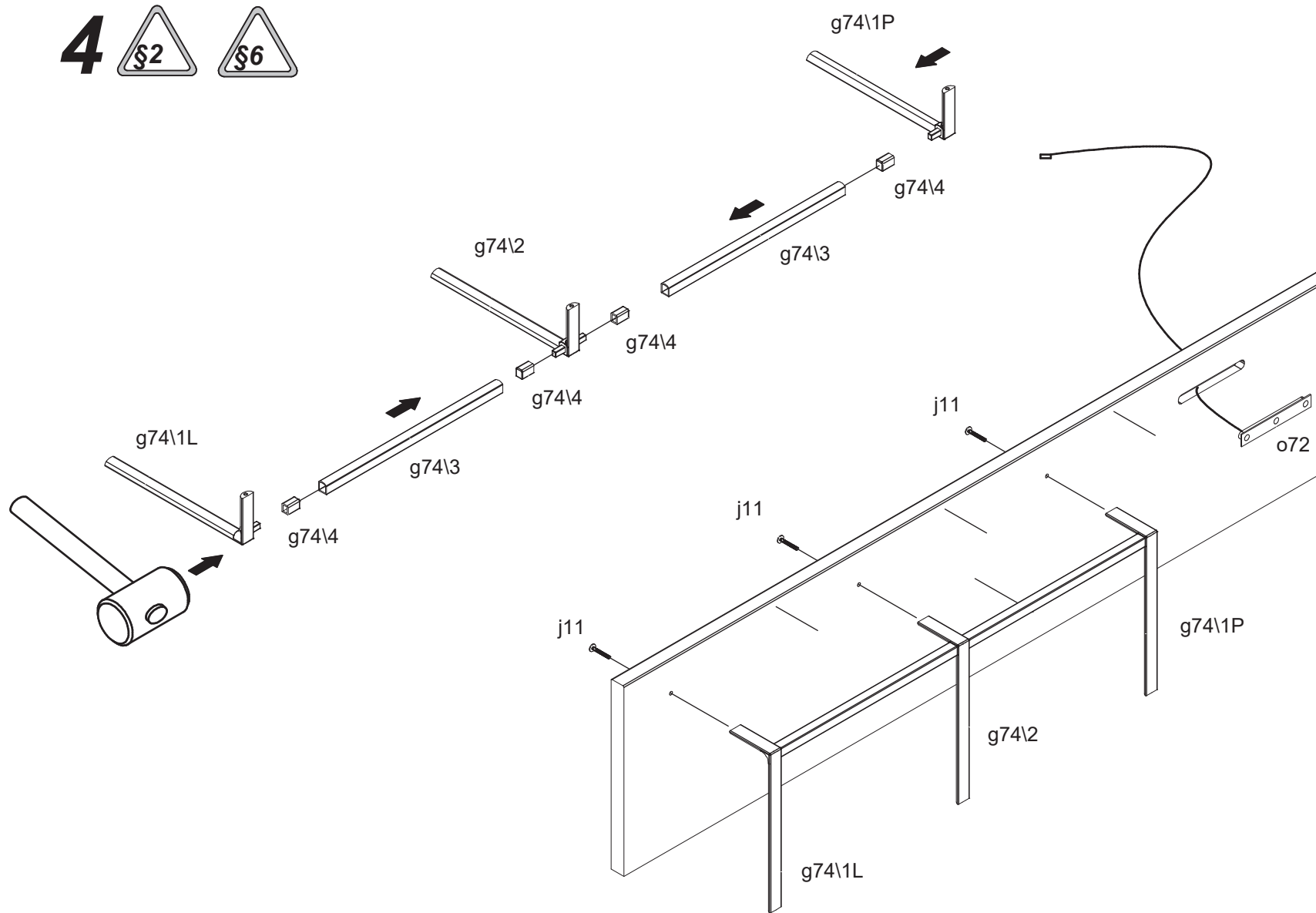

5

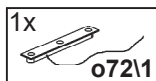
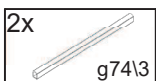
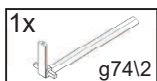
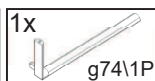
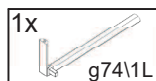

6

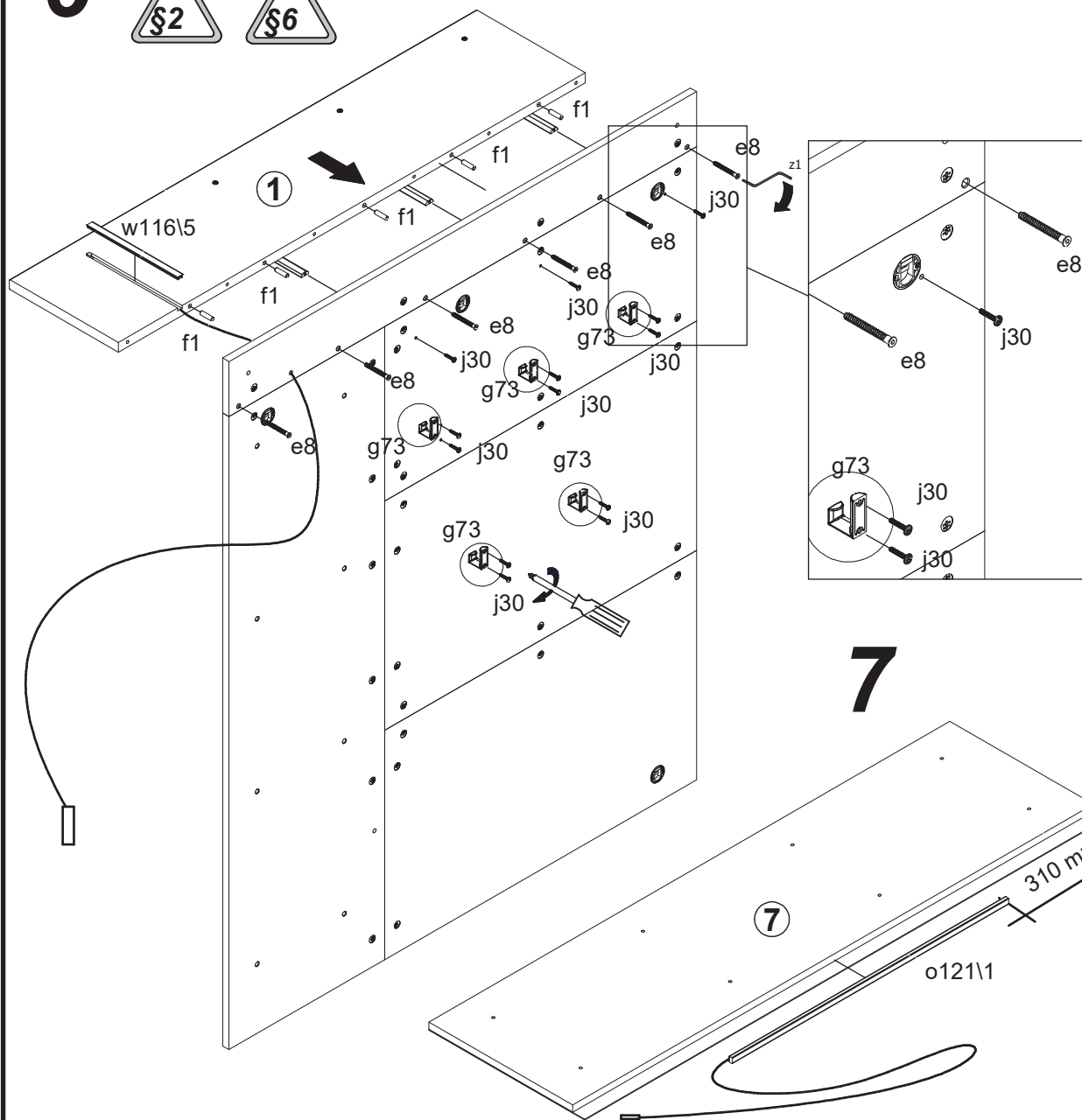

8

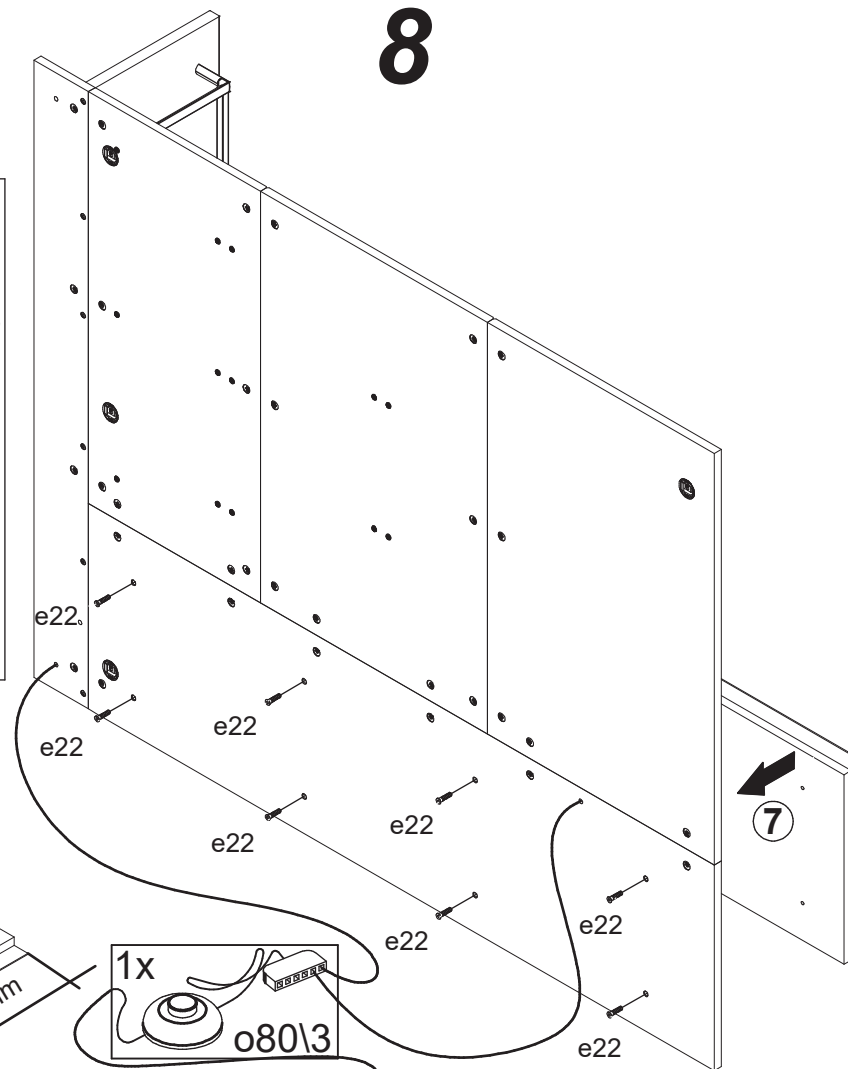

7

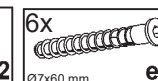
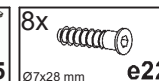
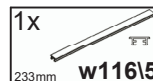
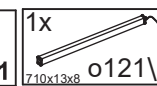
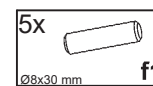
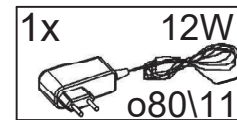
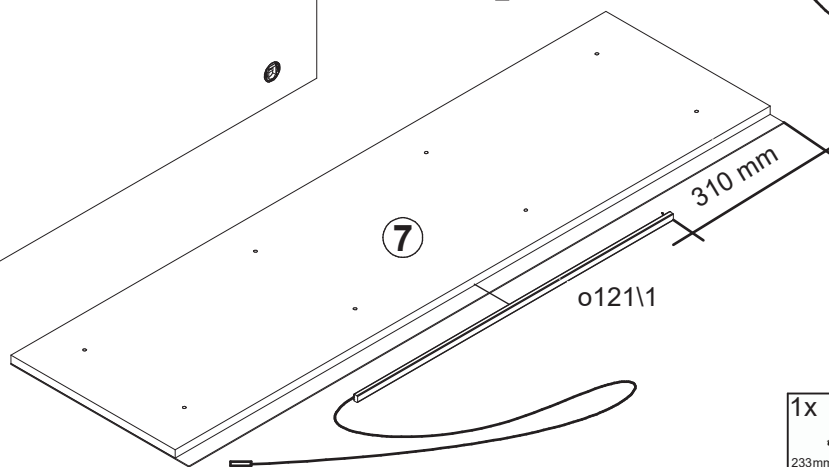



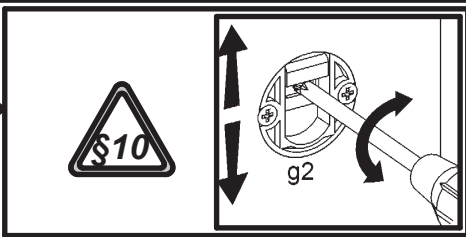
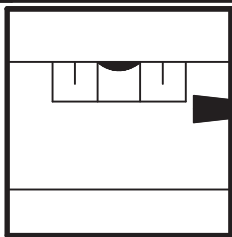

9

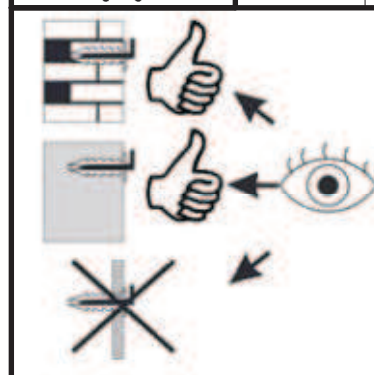
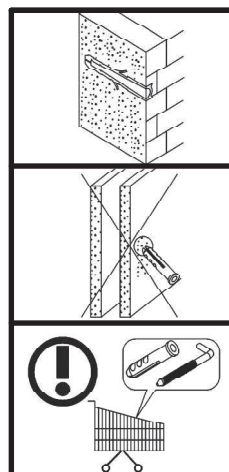
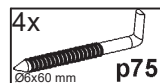
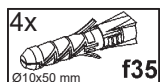
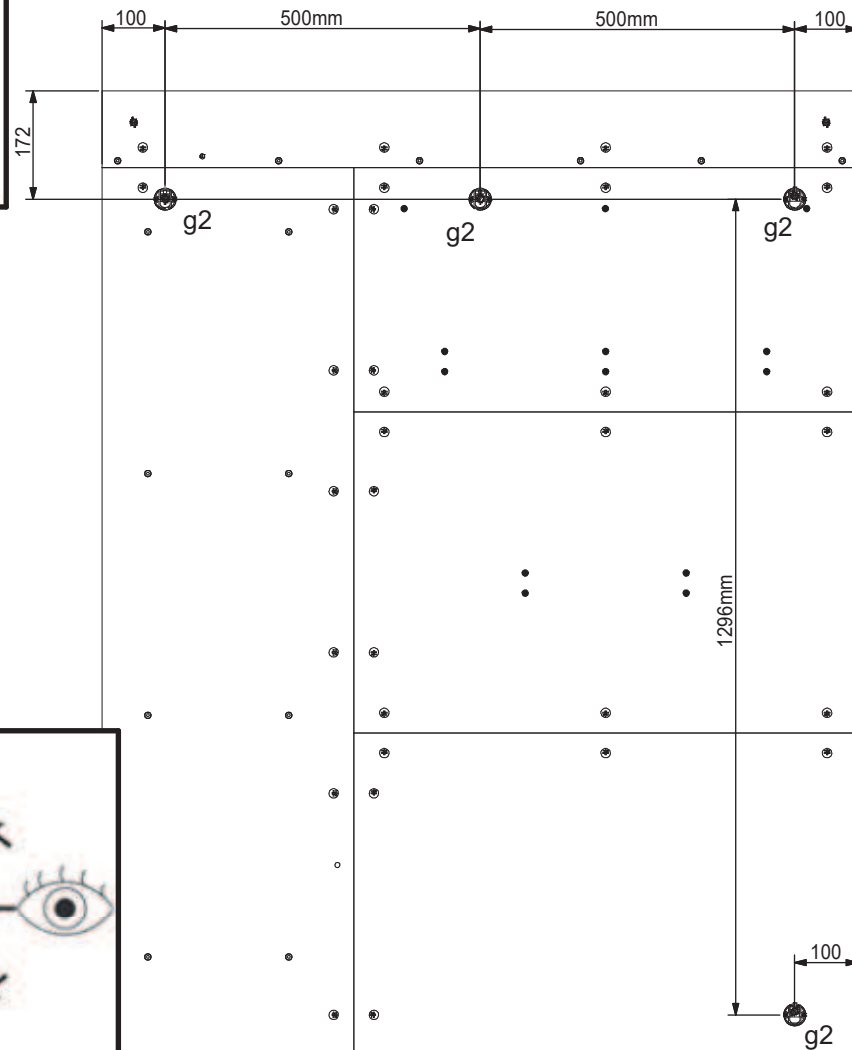
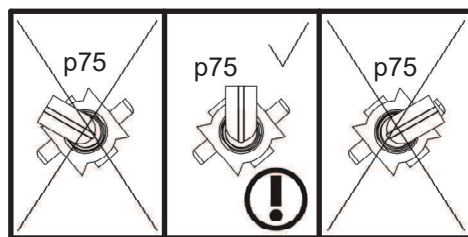
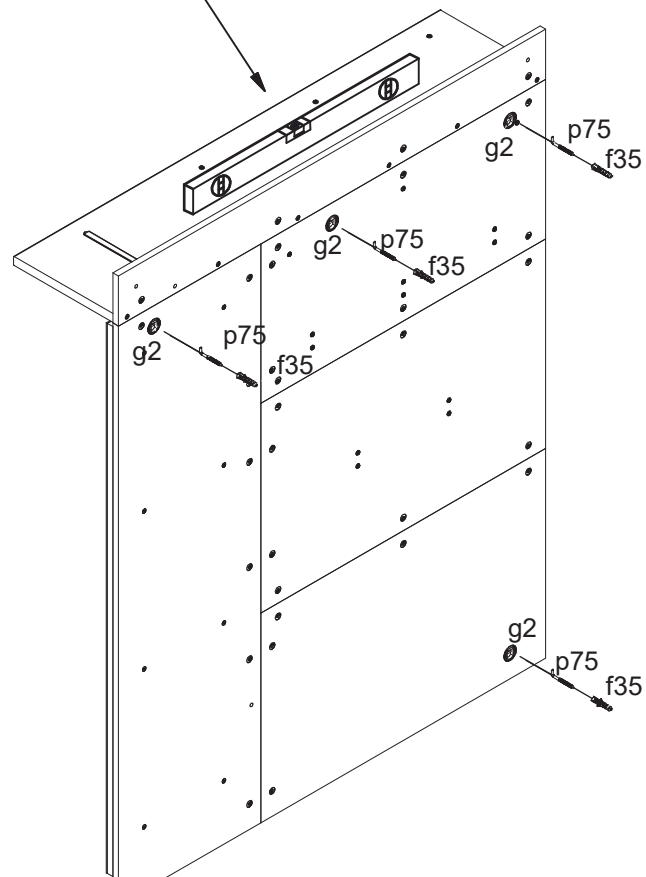
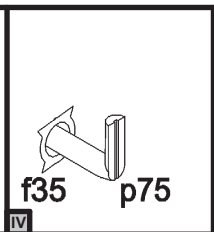
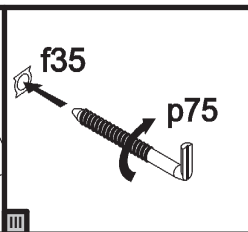
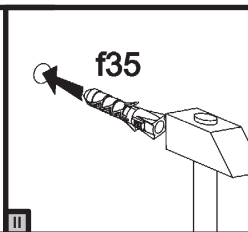
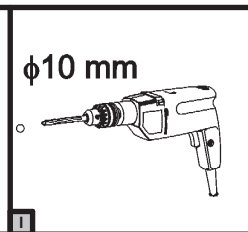



# 10

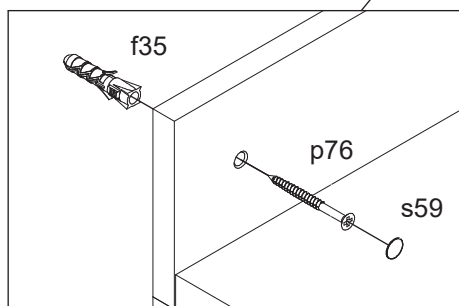
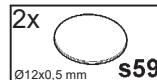
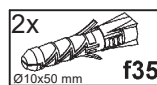
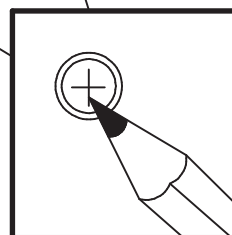
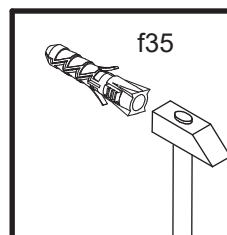
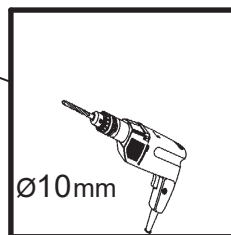
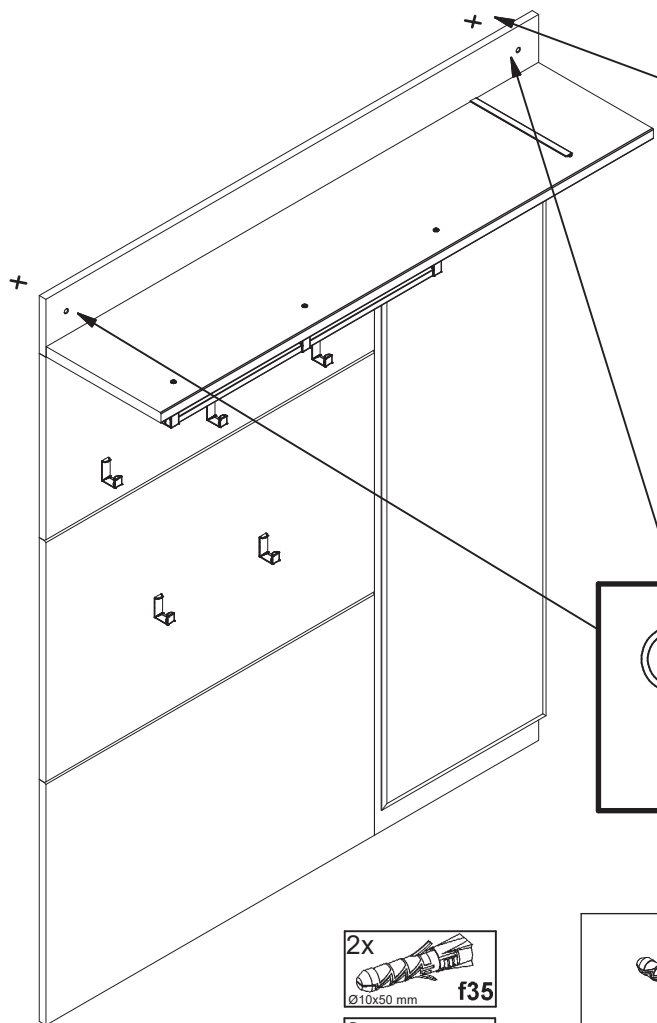

# 11

