

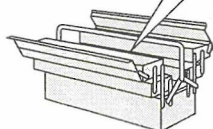

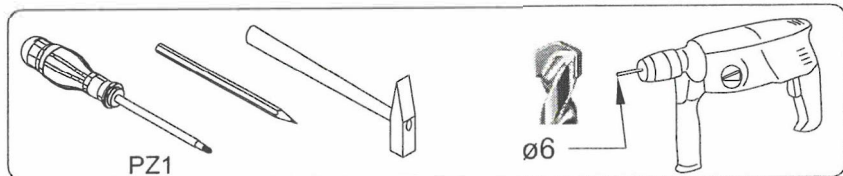

- | | |
|---|---|
| (D) Montageanleitung »Granada I« | (GB) Assembly instructions »Granada I« |
| (FR) Notice de montage »Granada I« | (IT) Istruzioni di montaggio »Granada I« |
| (NL) Handleiding voor de montage »Granada I« | (PL) Instrukcja montażu »Granada I« |
| (CZ) Montážní návod »Granada I« | (SK) Návod na montáž »Granada I« |
| (HU) Szerelési útmutató »Granada I« | (RO) Instrucțiuni de montaj »Granada I« |
| (TR) Montaj talimati »Granada I« | (RU) Инструкция по монтажу »Granada I« |

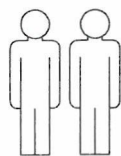





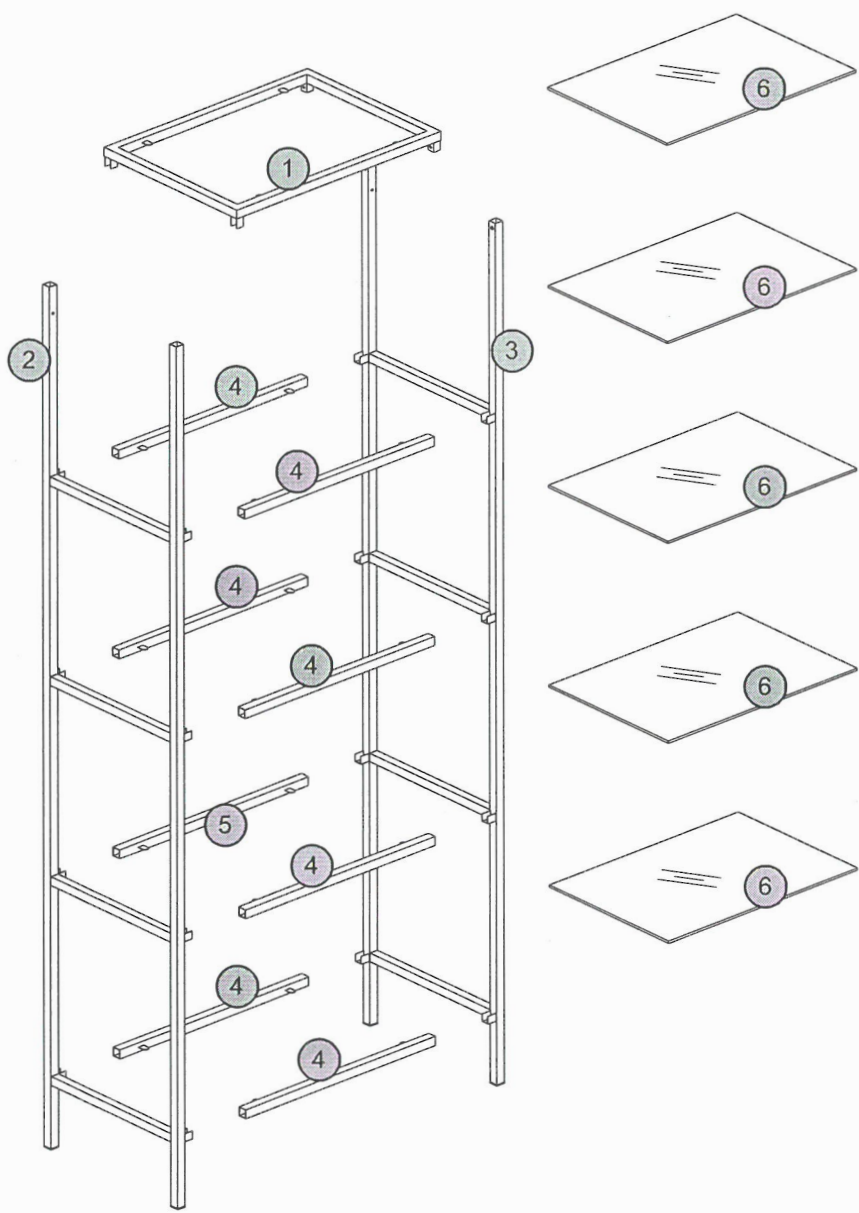
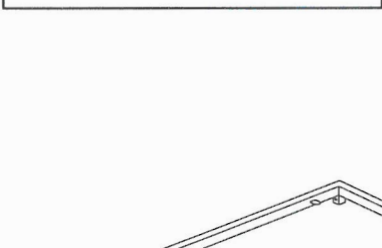
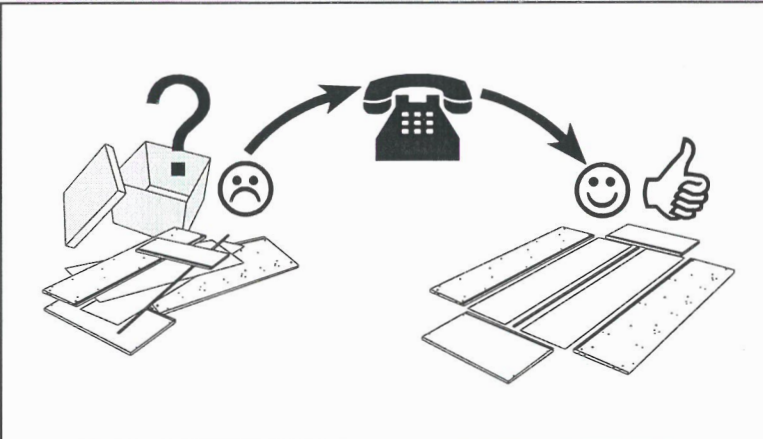

**Service · Assistenza · Dienstverlening · Serwis
Servis · Szerviz · Сервисная служба**

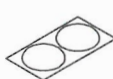
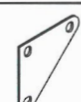
| | |
|---|-----------|
| Name · Nom · Nome · Naam Nazwa · Jméno · Názov · Név Denumire · Ísim · Название | Granada I |
| Nr. · No. · N° · Номер · Č · Sz | - |
| Tur · Type · Tír · Típus · Tipo Тип | - |
|  | - |
|  | - |
|  | - |

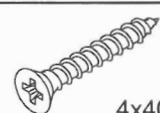

- 26x
A  M5x8
- 20x
B 
- 2x
C 
- 2x
D  6x30
- 2x
E  4x40
- 1x 

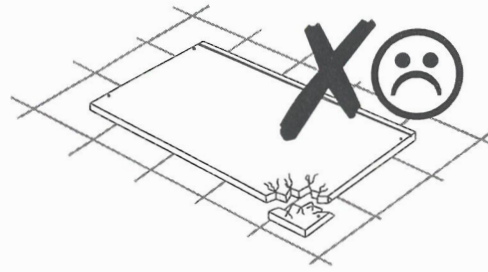
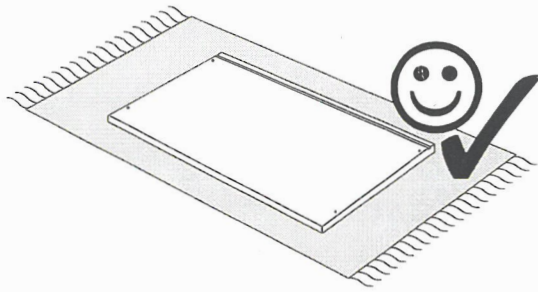

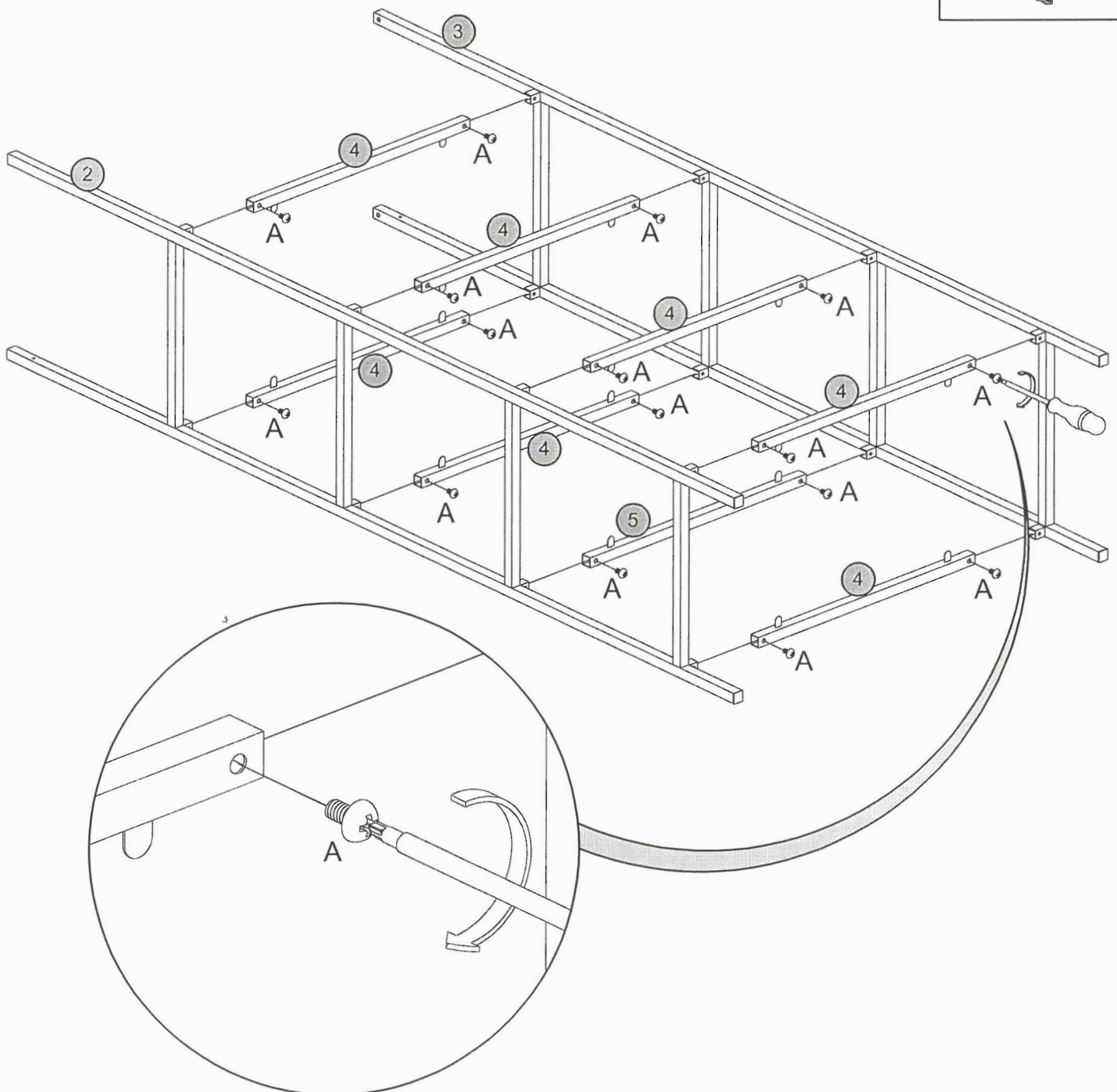
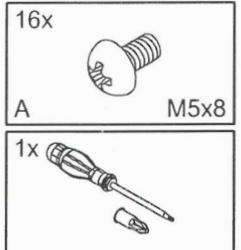

1

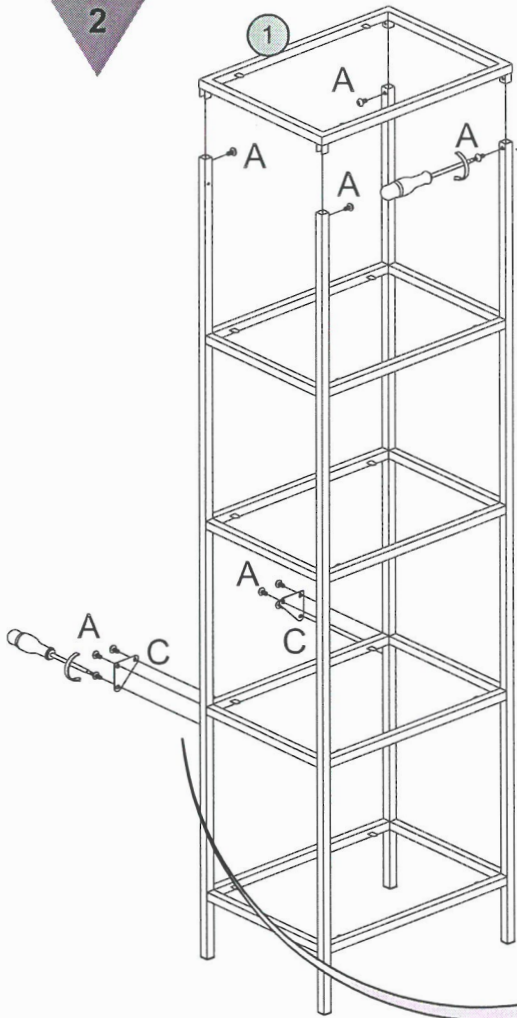

2

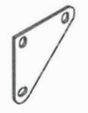

- 4x  M5x8
- A
- 2x  C
- 1x 

3

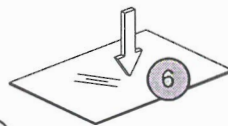
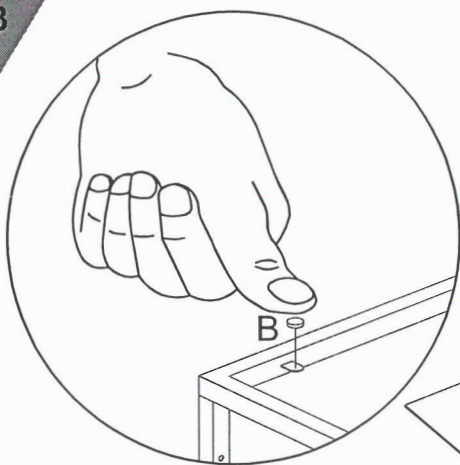

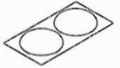
- 20x  B

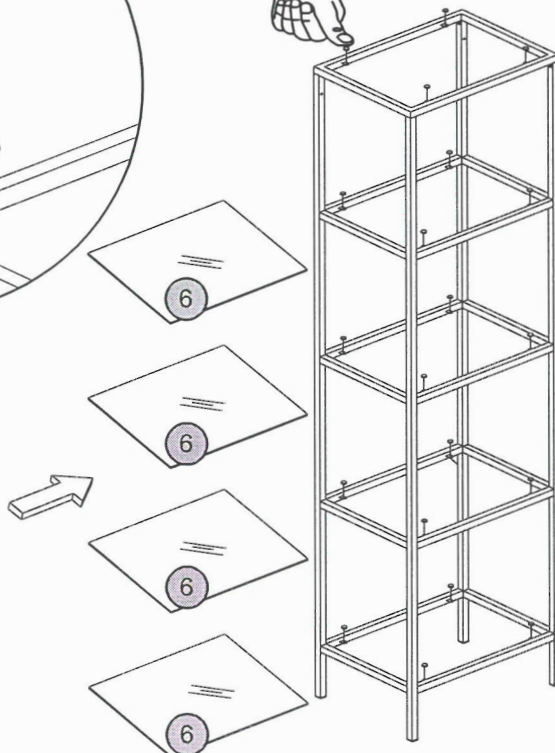



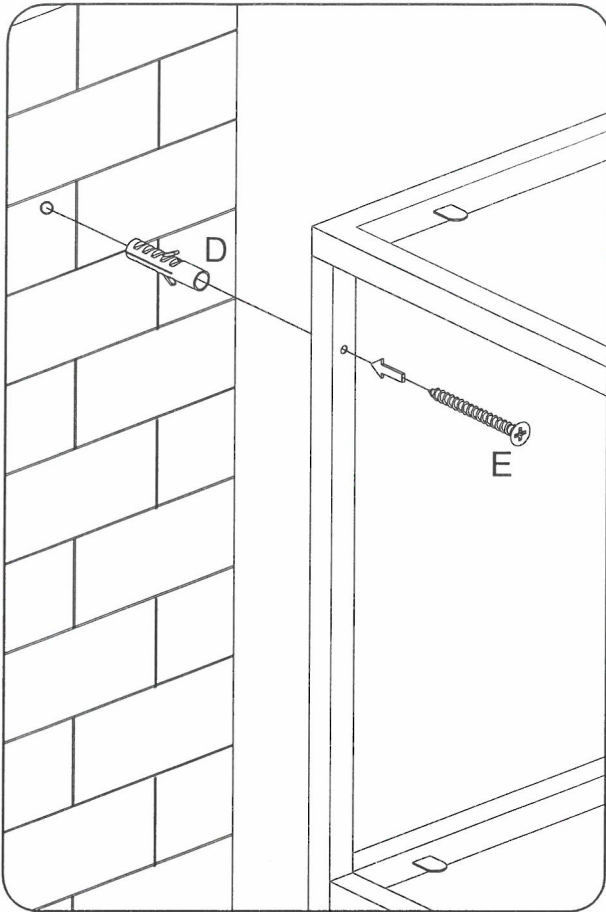

4

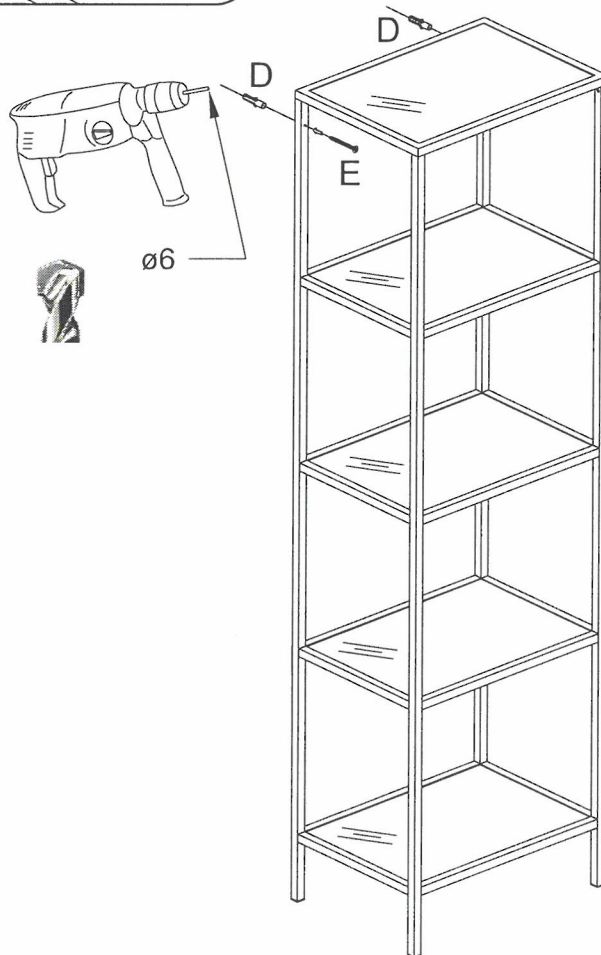

| Achtung • Attention • Attenzione Opgelet • Uwaga • Pozor • Figyelem Atenție • Dikkat • Внимание | |
|---|---|
| (D) | Wandbefestigung dient als Kippschutz – unbedingt anbringen! Bei einigen Wandtypen kann ein Spezialdübel erforderlich sein! |
| (GB) | The wall fastening serves to prevent tipping – be absolutely sure to mount it! For certain wall types, a special wall plug may be necessary! |
| (FR) | La fixation murale sert de protection contre le basculement – à installer impérativement ! Pour certains types de murs il faut des chevilles spéciales! |
| (IT) | Il fissaggio alla parete serve da protezione anti-ribaltamento – attaccarla assolutamente! Per alcune strutture di parete può essere necessario un tassello speciale! |
| (NL) | Bevestiging aan de muur dient als kantelbescherming – zeker en vast bevestigen! Bij enkele muurtypes is een speciale plug misschien vereist! |
| (PL) | Mocowanie do ściany jest jednocześnie zabezpieczeniem przed przewróceniem – koniecznie zamontować! Do niektórych rodzajów ścian koniecznie zastosować specjalne kołki mocujące. |
| (CZ) | Montáž na stěnu slouží jako ochrana proti převrnutí – bezpodmínečně umístěte! U některých typů stěn může být zapotřebí speciální hmoždinka! |
| (SK) | Upevnenie na stenu slúži ako ochrana proti prevráteniu – bezpodmienečne použite! Pre niektoré druhy stien môže byť potrebná špeciálna hmoždinka! |
| (HU) | A terméket a falhoz kel rögzíteni, kűlönben az felborulhat! Egyes faltípusoknál speciális tiplit kell használni! |
| (RO) | Sistemul de fixare la perete servește ca protecție la răsturnare – de montat obligatoriu! Pentru unele tipuri de pereți este posibil să fie necesar un diblu special! |
| (TR) | Duvardaki sabitleme, devrilmeye karşı bir emniyet tedbiridir ve mutlaka monte edilmelidir! Bazı duvar tiplerinde bunun için özel bir dübel gerekli olabilir! |
| (RU) | Обязательно установите крепление на стене во избежание опрокидывания! Для некоторых типов стен может потребоваться специальный дюбель! |

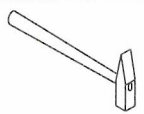

| | | |
|----|---|------|
| 2x |  | 6x30 |
| 2x |  | 4x40 |
| 1x |  | |
| 1x |  | |
| 1x |  | |