

980721

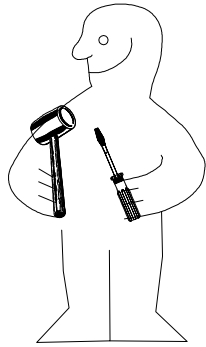

1.



2.

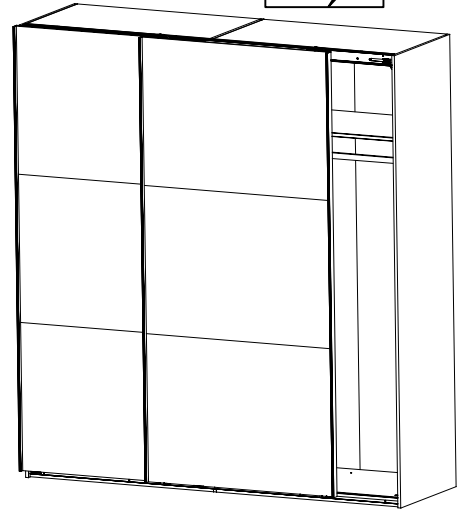
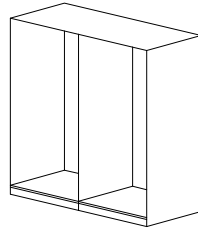



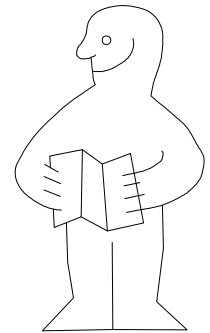
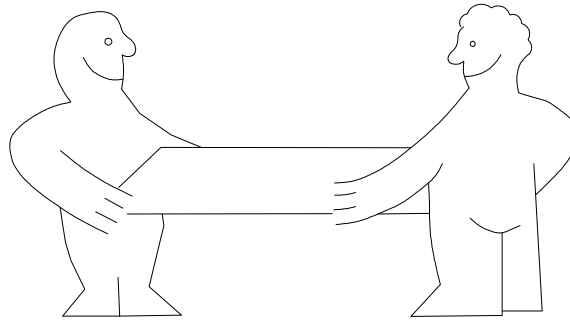
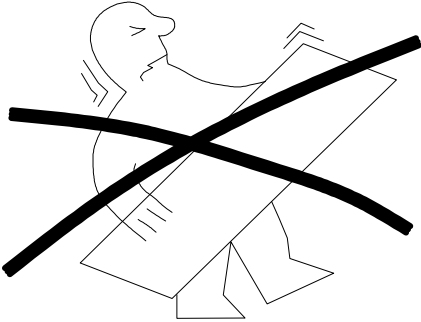

HSP 200

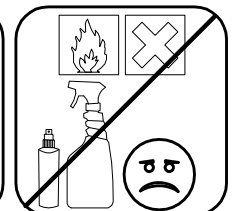
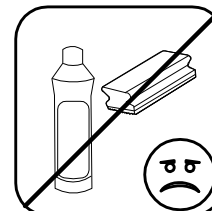
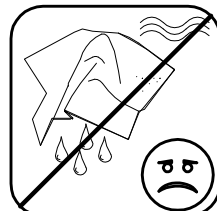
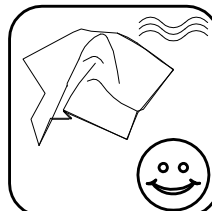
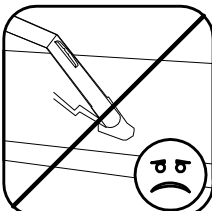
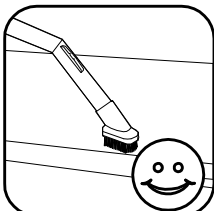
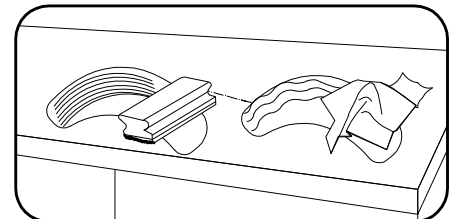
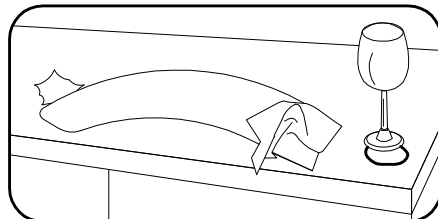
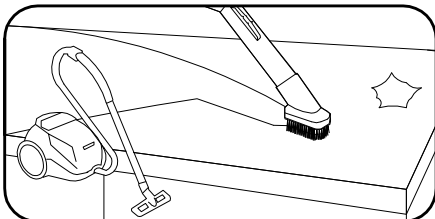
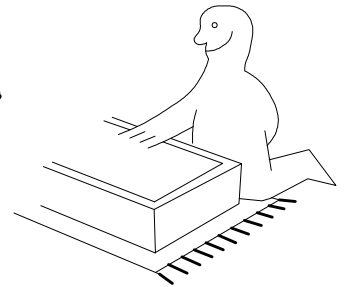
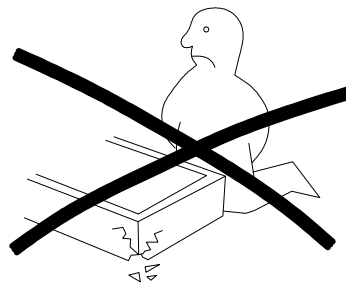
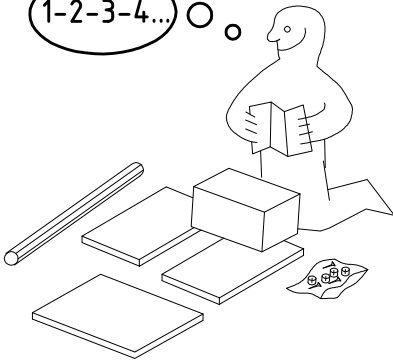

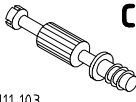



1-2-3-4... ○



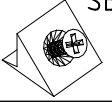

 111 xxx	A1 16x
 111 103	C 8x
	F3 4x

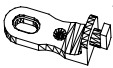
 111 xxx	S0 10x
 111 xxx ø12	V12 10x
 121 370 3,5 x 15 mm	G1 28x



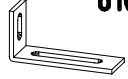

 117 002	K2 4x
 100cm	SBV 16x
 112 400	K10 2x

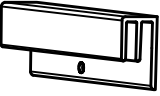

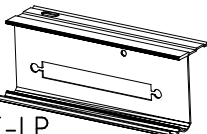
 111 611	J2 6x
 112 055 6,3 x 10,5 mm	T1 24x
 111 607	L8 8x

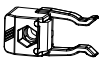
 111 052	o10 1x
 121 120 4 X 15mm	SP15 3x

1x 
FPK
1453/1940/2430/2920/3408

1x 
SWT-LP
1453/1940/2430/2920
/3410 SY

 121 xxx	SWT-ST 2x
 121 xxx M4 x 13 mm	SWT-SM5 2x
 121 xxx M4 x 10 mm	GH13 4x
 121 xxx M4 x 10 mm	G43 4x
 121 xxx 3,5 x 35 mm	G14 2x

 121 004	SWH-SKL 1x
 121 004 3,5 x 22 mm	SWH-SKR 1x
	G24 7x

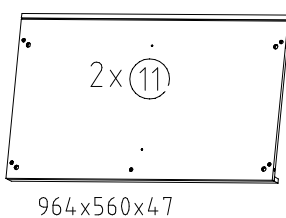
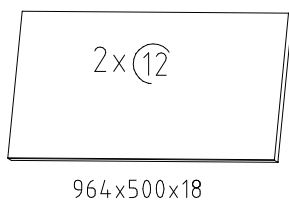
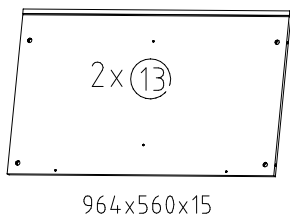
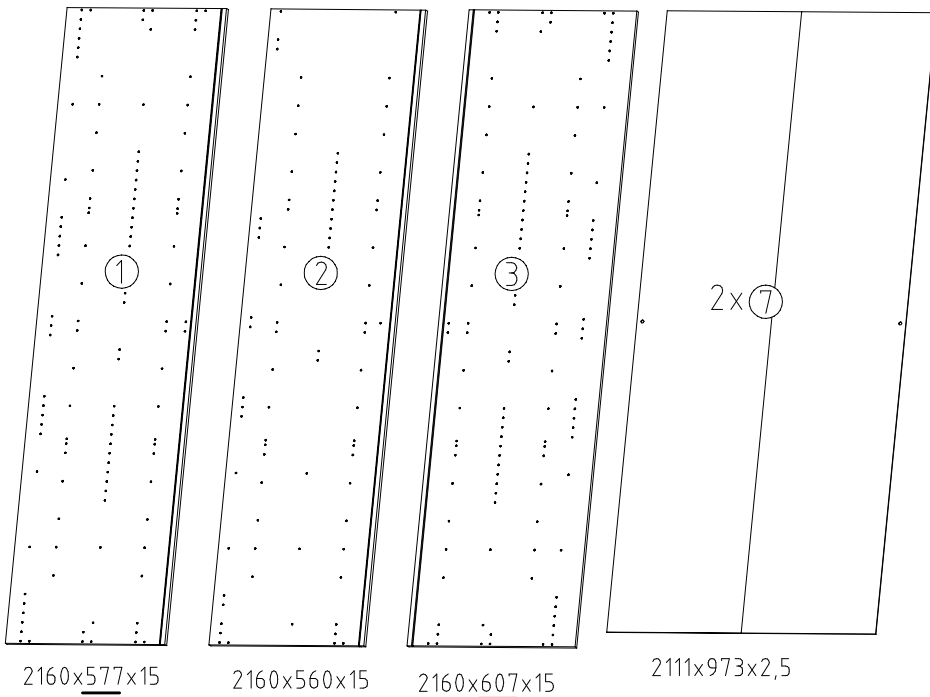
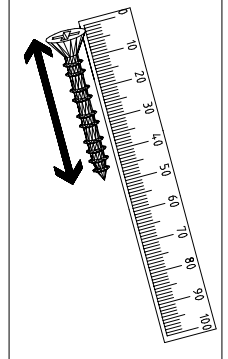
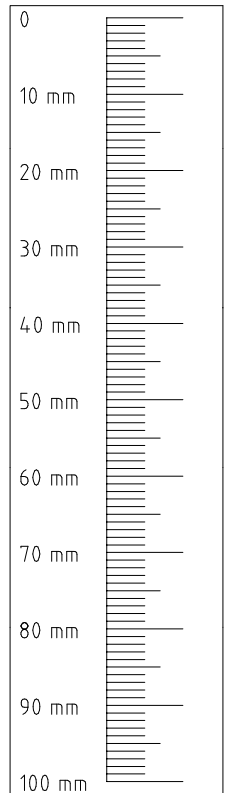
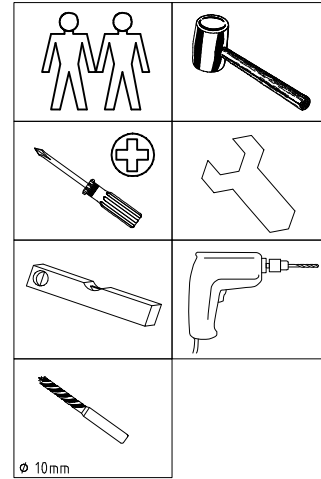

1

3,5 x 15 mm

G1

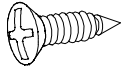

121 370

S0

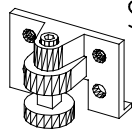

111 xxx

A1



111 xxx

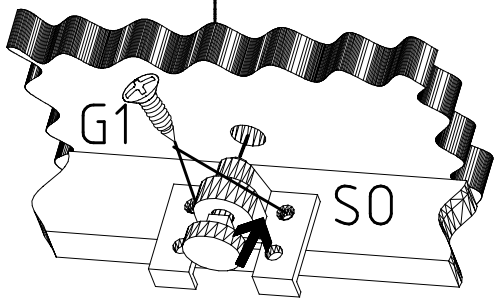
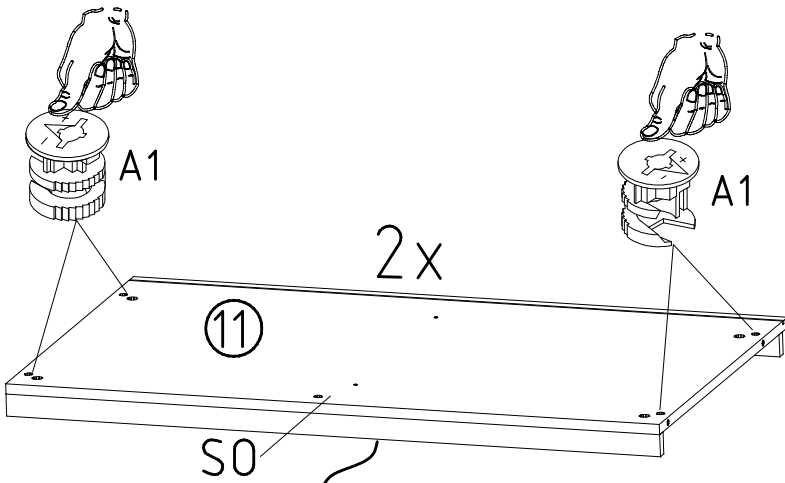

2

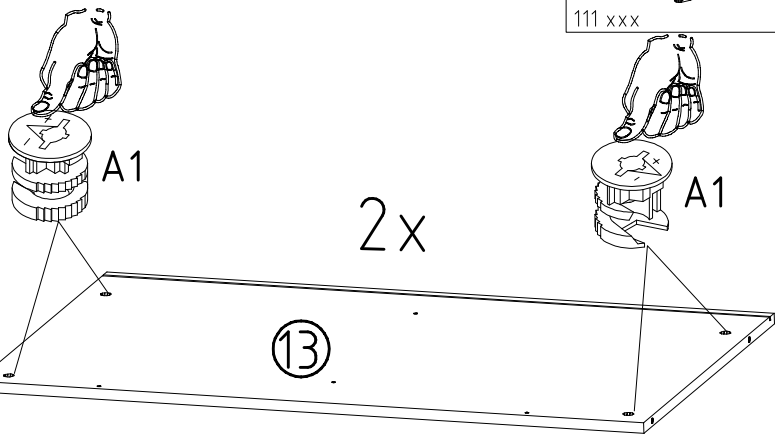

A1



111 xxx

3

F3



2

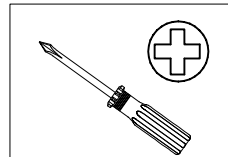

6,3 x 10,5 mm T1

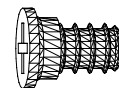

112 055

3,5 x 15 mm

G1

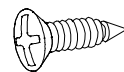

121 370

S0

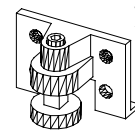

111 xxx

F3

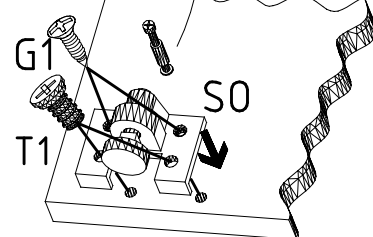
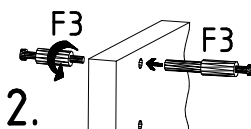
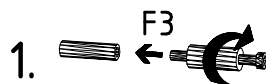
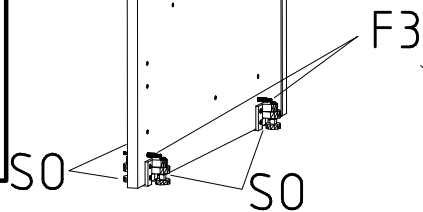
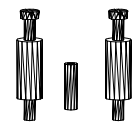

4

SWH-SKL

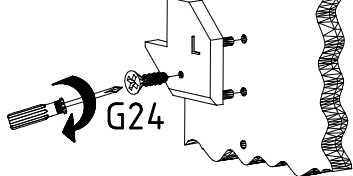

SWH-SKR

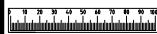
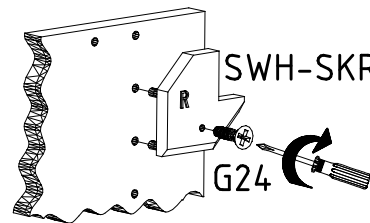

577

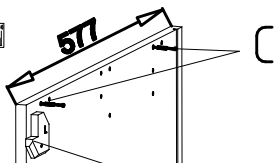

SWH-SKL + G24

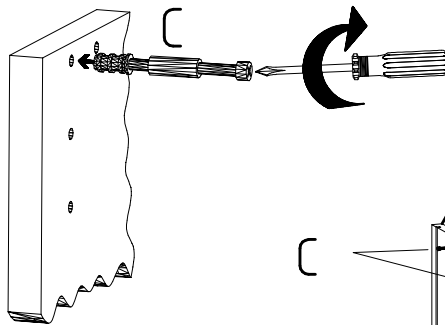

607

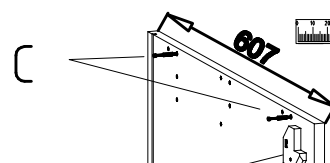
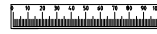

SWH-SKR + G24

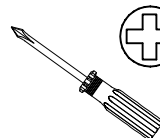

SWH-SKL

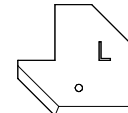

SWH-SKR

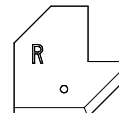

3,5 x 22 mm

G24

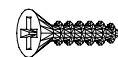

121 004

6,3 x 10,5 mm

T1

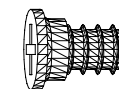

112 055

3,5 x 15 mm

G1

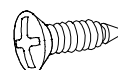

121 370

C

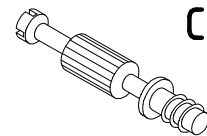

111 103

SO

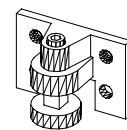

111 xxx

1

3

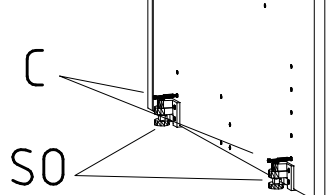
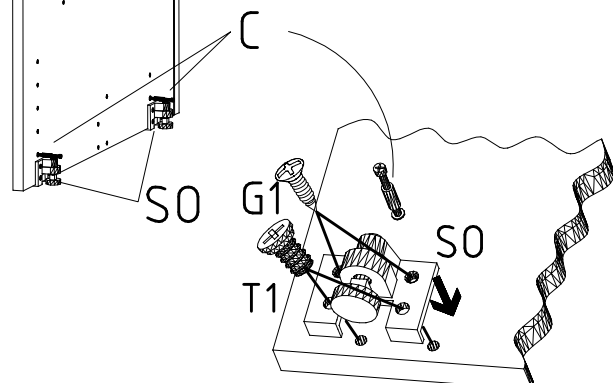

5

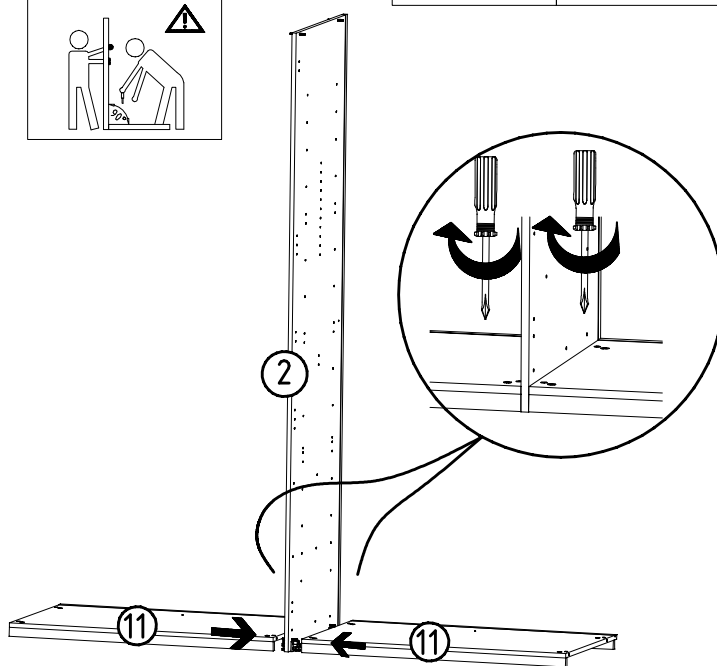
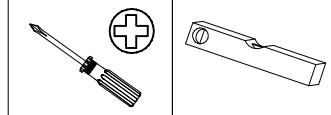

6

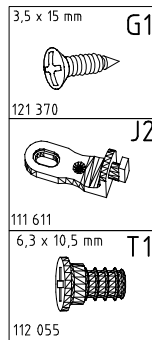
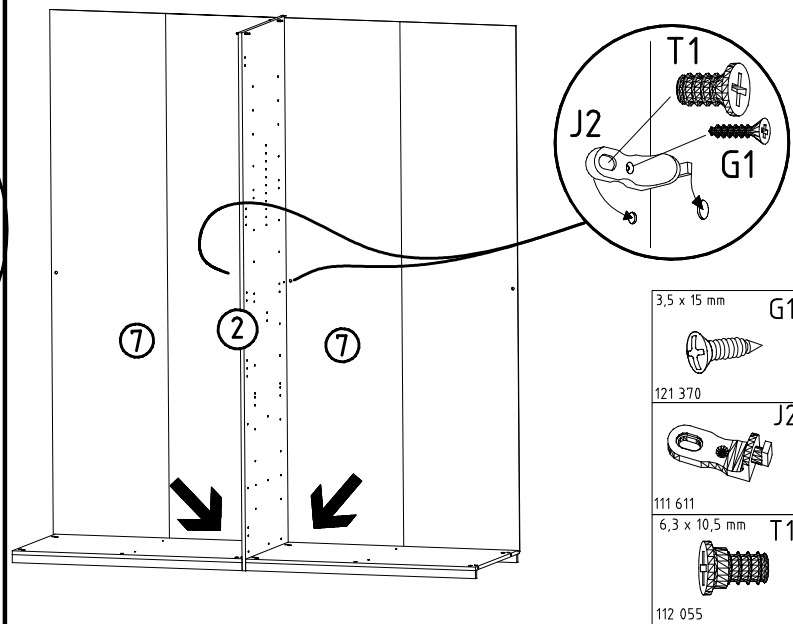
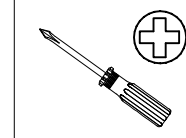

7

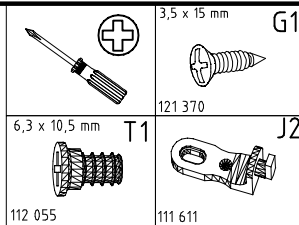

8

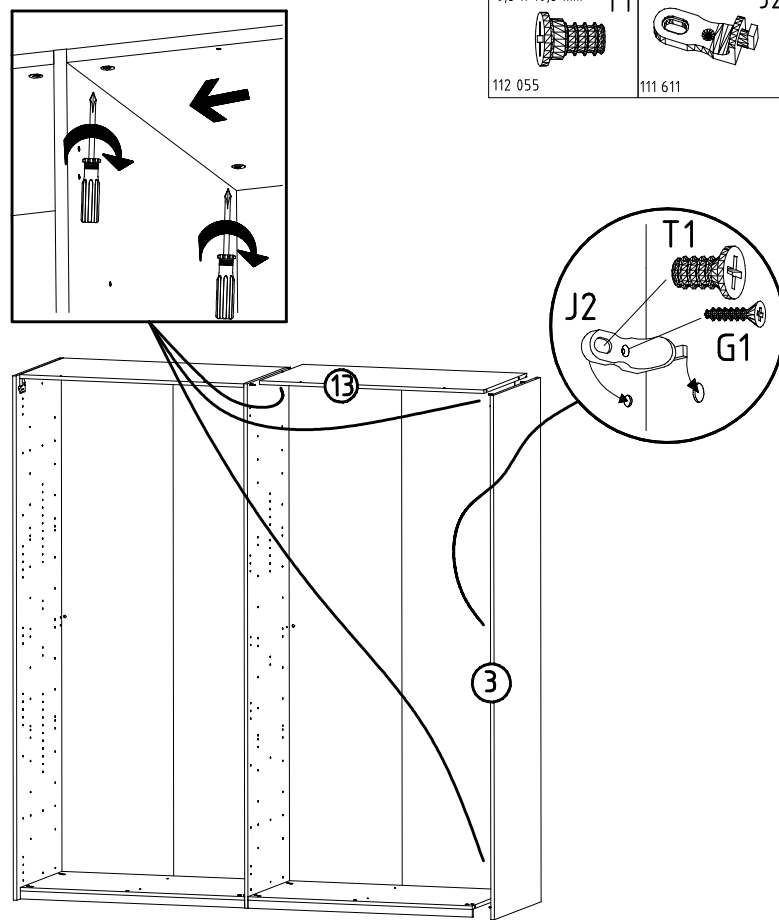
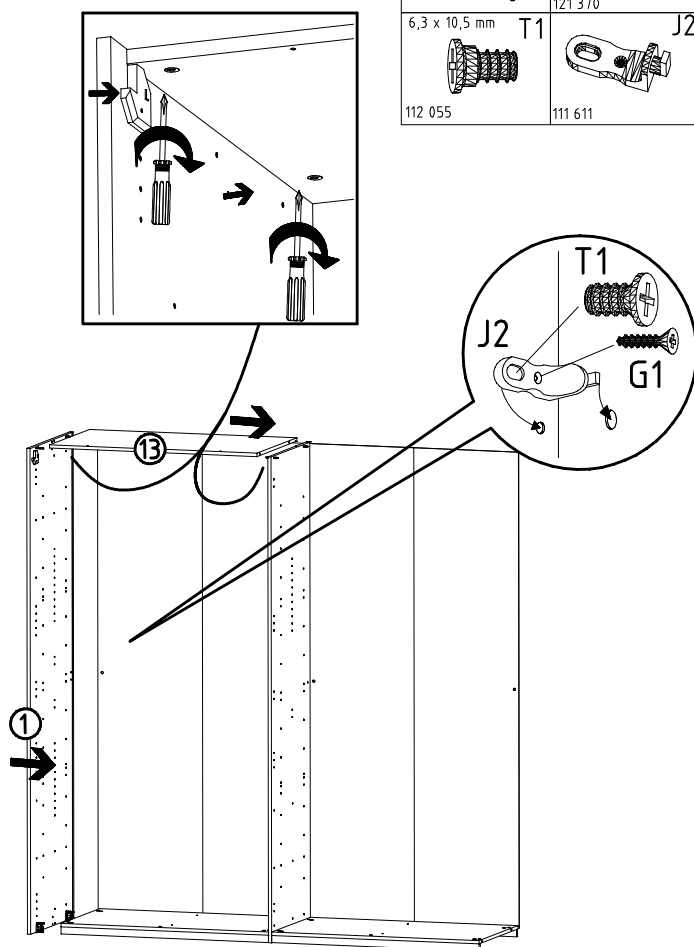
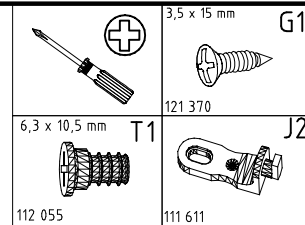

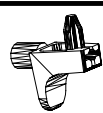
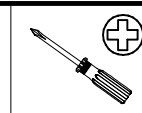

L8

111 607



K2

117 002

3,5 x 15 mm

G1

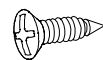

121 370

K10

100cm

112 400

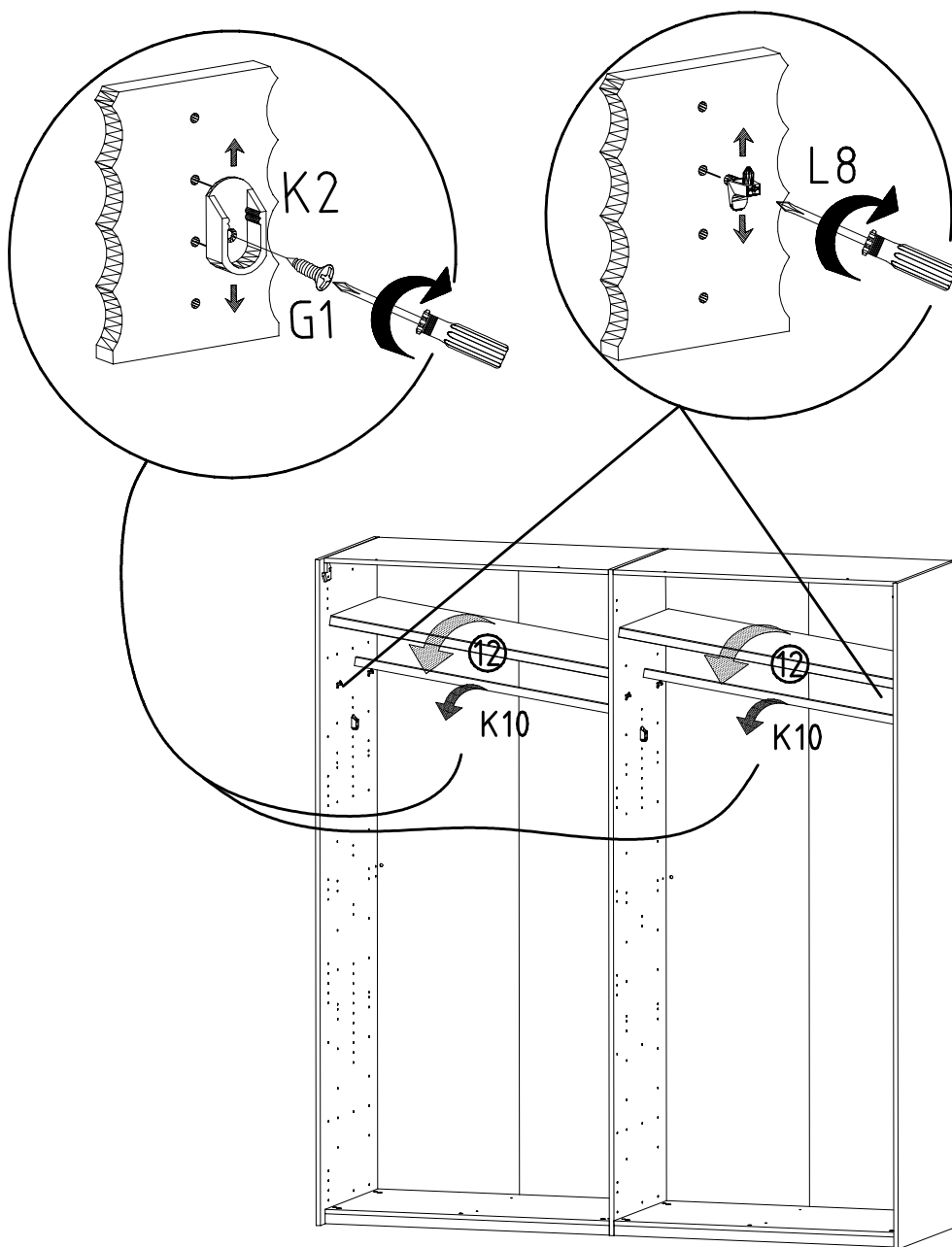

10

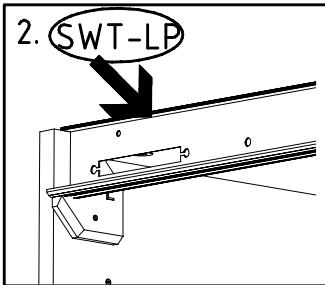
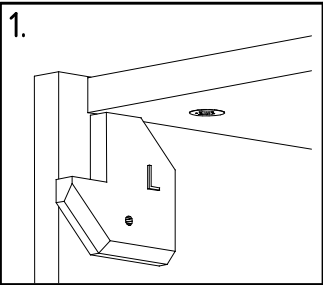

M4 x 10 mm G43 121 xxx	M4 x 13 mm GH13 121 xxx	3,5 x 35 mm G14 121 375	SWT-ST	SWT-SM5
------------------------------	-------------------------------	-------------------------------	--------	---------

SWT-LP
1453/1940/2430/2920
/3410 SY

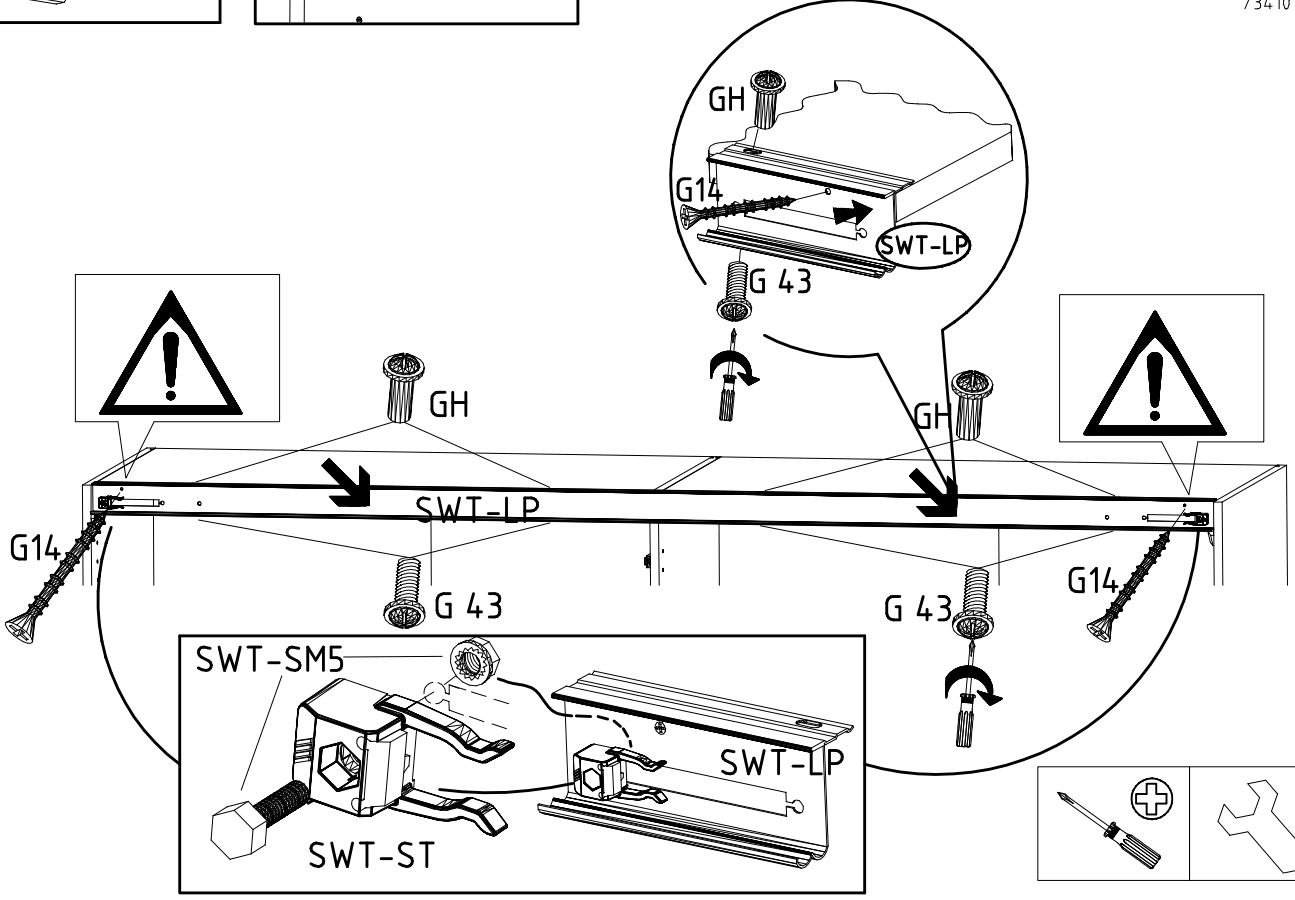

11

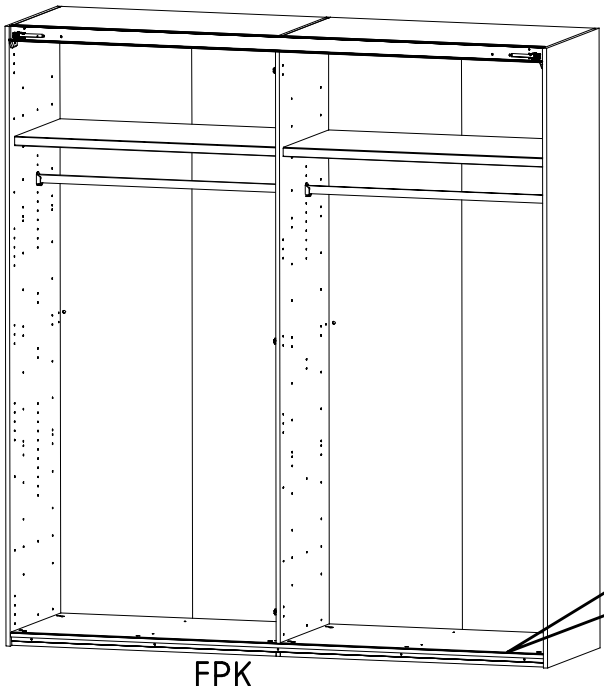

FPK
1453/1940/2430/2920/3408

3,5 x 22 mm G24 121 004

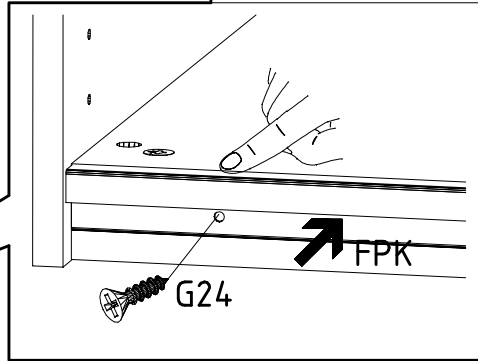

12

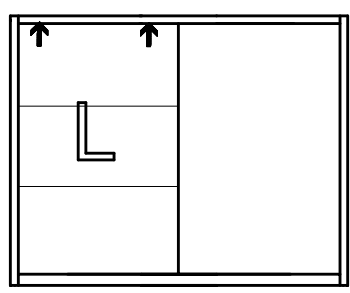
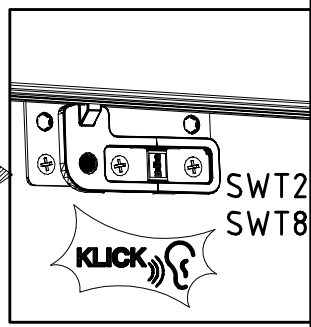
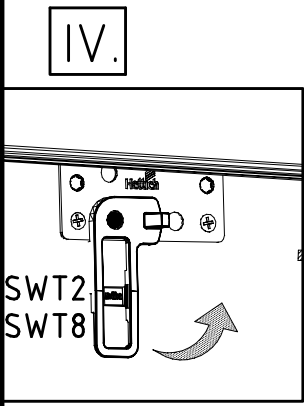
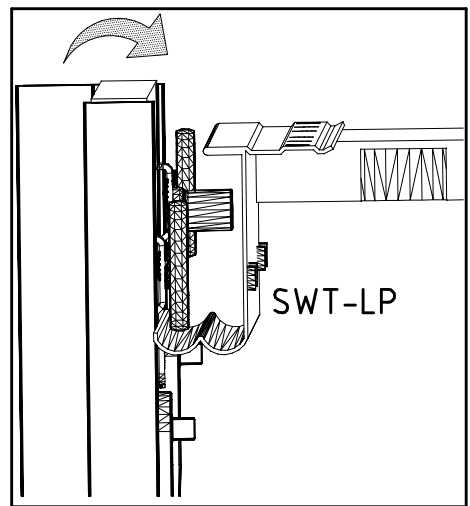
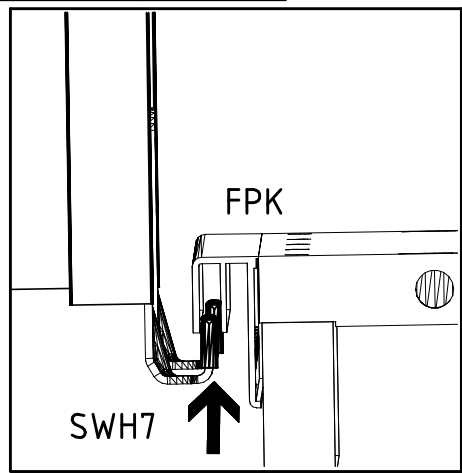
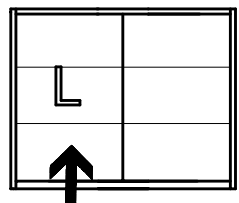
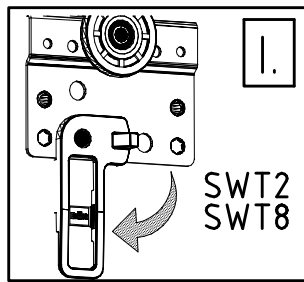

13

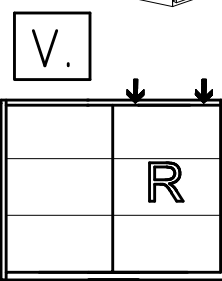
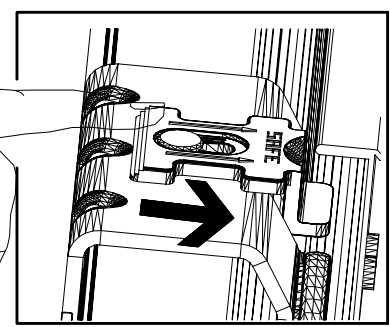
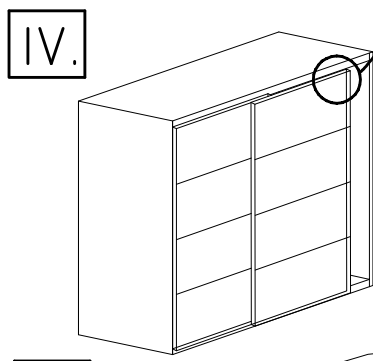
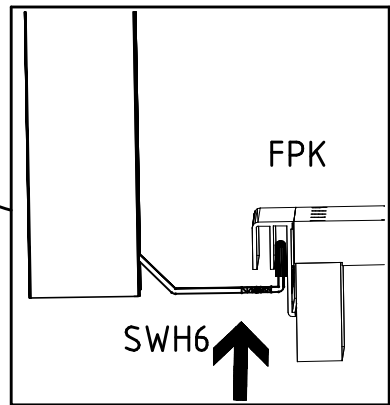
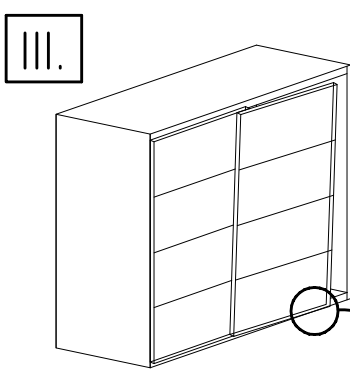
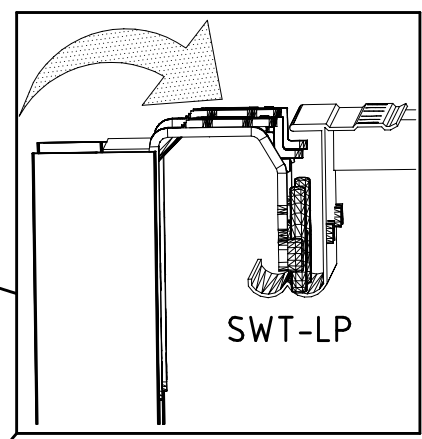
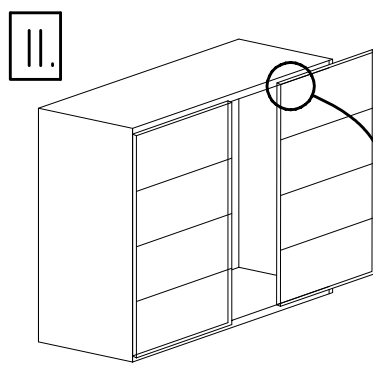
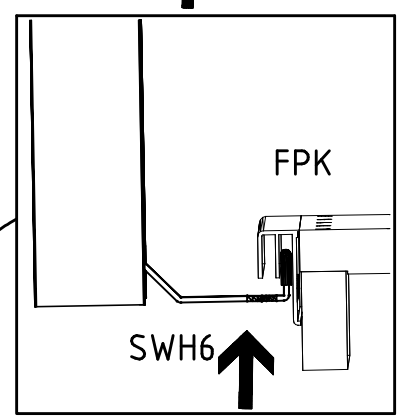
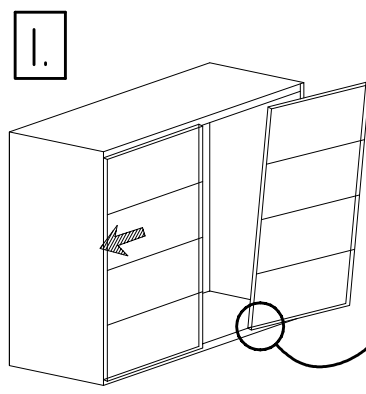
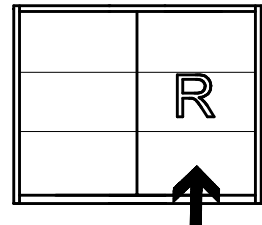
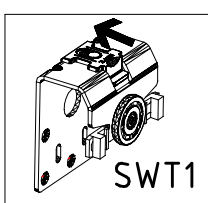

14

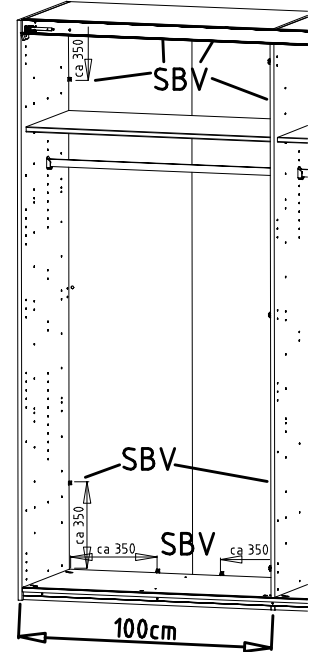
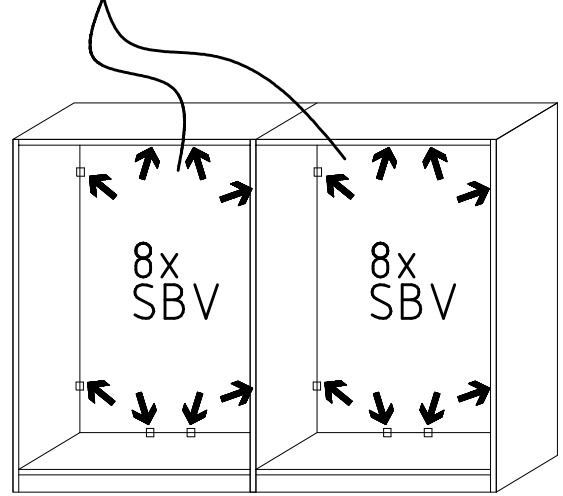
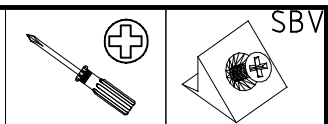
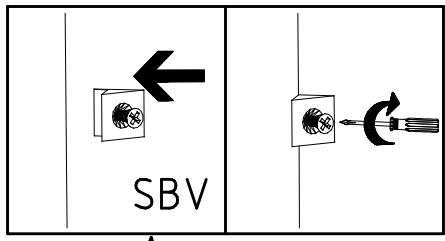

15

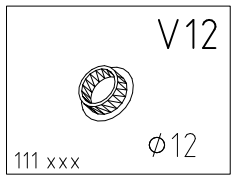
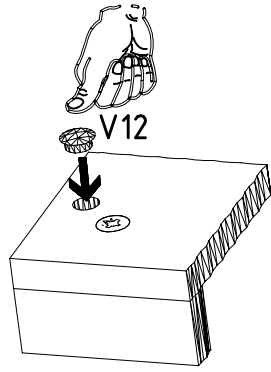
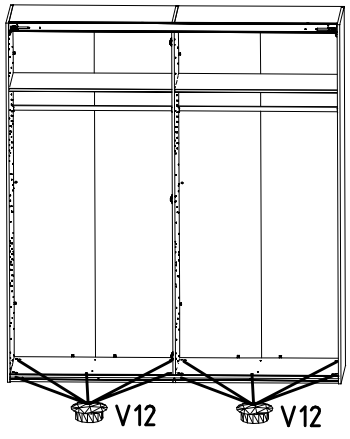

16

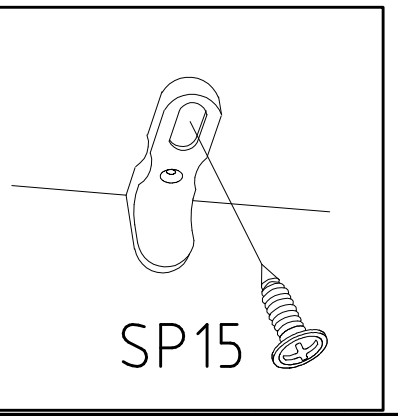
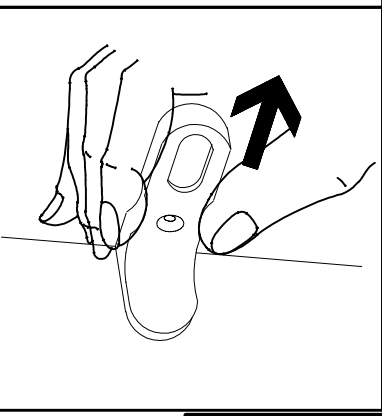
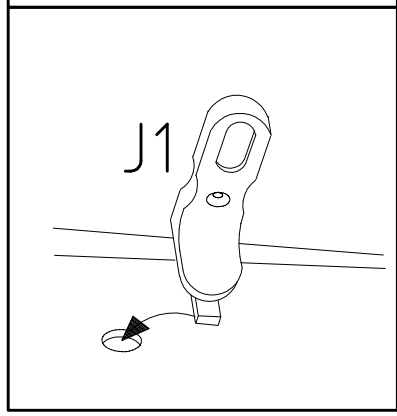
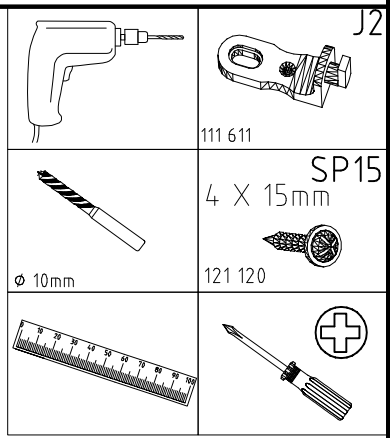
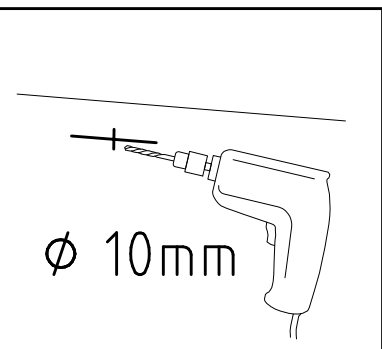
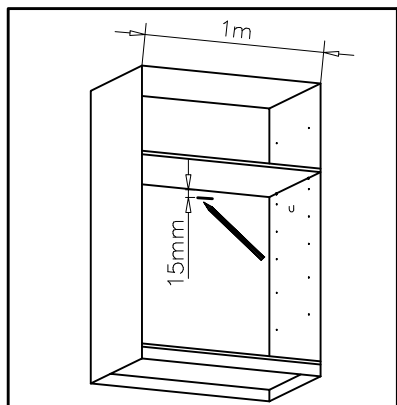

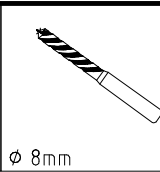
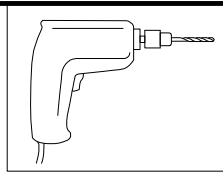

ø 8mm

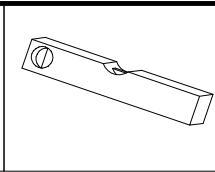
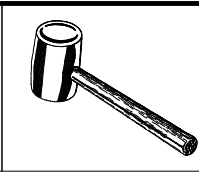

SP15
4 X 15mm
121 120

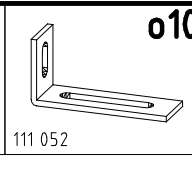

o10

111 052

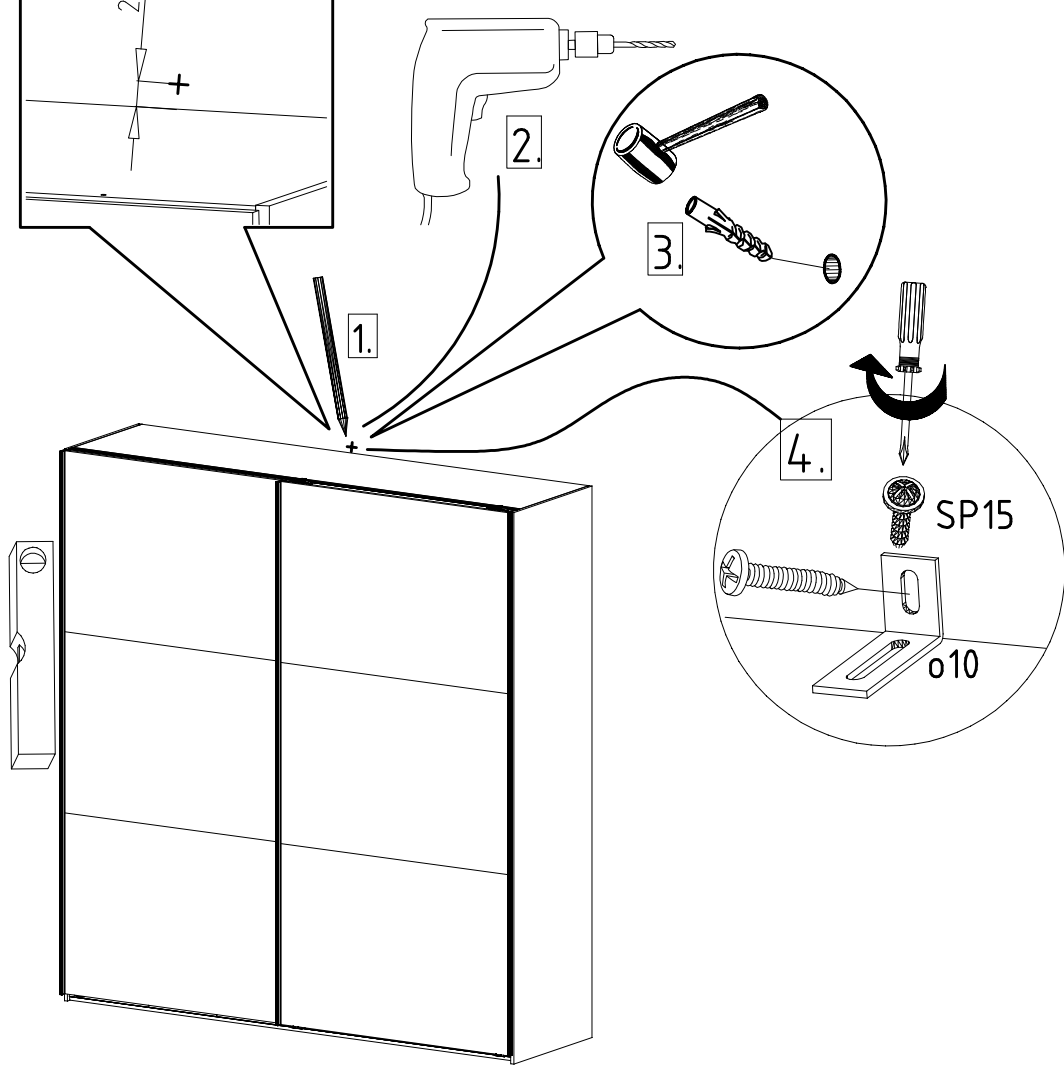
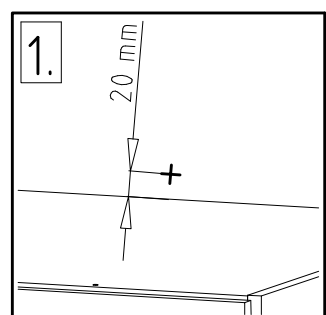
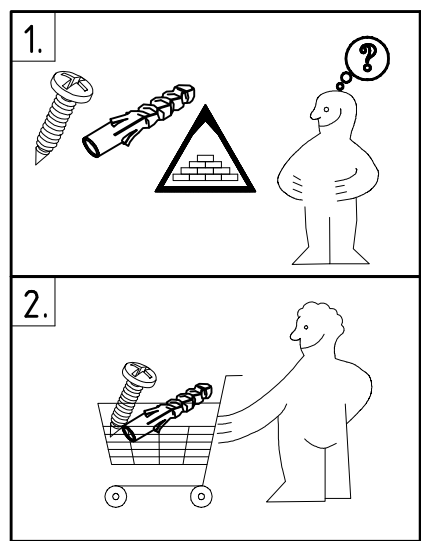

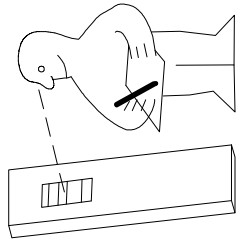
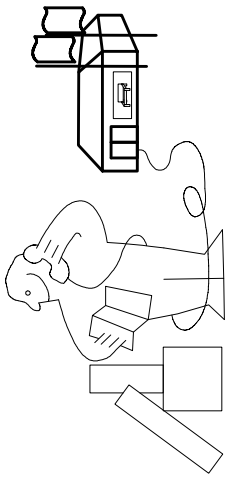
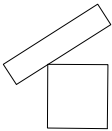
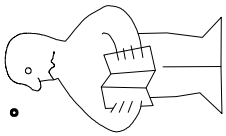

Modell/Model/Modèle



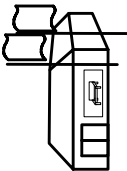

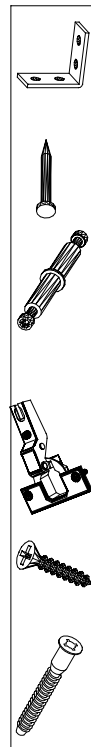

{121 370}	{ G 1 }	{4x}

Änderungen die dem technischen Fortschritt geschuldet sind, behalten wir uns vor!
Bei nicht vorschriftsmäßiger und/ oder nicht fachmännischer Montage wird bei Personen- und/ oder Sachschäden keinerlei Haftung übernommen.

WIMEX Wohnbedarf/ Import Export Handels GmbH/ Postfach 1407/ 49112 Georgsmarienhütte/ Germany
Tel.:(+49) 054-01 8598 16/17 Fax.:(+49) 054-01 8598 33 Mail: service_H@wimex-online.com

104P-Nr. / 104P-No. 150X-Nr. / 150X-No. Auftrag/Order-No. / No. de commande

23203 **30110XY** 104

Kunde MAX MUSTERMANN
Customer
Client

Kommission / your order reference / votre reference

3377 MINDEN

Dekor / Decor Decor / Modell / Model

F99 **SAMPLE**

F99842 SCHWEBETUERENSCHRANK 250 CM H 216CM
PLANKENEICHE NB + RAU STEEL
PLANKENEICHE NACHBILDUNG

202320301107241476000001

Paket / Package / Paquet

414760

SOCKEL

Paket 1 von 8 Colli Kommission 10

HSP-SMT BOD 50 TEXT/TEX SOCKEL 32 FRESH TV / LF 104
SO-BOD TEXT RASTEX/ ZNBOD D18MM TX KLSTA

Montage - Anleitung Laenge 520,0 OBEREN
KS-64 Breite 568,0 OBEREN

SOCKEL32 KLEB

Bei Warenauslieferung für Rückgabe beachten!
En cas de livraison veuillez retourner le bordereau d'envoi.



OBEREN 5 30/19 HAUT 23.08.19 OBEREN 1 1. ABOVE OBEREN



WIMEX Wohnbedarf
Import Export Handelsges mbH & Co. KG
Werner-von-Siemens-Str. 35
D-49124 Georgsmarienhütte - Germany

SAMPLE **23.08.19**
Modellname Produktionsdatum
Model Date of manufacture

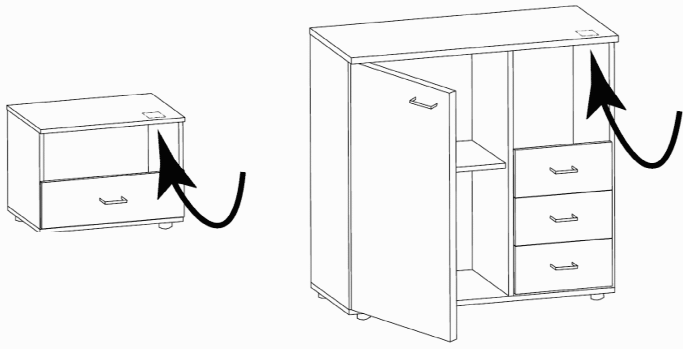
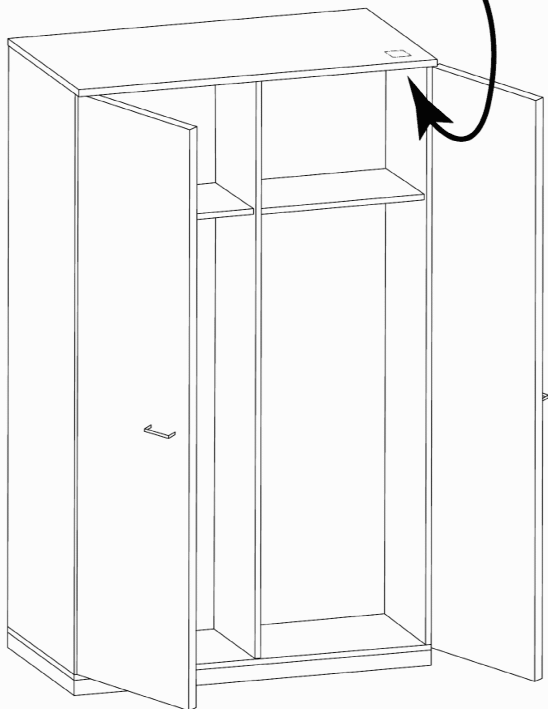
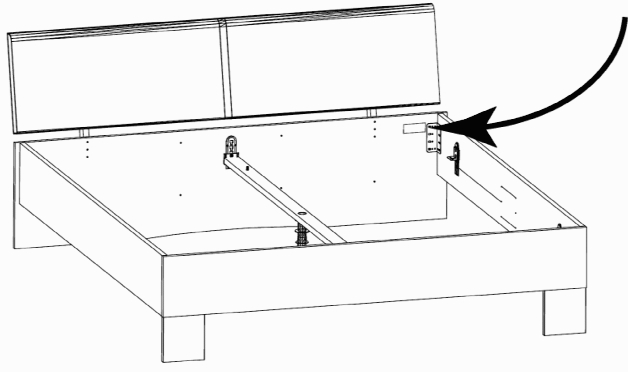

980830



1.

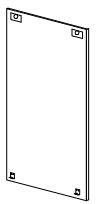

2.

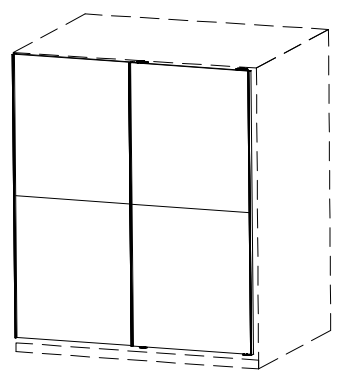
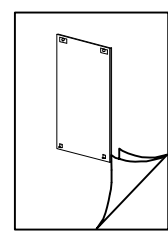
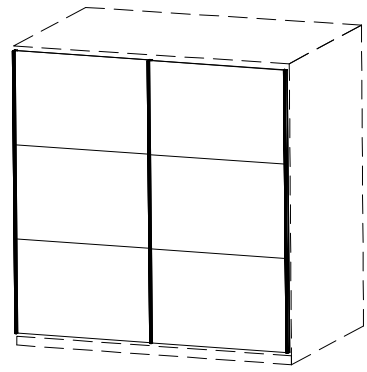
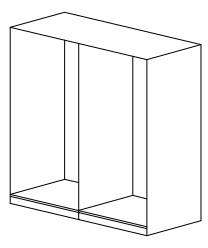
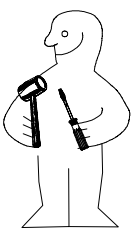

150/200/250/300 HSP

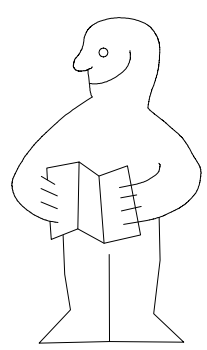
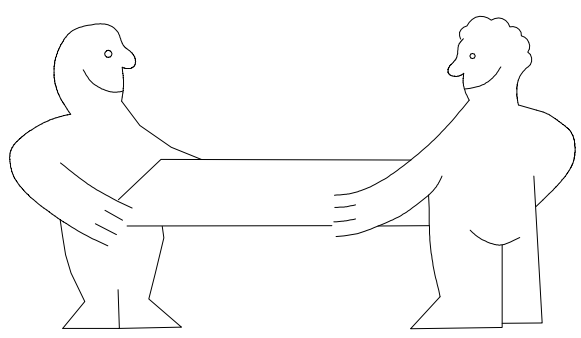
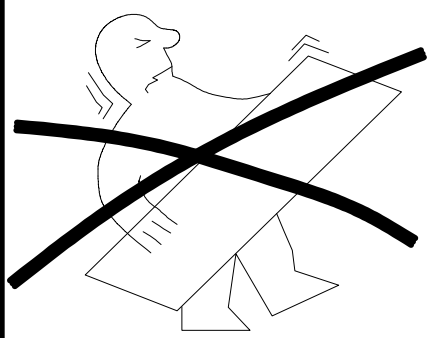

1-2-3-4... ○

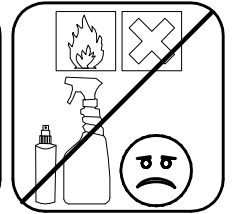
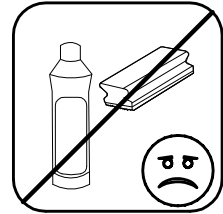
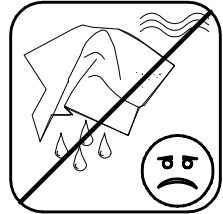
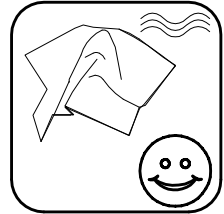
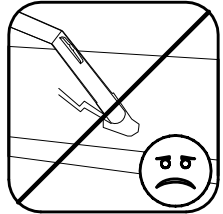
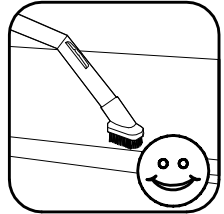
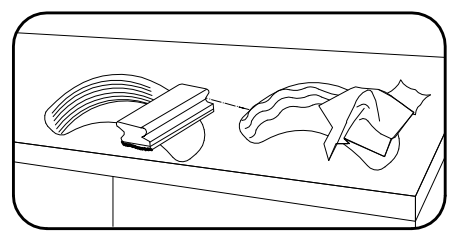
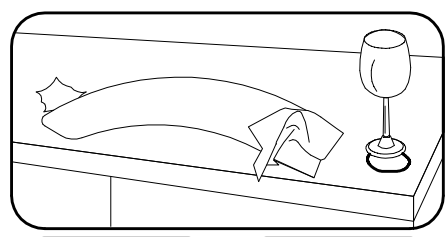
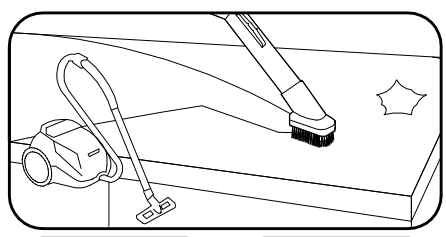
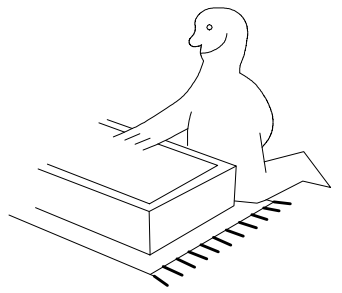
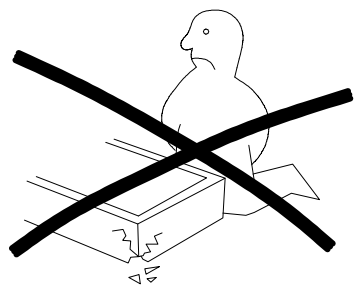
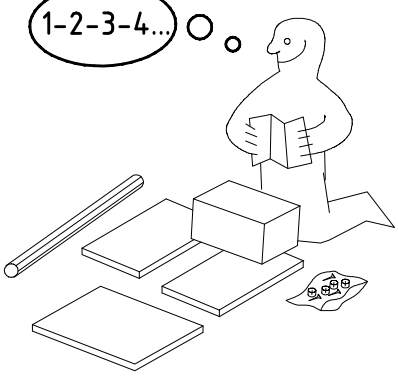



980830

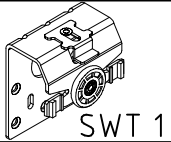
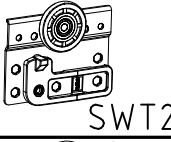
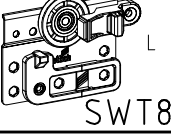

26.11.16 / -

11 16

1/11

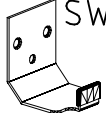
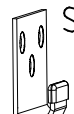
 SWT 1	2x
 SWT 2	1x
 SWT 8	1x

3,5 x 15 mm  G1 121 370	1x
 SWH 6	2x
 SWH 7	2x

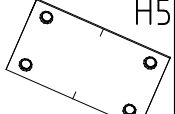
4 X 13mm  SP13 121 122	60x 68x
6,3 x 10,5 mm  T2 111 030	24x
 H5 114 183	2x 4x

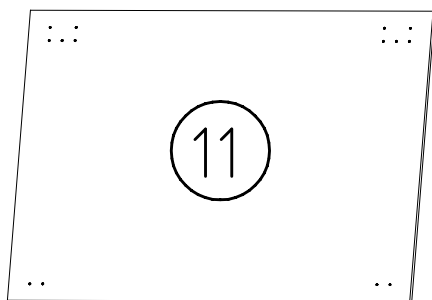
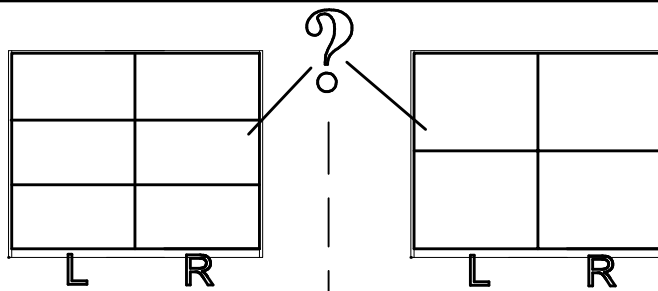
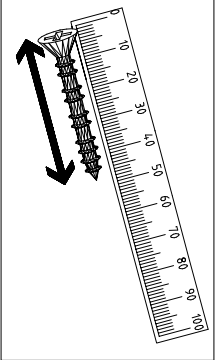
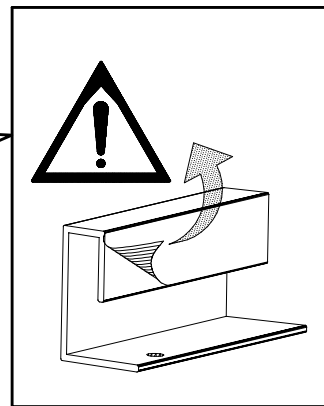
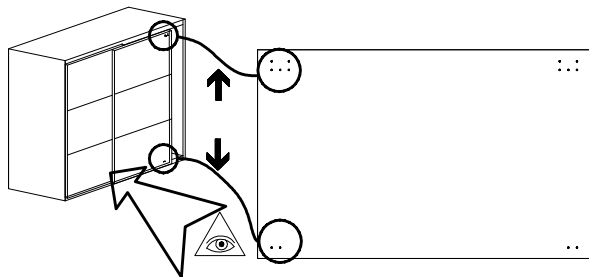
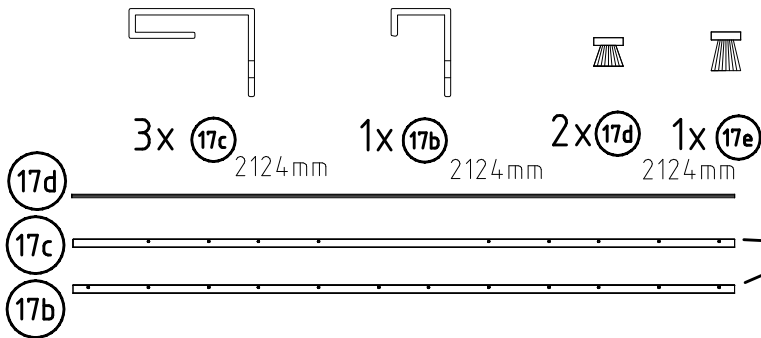
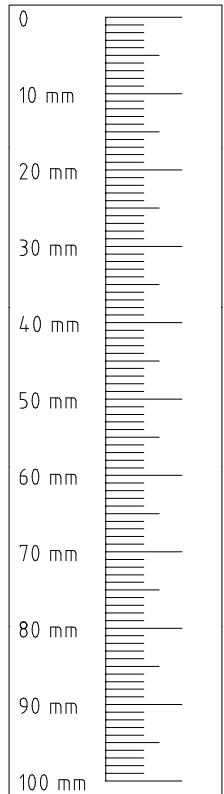
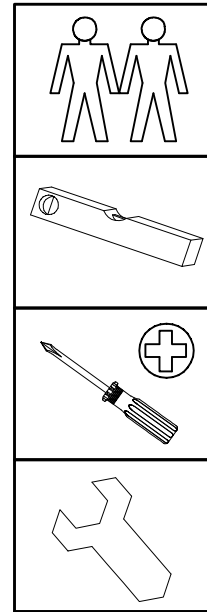

6x 745/990/1235/1485 x 708 x 15

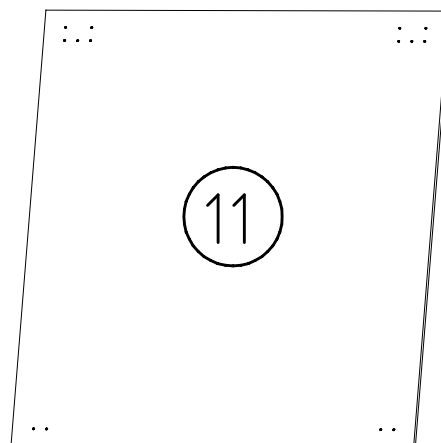
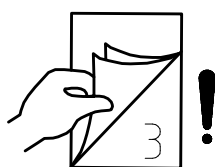

4x 745/990/1235/1485 x 1062 x 15

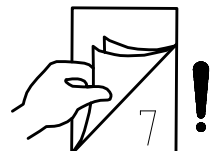

1

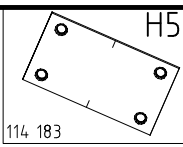
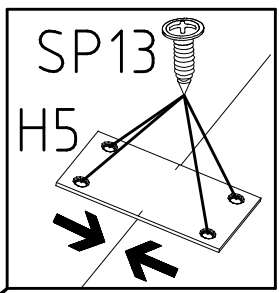
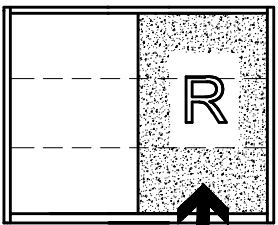

SP13
4 X 13mm
121 122

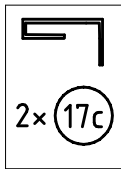
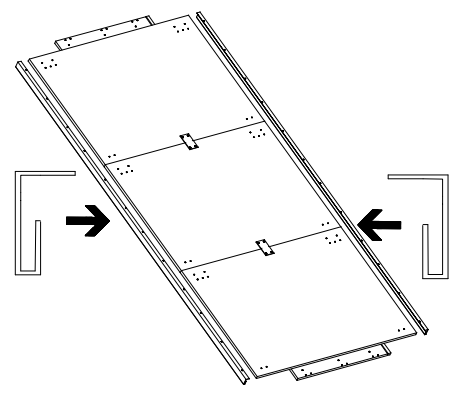
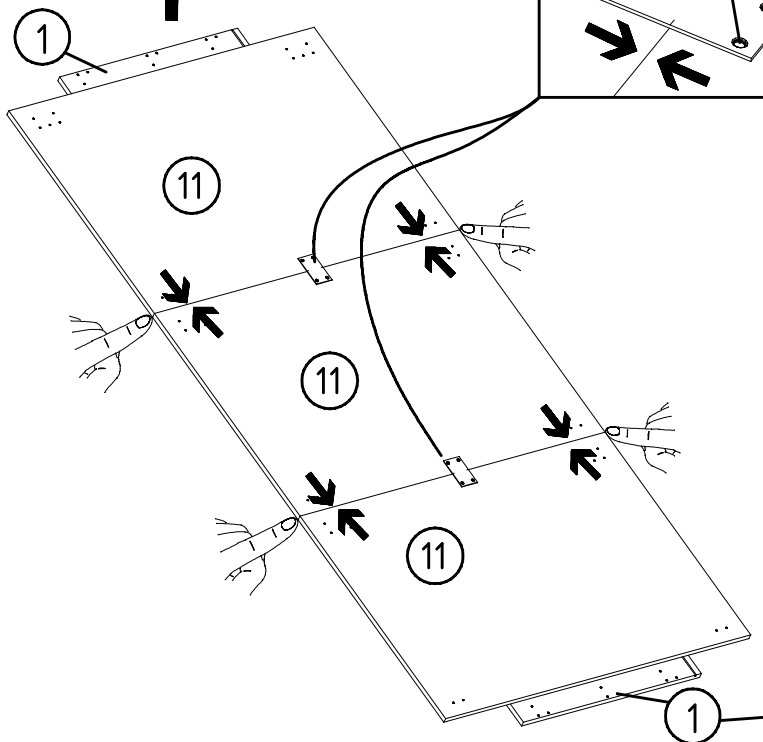
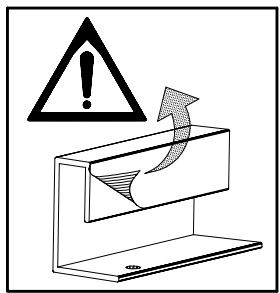
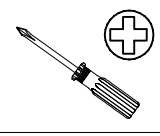

2

SP13
4 X 13mm
121 122

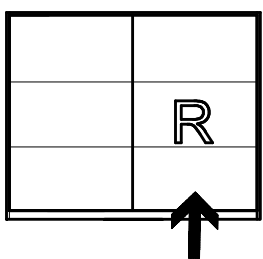
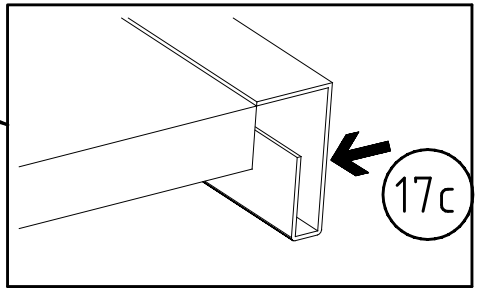
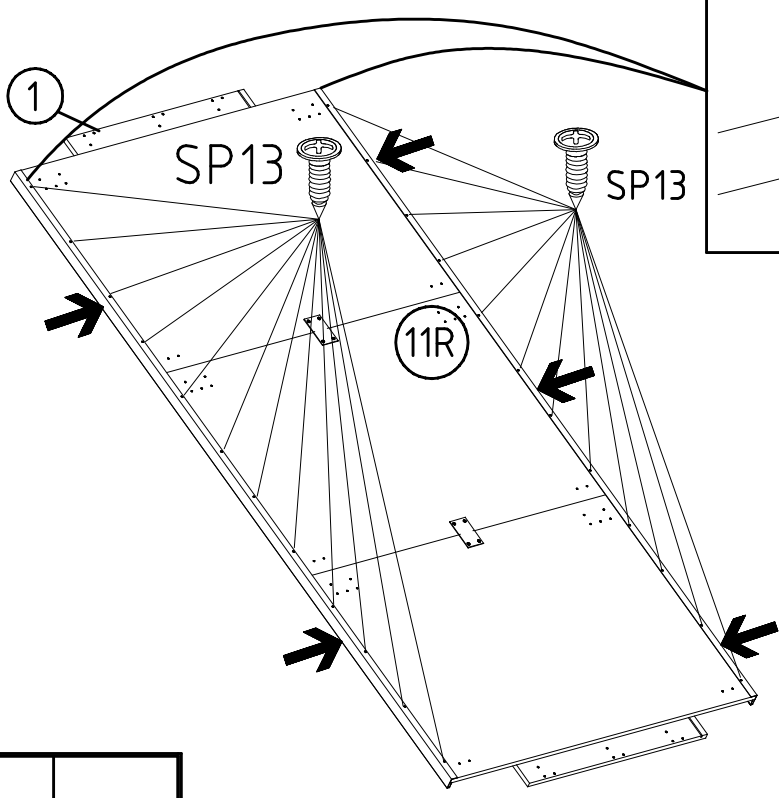
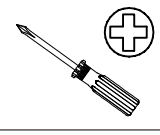

3

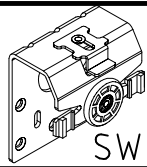

SWT 1

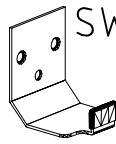

SWH 6

4 X 13mm

121 122

SP13



6,3 x 10,5 mm T2

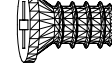

111 030

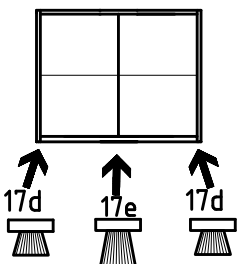
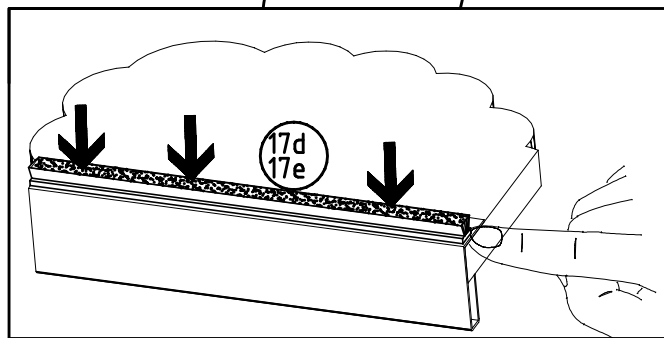
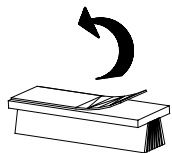
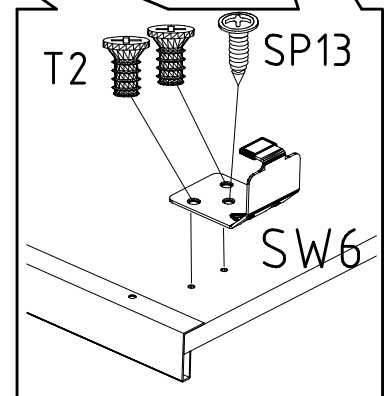
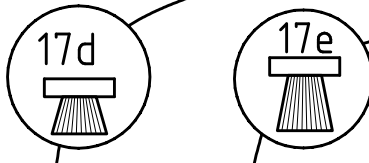
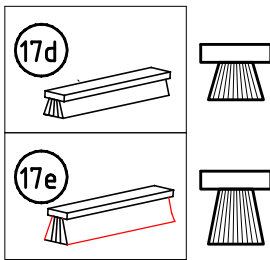
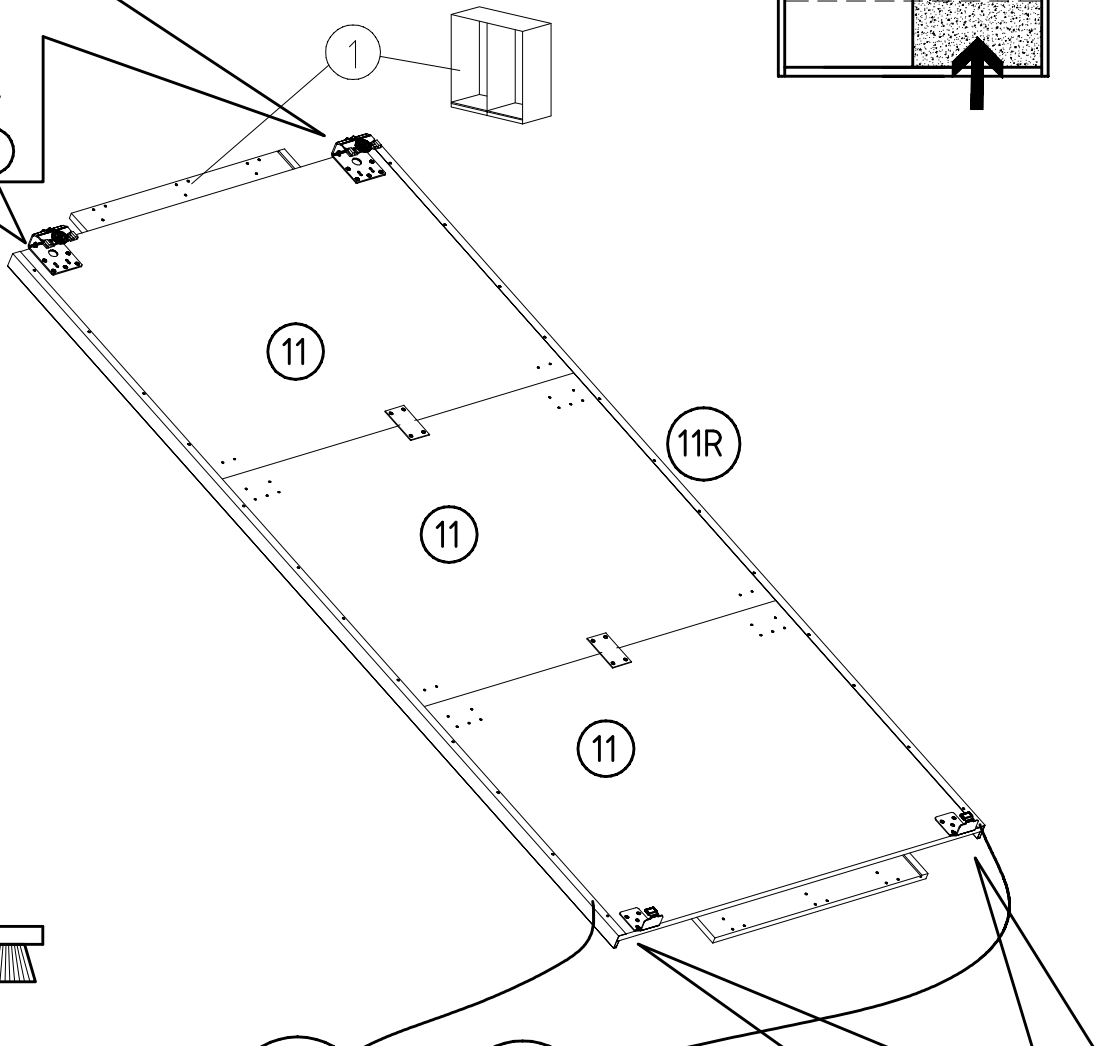
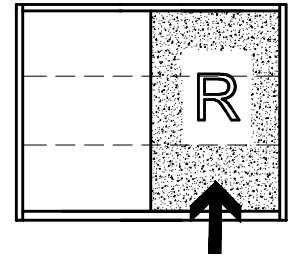
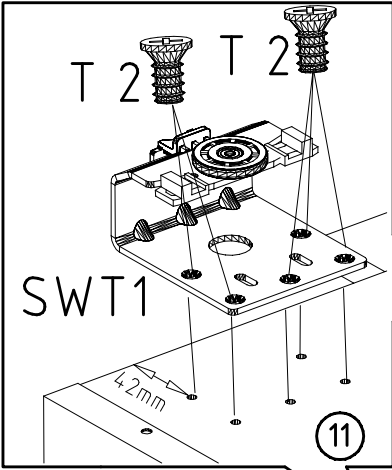
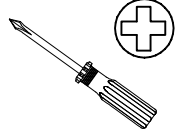

4

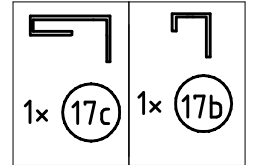
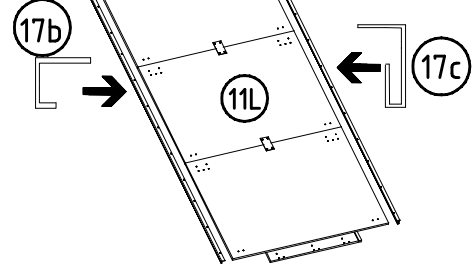
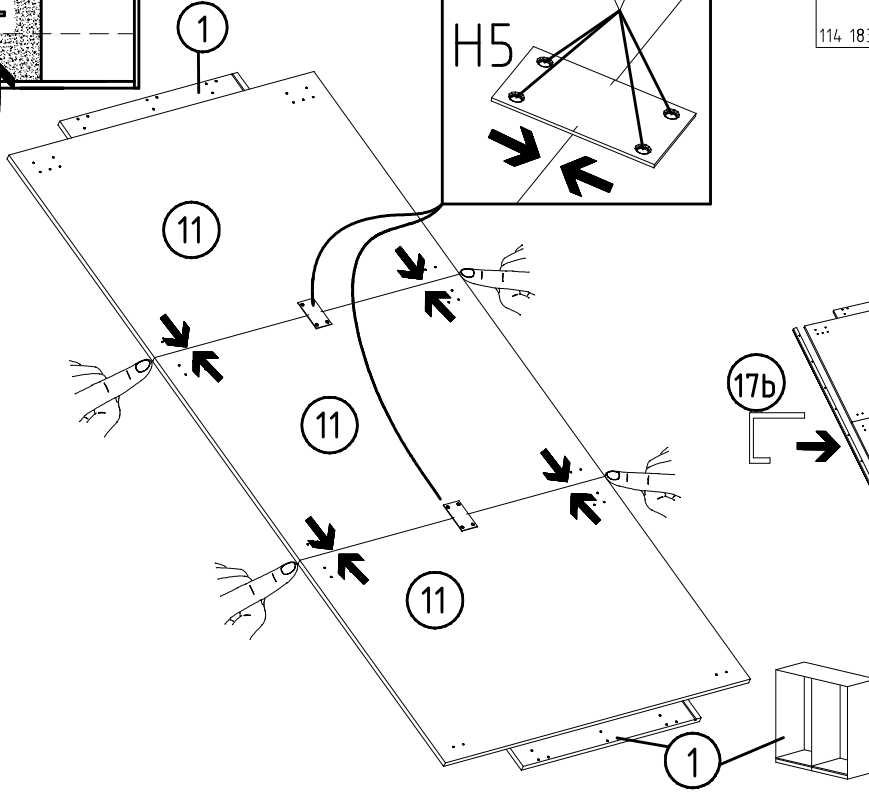
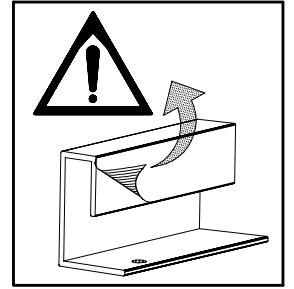
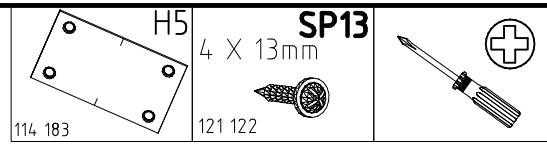
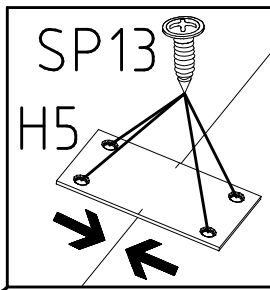
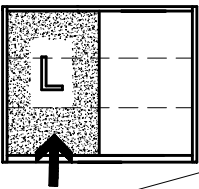

5

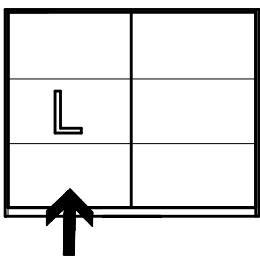
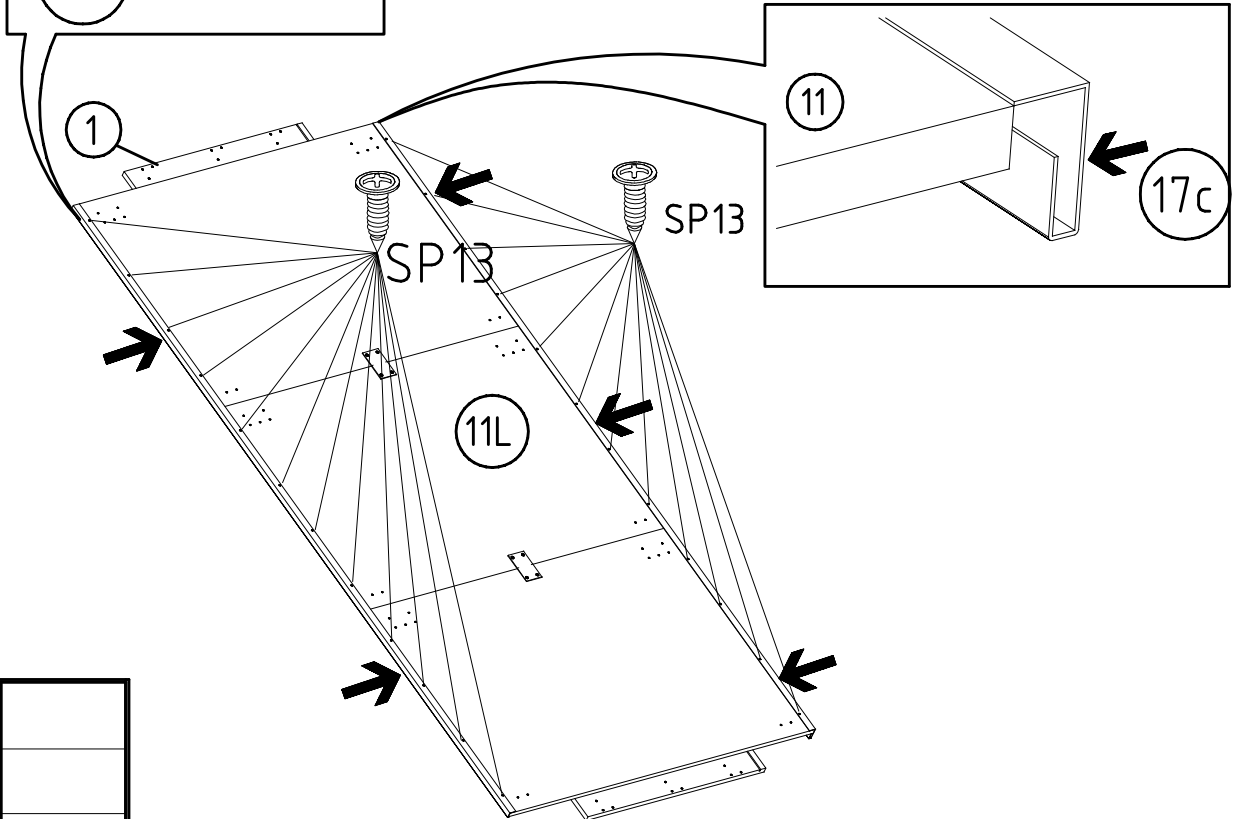
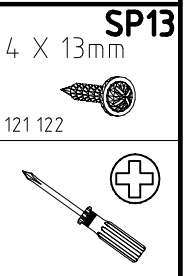
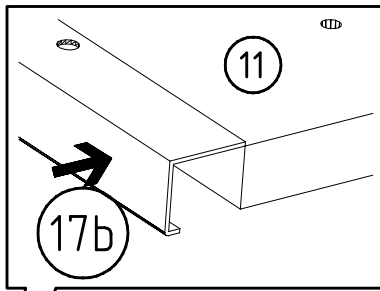

6

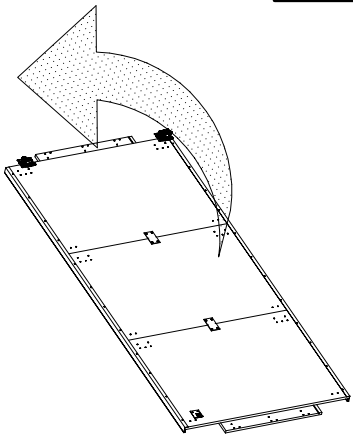
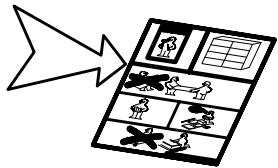
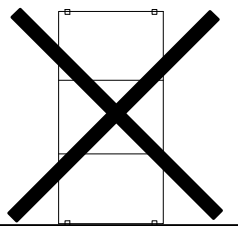
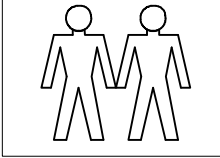
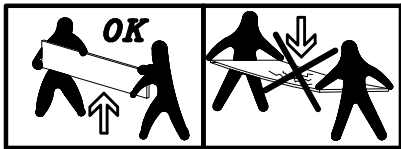
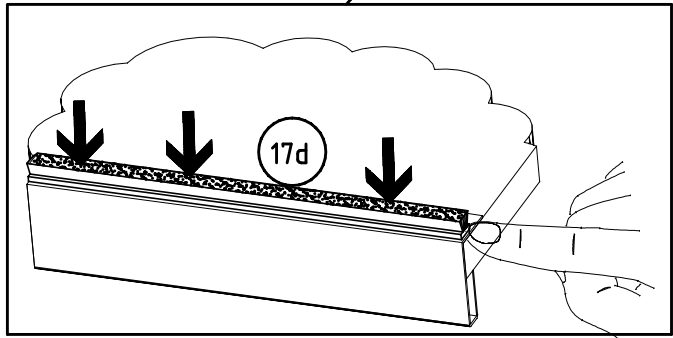
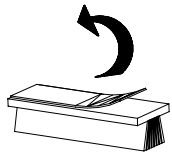
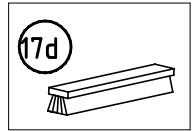
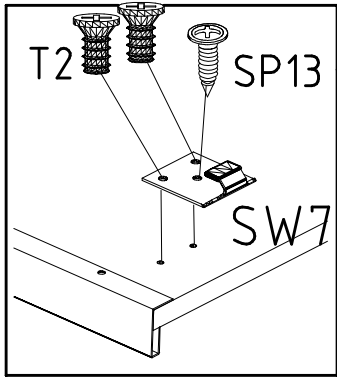
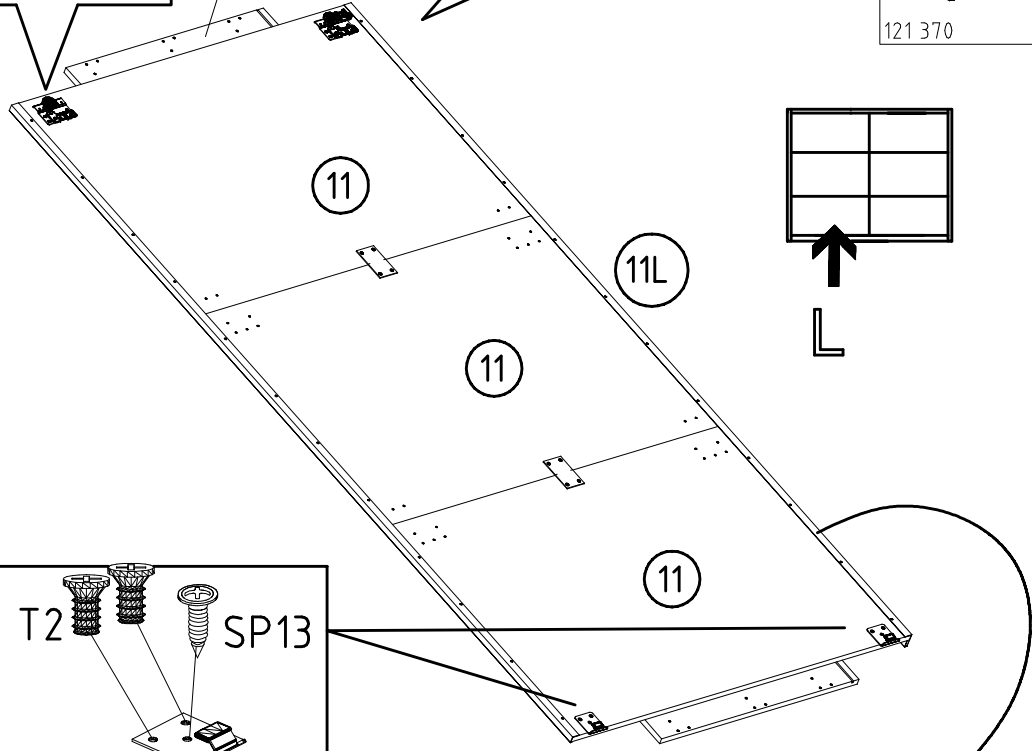
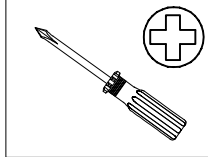
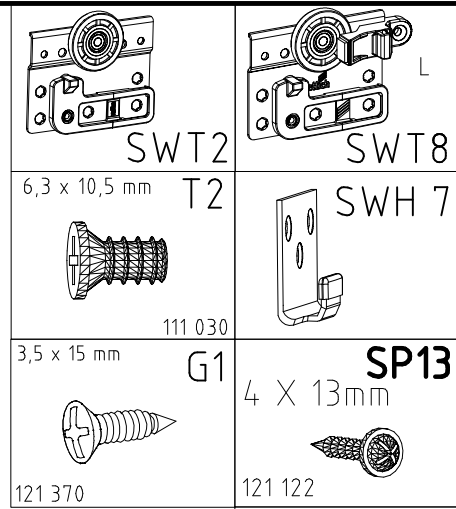
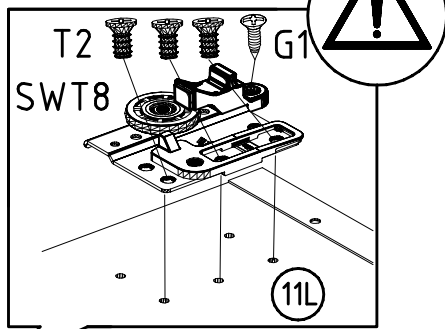
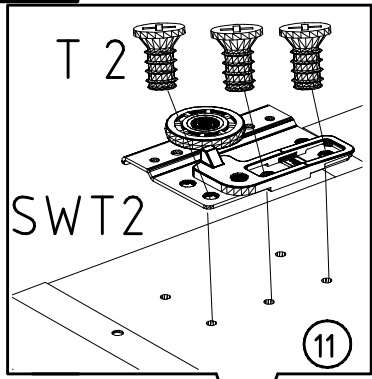

1

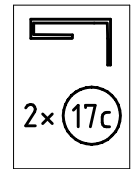
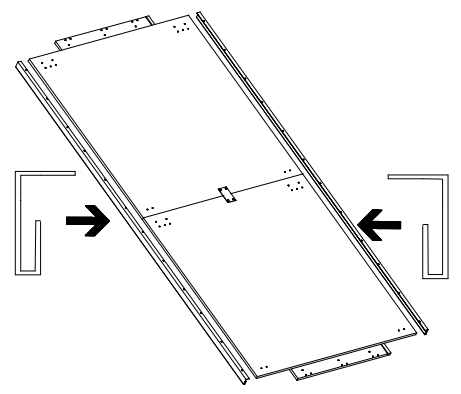
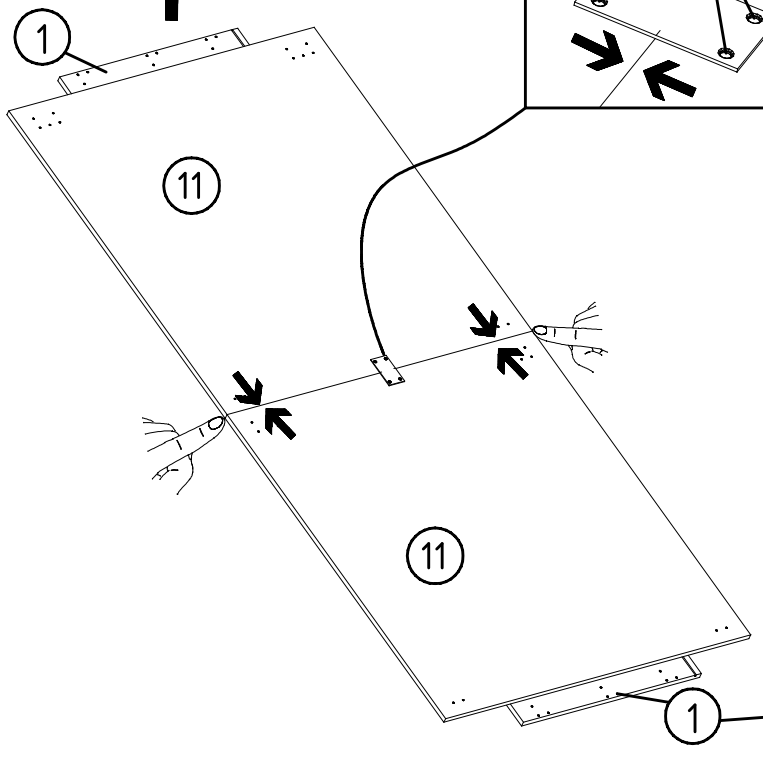
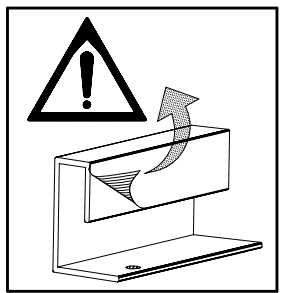
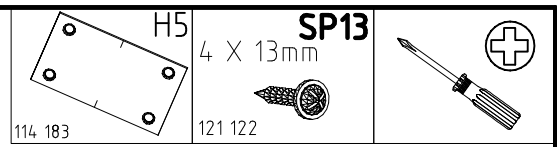
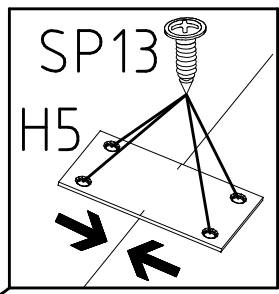
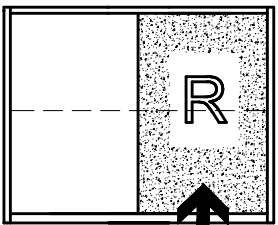

2

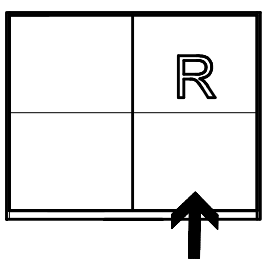
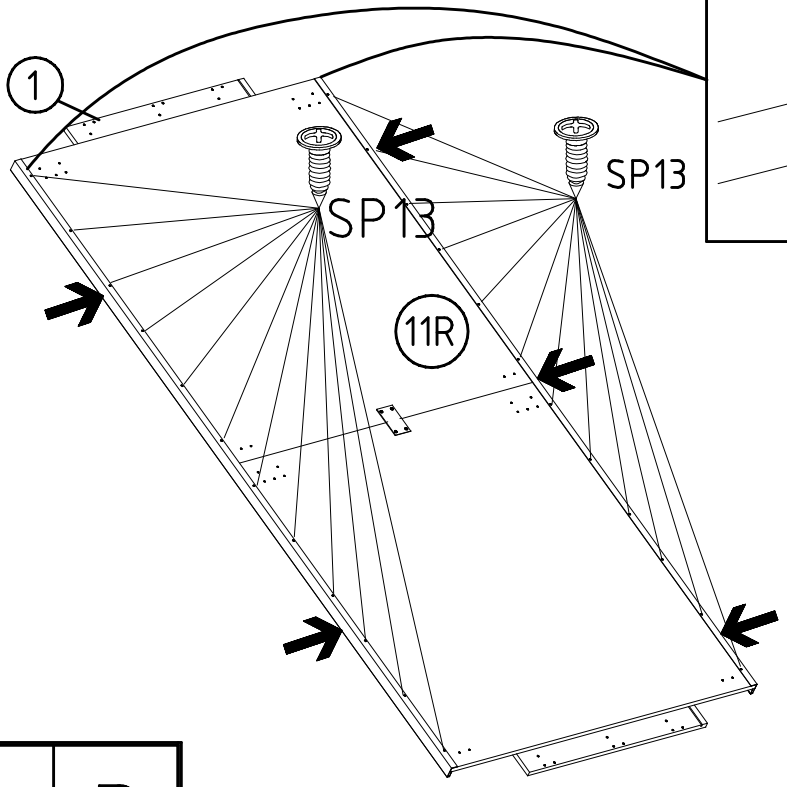
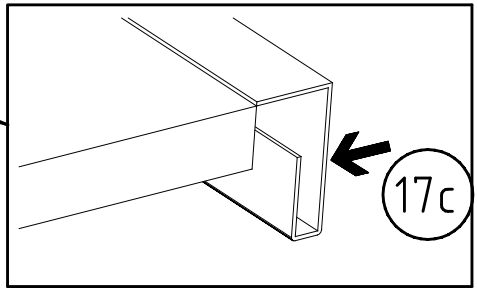
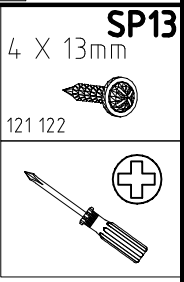

3

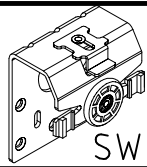

SWT 1

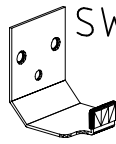

SWH 6

4 X 13mm

SP13

121 122



6,3 x 10,5 mm T2

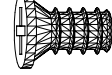

111 030

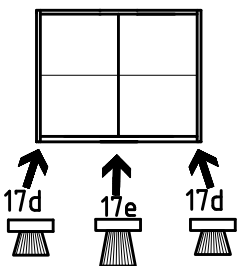
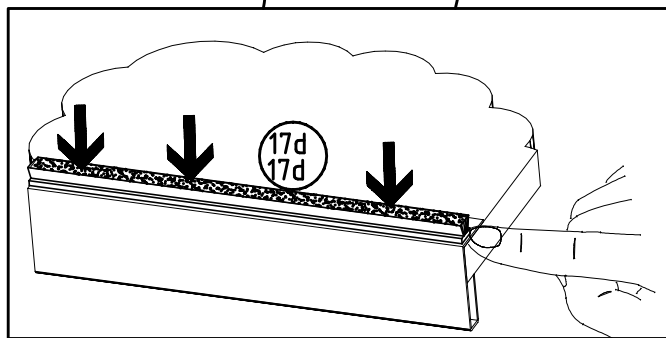
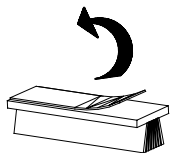
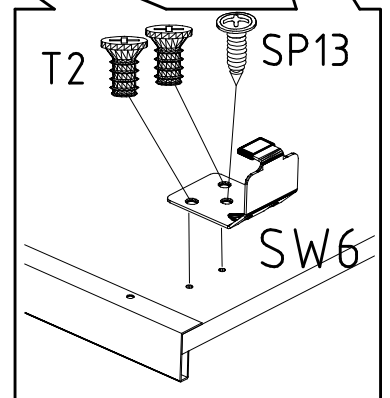
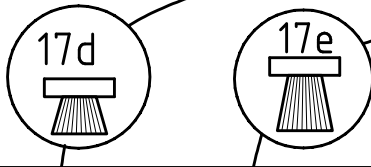
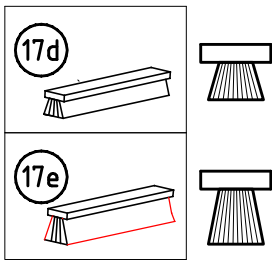
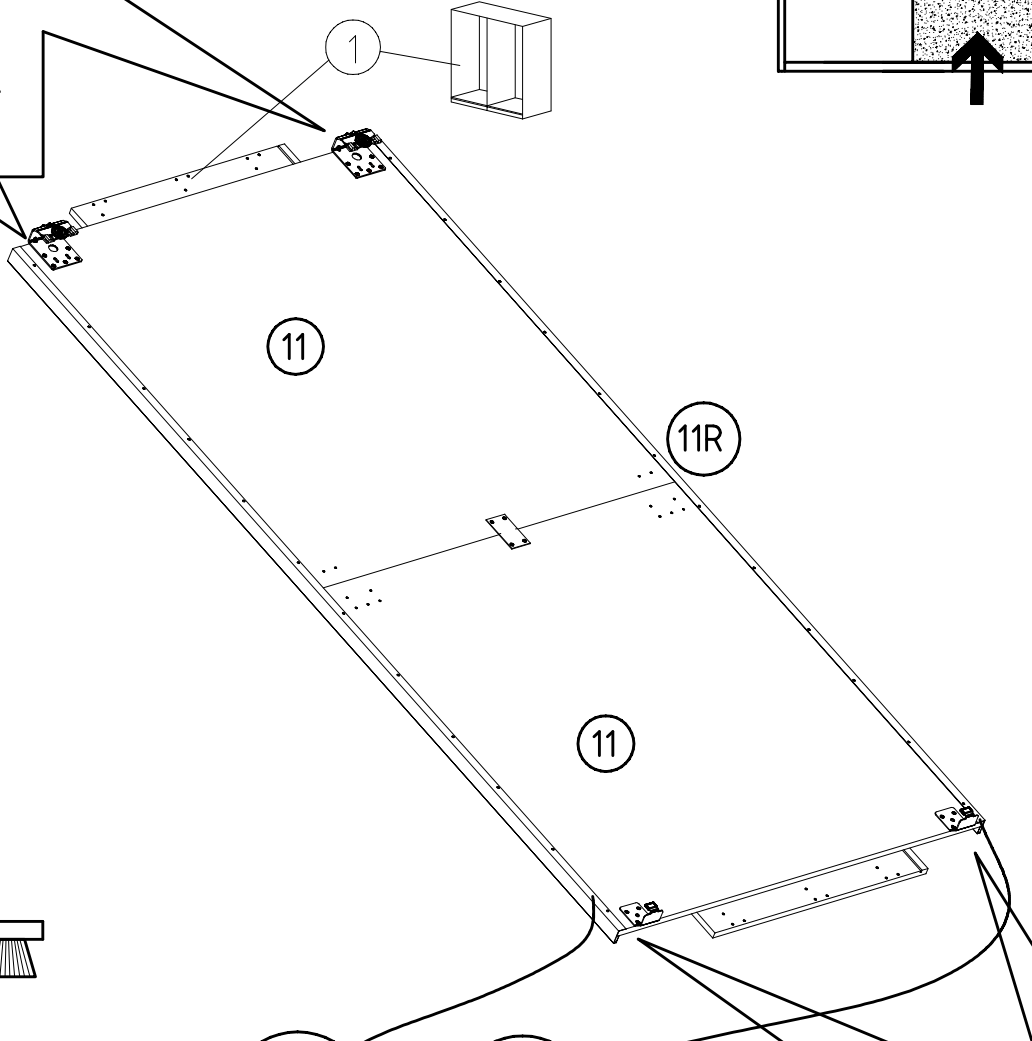
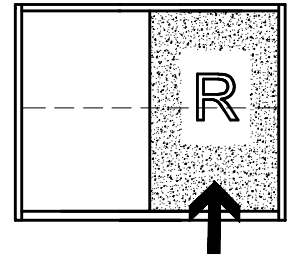
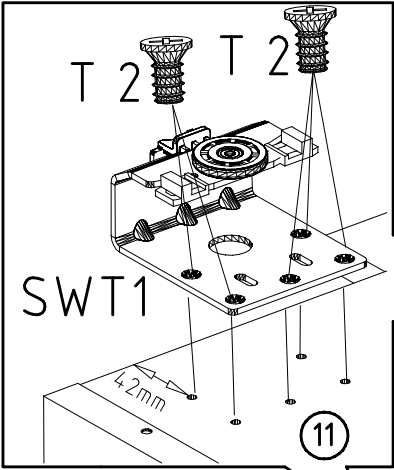
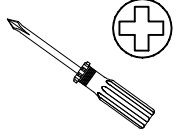

4

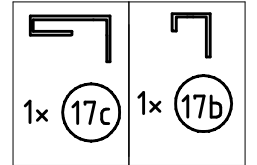
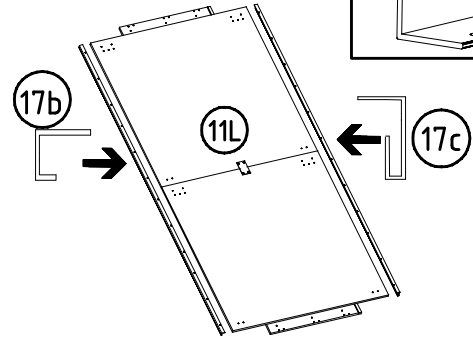
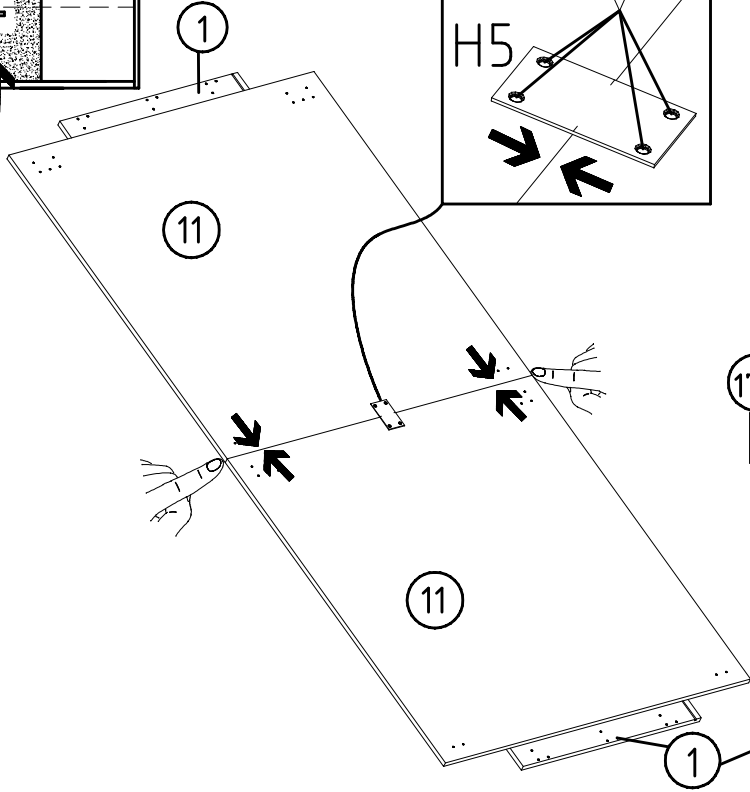
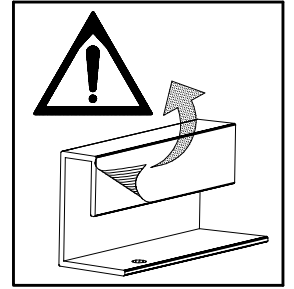
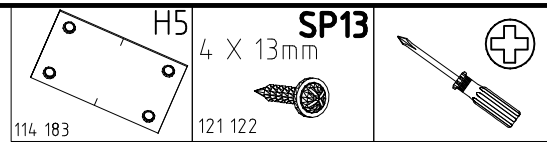
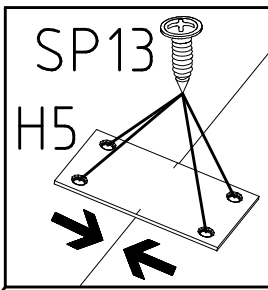
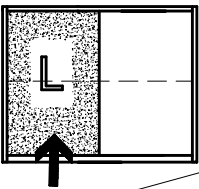

5

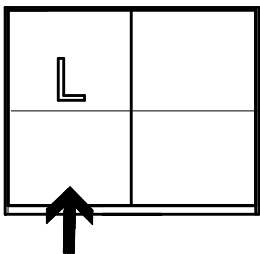
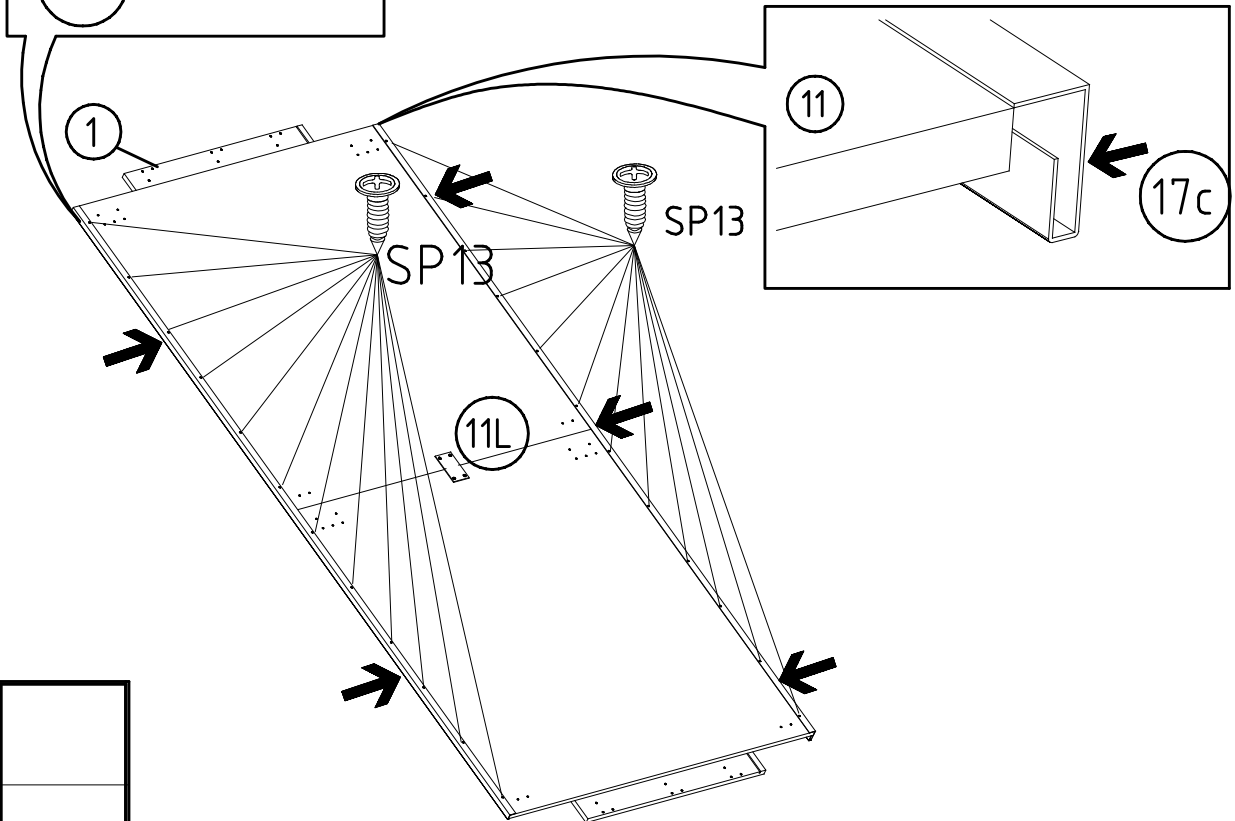
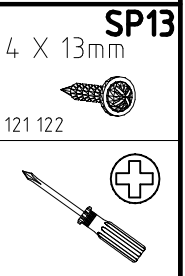
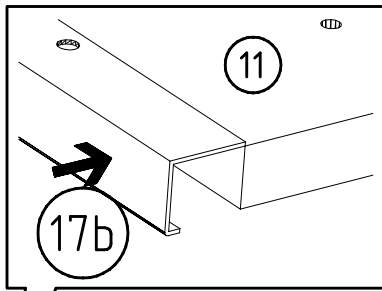

6

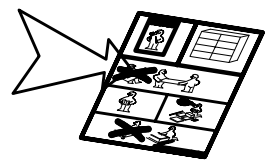
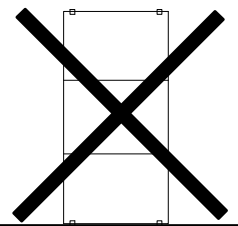
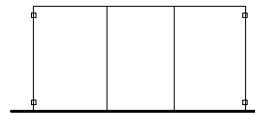
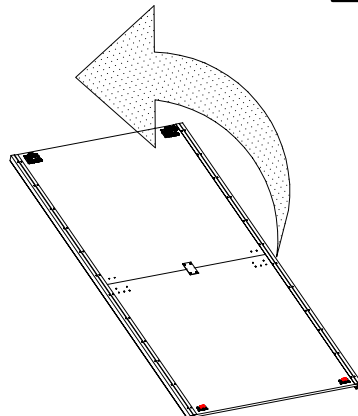
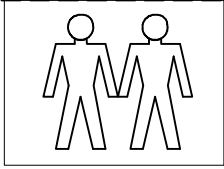
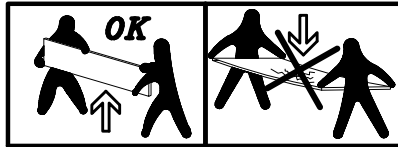
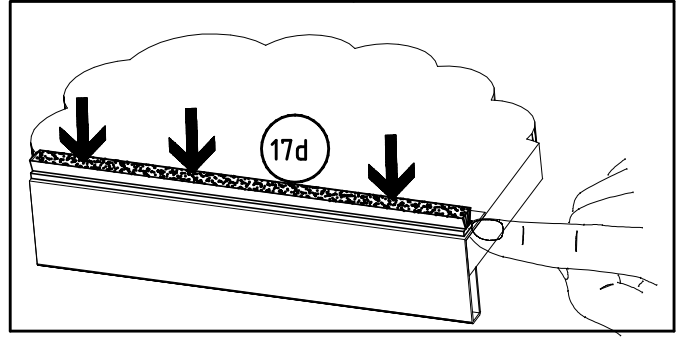
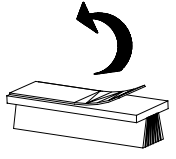
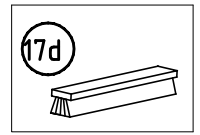
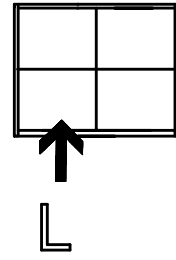
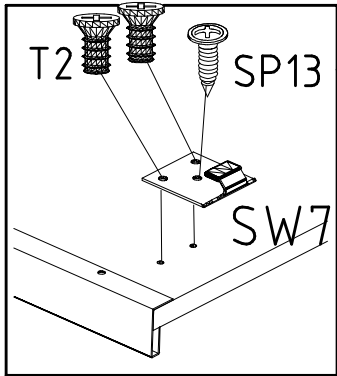
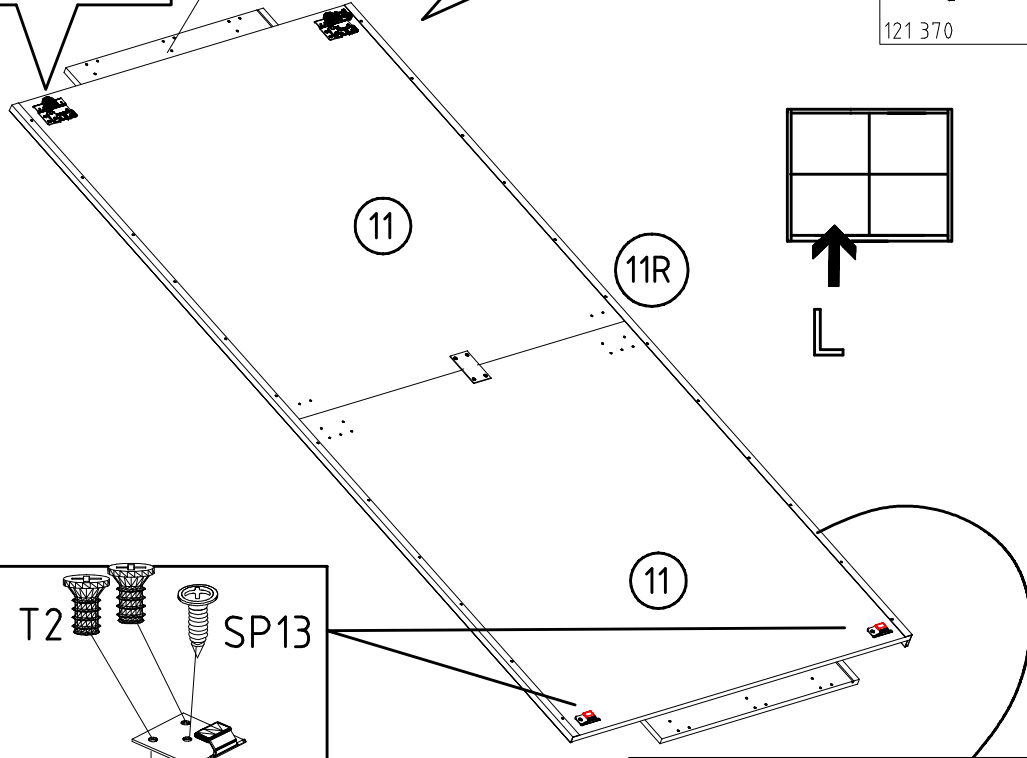
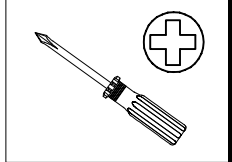
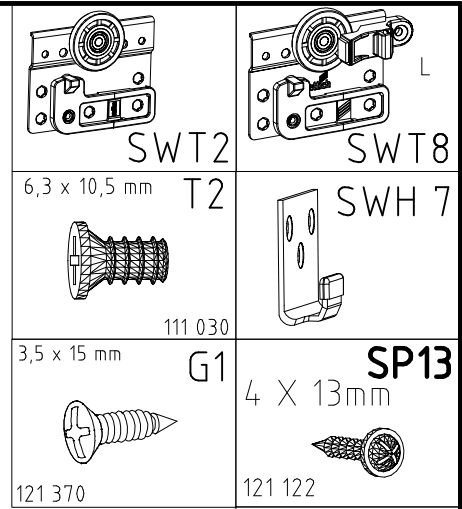
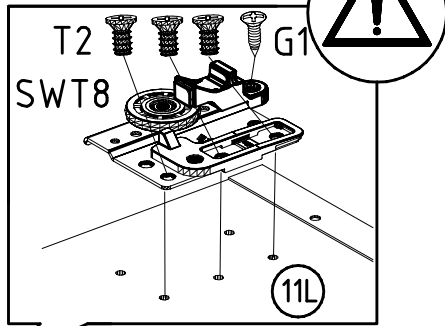
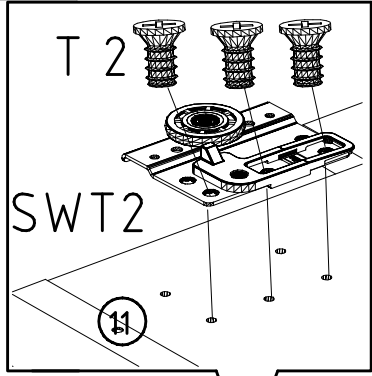

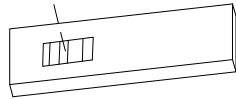
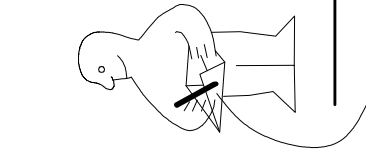
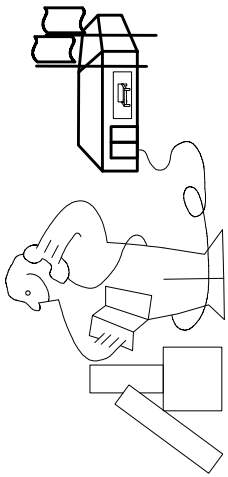
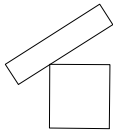
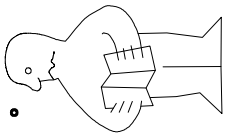

Modell/Model/Modèle



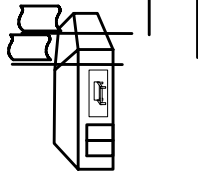

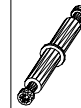
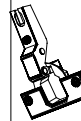
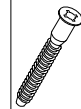

{121 370}	{ G 1 }	{4x}

Änderungen die dem technischen Fortschritt geschuldet sind, behalten wir uns vor!
 Bei nicht vorschriftsmäßiger und/ oder nicht fachmännischer Montage wird bei Personen- und/ oder Sachschäden keinerlei Haftung übernommen.

WIMEX Wohnbedarf/ Import Export Handels GmbH/ Postfach 1407/ 49112 Georgsmarienhütte/ Germany
 Tel.:(+49) 054-01 8598 16/17 Fax.:(+49) 054-01 8598 33 Mail: service_H@wimex-online.com

104P-NR. / 104P-NO. 150X-NR. / 150X-NO. Auftrag/Order-No. / No. de Commande

23203 **30110XY** 104

Kunde MAX MUSTERMANN
Customer
Client

Kommission / your order reference / votre reference

3377 MINDEN

Dekor / Decor Decor / Modell / Modele

F99 **SAMPLE**

F99842 SCHWEBETUERENSCHRANK 250 CM H 216CM
PLANKENEICHE NB + RAH STEEL
PLANKENEICHE NACHBILDUNG

202320301107241476000001

Paket / Package / Paquet

414760

SOCKEL

Paket 1 von 8 Colli Kommission 10

HSP-SMT BOD 50 TEXT/TEX SOCKEL 32 FRESH TV / LF 104
SO-BOD TEXT RASTEX/ ZNBOD D18MM TX KLSTA

Montage - Anleitung Laenge 520,0 OBEREN
KS-64 Breite 568,0 OBEREN

SOCKEL32 KLEB

En cas de dommage, veuillez retourner le carton avec le produit. / En cas de dommage, veuillez retourner le carton avec le produit.



OBEREN 5 30/19 HAUT 23.08.19 OBEREN 1 1. ABOVE OBEREN



WIMEX Wohnbedarf
Import Export Handelsges mbH & Co. KG
Werner-von-Siemens-Str. 35
D-49124 Georgsmarienhütte - Germany

SAMPLE **23.08.19**
Modellname Produktionsdatum
Model Date of manufacture

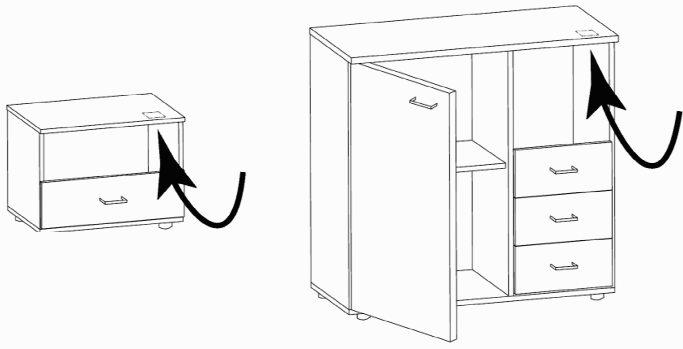
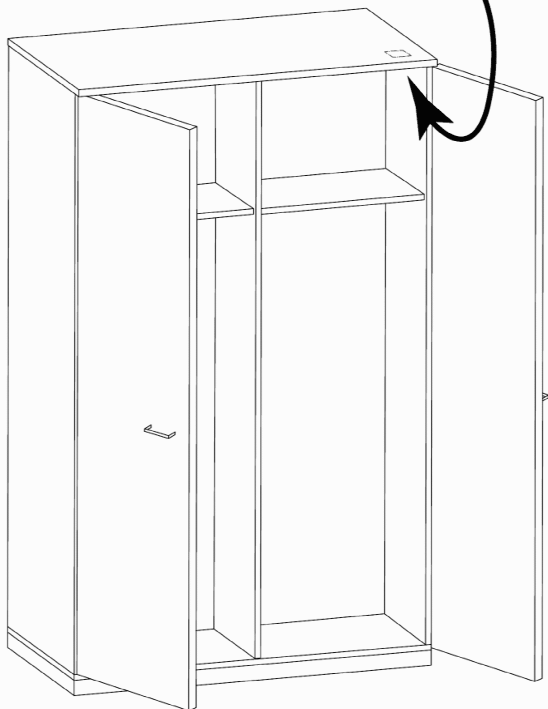
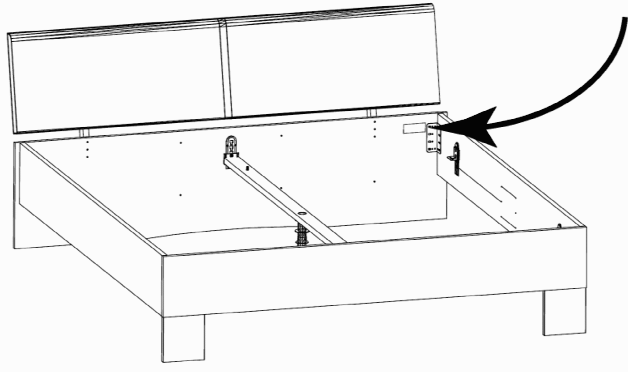

980801

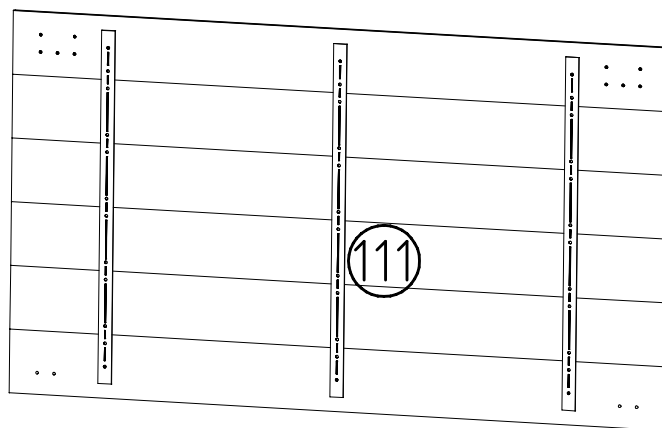
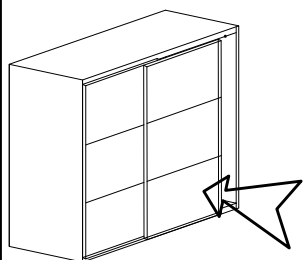
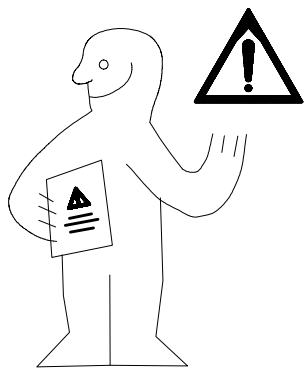

111

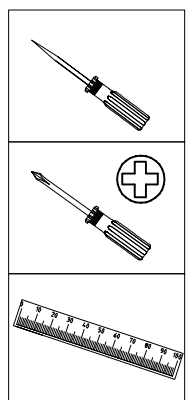

1x 990/1235/1485 x 118/128 x 15 (111o)

1x 990/1235/1485 x 118/128 x 15

4x 990/1235/1485 x 118/128 x 15 (111m)

4x 990/1235/1485 x 118/128 x 15

1x 990/1235/1485 x 118/128 x 15 (111u)

1x 990/1235/1485 x 118/128 x 15

3x 654 x 25 x 2 (112)

3x 654 x 25 x 2

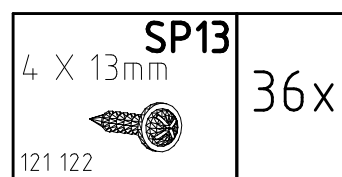

1

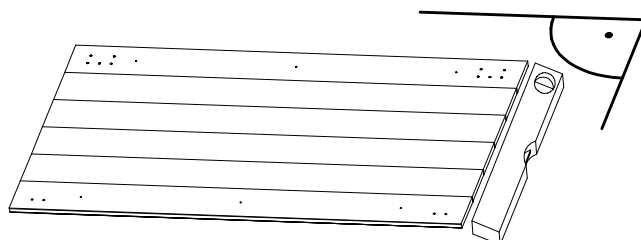
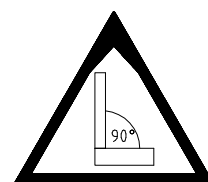
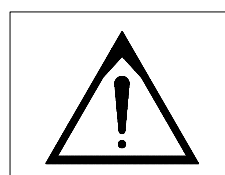
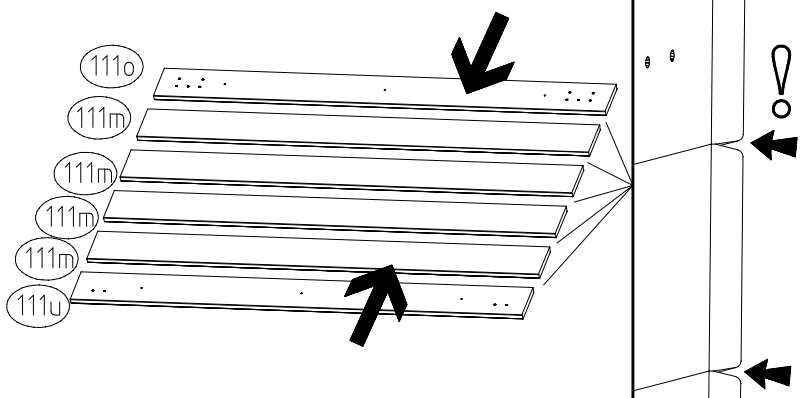

2

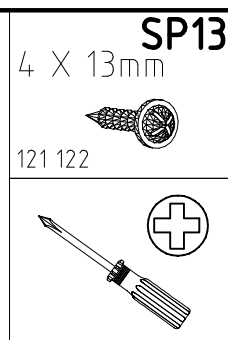
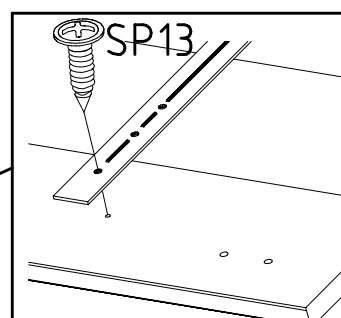
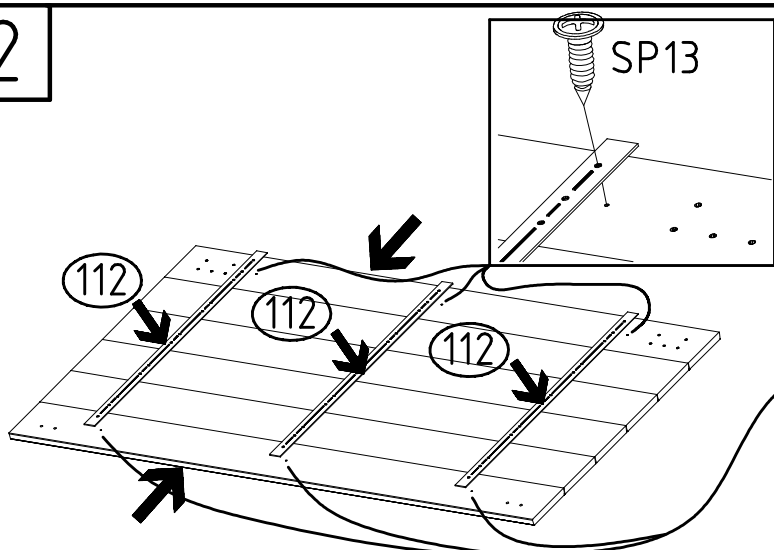

980801

02.05.18 / 01.06.18

06 18

1/2

3

SP13

4 X 13mm

121 122

