

# TEAM7

Dokument für  
die qualifizierte  
Fachkraft!



## Montageanleitung

# Essen

## miró Auszugtisch

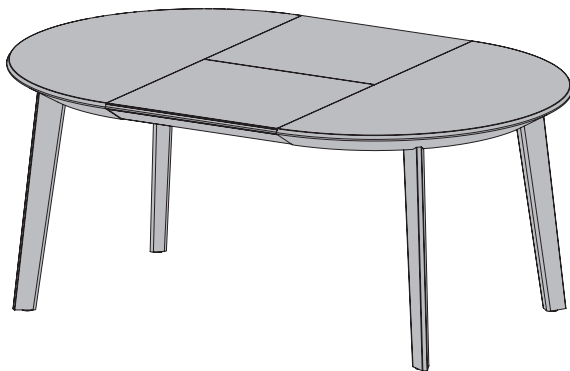
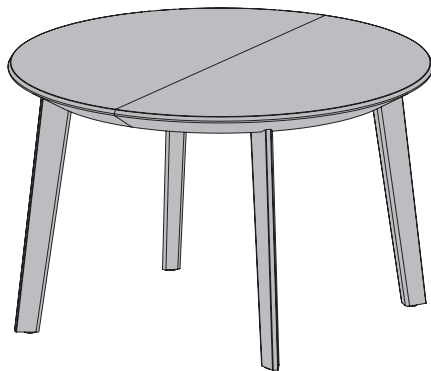

**DE**

112021  
TD180905A

Nach der Montage  
zur Aufbewahrung für  
unsere Kunden!

## ! RAUMKLIMA

- Ideales Raumklima für Menschen, Pflanzen und Naturholzmöbel ist:

**rel. Luftfeuchtigkeit: 40 bis 60% und eine  
Raumtemperatur: 18° bis 23° Celsius.**

- Bei längeren Über- bzw. Unterschreitungen dieser Werte kommt es zu Schwind- bzw. Quellvorgängen. In Folge können Verzug, Risse, offene Leimfugen und raue Oberflächen auftreten.

## ! PFLEGE

- Pflegeanleitungen (Naturholz-, Leder-, Stoff-, Stricktex-, Stein-, Glas-, Filz-, Keramik-, Metall-, und Arbeitsplattenpflege) entnehmen Sie bitte der TEAM 7 Homepage.
- Wichtige produkt- und warentypische Eigenschaften der TEAM 7 Naturholzmöbel finden Sie auch in unserem Service- und Gütepass unter:

<https://www.team7-home.com/at/de/service/service-und-guetepass/>



## ! DOKUMENTATION

- Bewahren Sie alle Unterlagen zum Kauf Ihres Möbelstücks, auch über die gesetzliche Gewährleistungspflicht von zwei Jahren, sorgsam auf.
- Wenn Sie Ersatz- oder Ergänzungsteile benötigen, erleichtern Ihnen die Kaufunterlagen die genaue Auskunft über das von Ihnen erworbene Produkt.
- Bei Transportschäden Ihres Möbelstücks, sind Fotos des beschädigten Teils in der Originalverpackung zwingend notwendig.

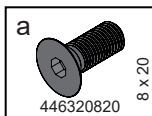
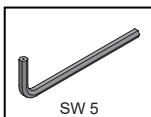

## 1. Tischplatte auf Unterlage auflegen

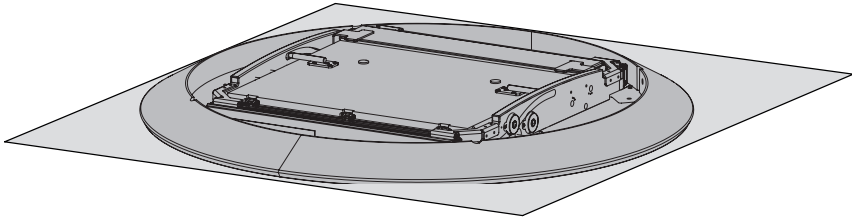

### HINWEIS

- Unterlage verwenden!
- Die Unterlage muss frei von spitzen oder scharfkantigen Gegenständen sein.

## 2. Tischverriegelung lösen

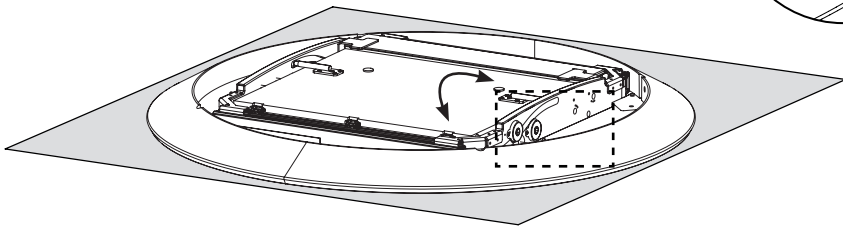
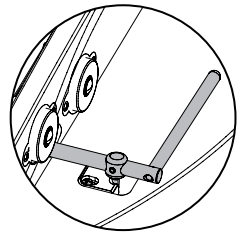

Hebel bis zum Anschlag drehen

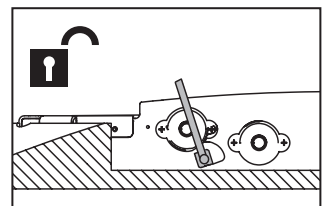
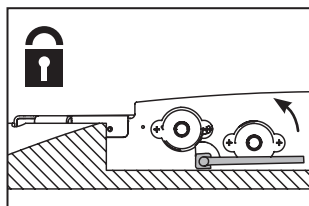

### 3. Tisch ausziehen

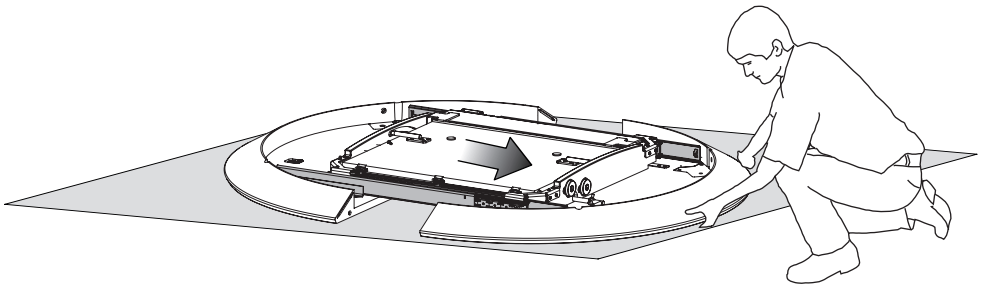

#### HINWEIS

- Auszug nur wenige Zentimeter ausziehen.

### 4. TischfüÙe montieren

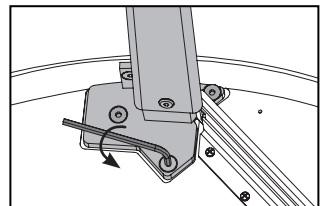
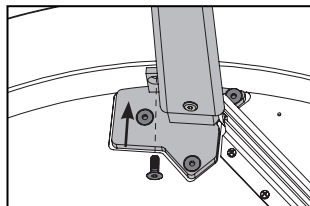
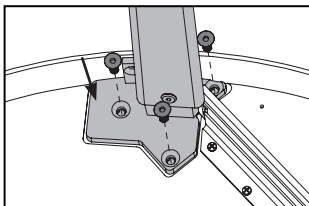
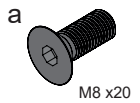
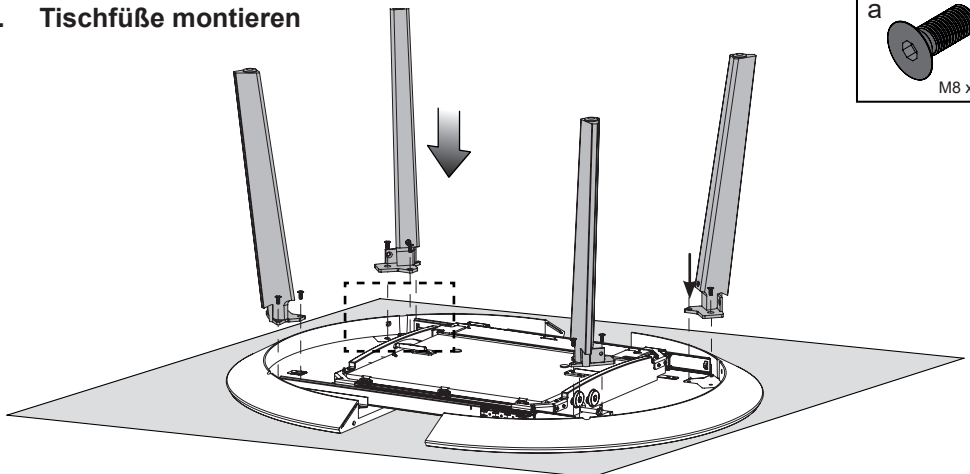

## 5. Tischauszug zusammenschieben und danach verriegeln

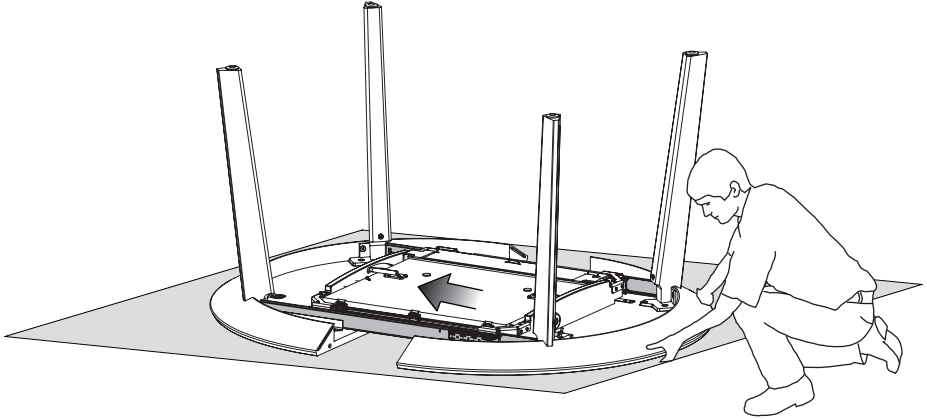

Hebel bis zum Anschlag drehen

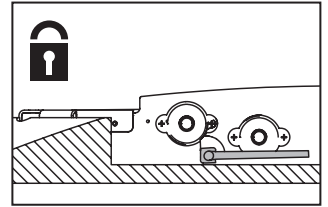
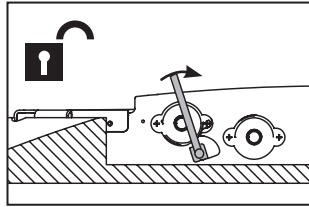

## 6. Tisch bewegen

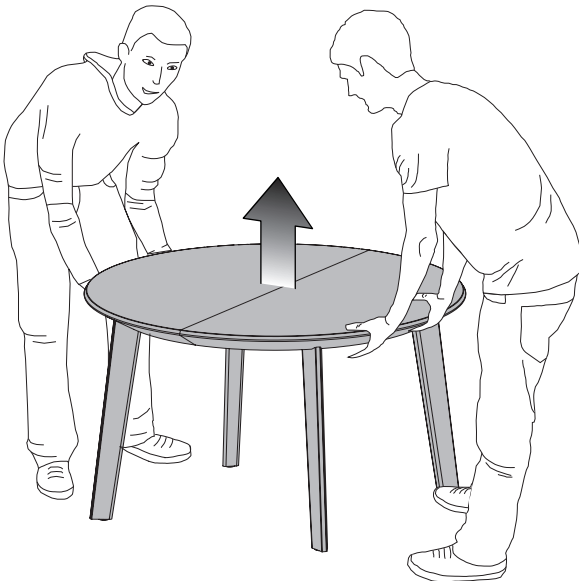

### **⚠ HINWEIS**

- Beim Anheben und Tragen auf rückschonende Trageweise achten.
- Bei einem Positionswechsel den Tisch immer anheben.
- Der zusammengebaute Tisch darf nur im geschlossenen und verriegelten Zustand gehoben und transportiert werden.

## 7. Tischverriegelung lösen

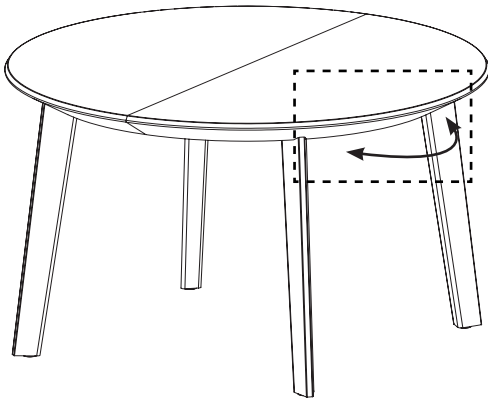

Hebel bis zum Anschlag drehen

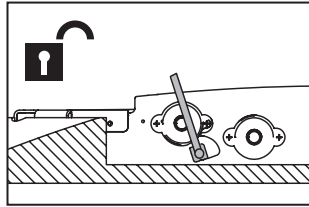
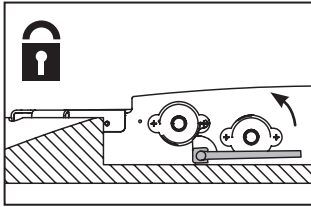

## 8. Tisch ausziehen



### HINWEIS

- Auszug immer bis zum Endanschlag ausziehen.

## 9. Tischeinlegeplatte ausklappen

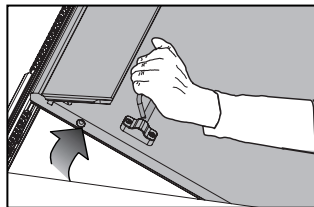
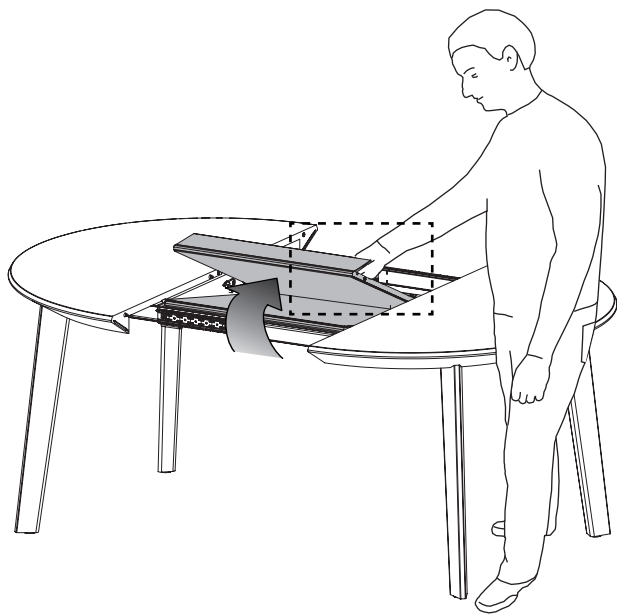

## 10. Tisch zusammenschieben

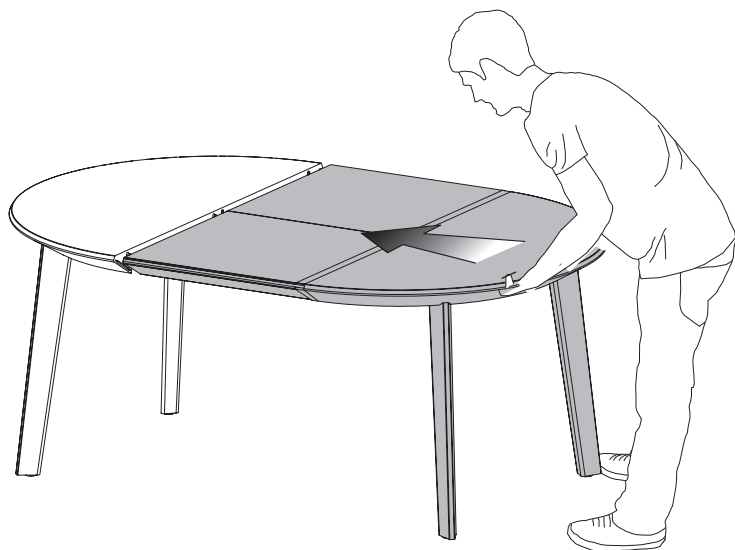

## 11. Tisch verriegeln

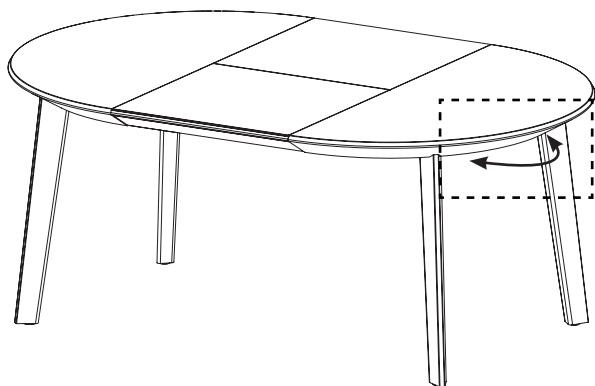

Hebel bis zum Anschlag drehen

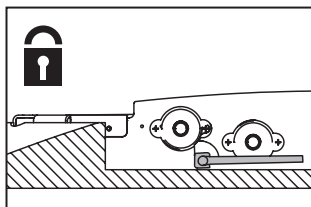
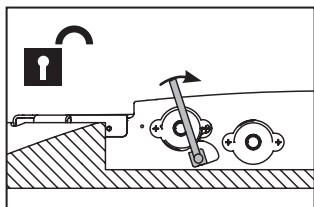

# TEAM 7

**TEAM 7 Natürlich Wohnen GmbH**

Braunauer Str. 26

4910 Ried im Innkreis, AUSTRIA

**Montagehotline: +43/7752-977321**

[www.team7-home.com](http://www.team7-home.com)

Änderungen, Irrtümer, Druck- und Satzfehler vorbehalten

Urheberrecht

Das Werk einschließlich aller Teile ist urheberrechtlich geschützt. Jede Verwertung außerhalb der engen Grenzen des Urheberrechtsgesetzes ist ohne Zustimmung der Firma TEAM 7 GmbH unzulässig und strafbar. Das gilt insbesondere für Vervielfältigung, Mikroverfilmung und die Einspeicherung und Verarbeitung in elektrische Systeme.



# TEAM7



Instructions de montage

# Les repas

## miró Table à rallonge

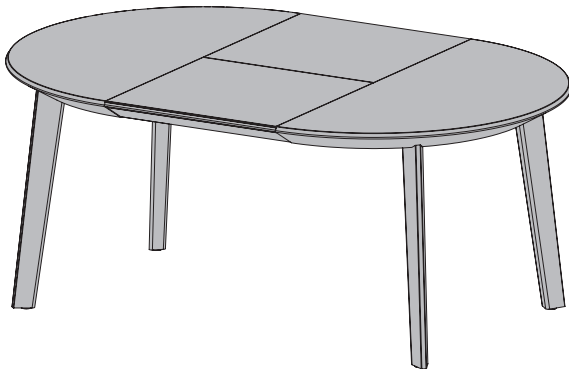
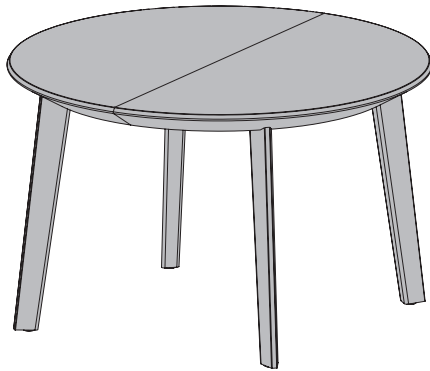

**FR**

## ⚠ CLIMAT INTERIEUR

- Climat intérieur idéal pour les personnes, les plantes et les meubles en bois naturel :

**une humidité relative comprise entre 40 et 60 % et  
Température ambiante : de 18 à 23 °C.**

- Le dépassement supérieur et/ou inférieur prolongé de ces valeurs entraîne une rétraction ou un gonflement de ce matériau. Risque de déformation, fissure, joint décollé et surface rugueuse.

## ⚠ ENTRETIEN

- Les consignes d'entretien sont disponibles sur le site Internet TEAM 7 (entretien du bois naturel, du cuir, de l'étoffe, du Stricktex, de la pierre, du verre, métal, céramique du feutre et des plans de travail)
- Vous trouverez d'importantes caractéristiques des meubles en bois naturel TEAM 7 également dans le certificat de service et de qualité à l'adresse suivante :

<https://www.team7-home.com/at/de/service/service-und-guetepass/>



## ⚠ DOCUMENTATION

- Veuillez conserver soigneusement tous les documents d'achat de votre meuble, même au-delà de la garantie légale de deux ans.
- S'il vous faut des pièces de rechange ou des accessoires, tous les renseignements concernant le produit que vous aurez acheté figurent sur ces documents.
- Si votre meuble a été endommagé durant le transport, joindre impérativement des photos de la partie endommagée dans l'emballage d'origine.

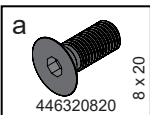
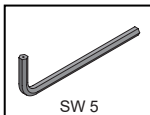

## 1. Poser le plateau de table sur le support

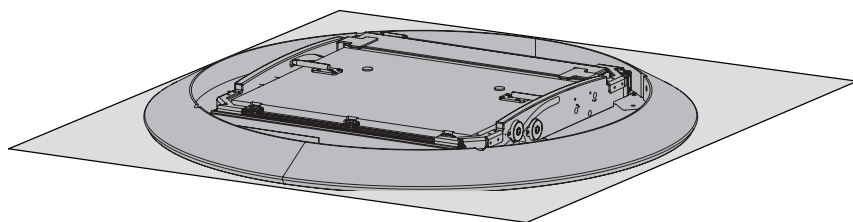

### REMARQUE

- Mettre une protection.
- Le support doit être libre d'objets pointus ou présentant des arêtes vives.

## 2. Déverrouiller la table

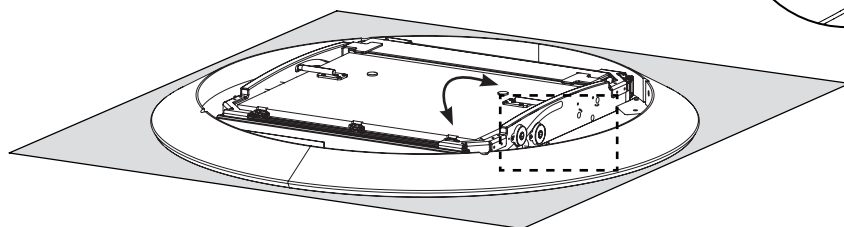
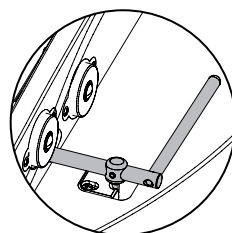

Tourner le levier jusqu'à la butée

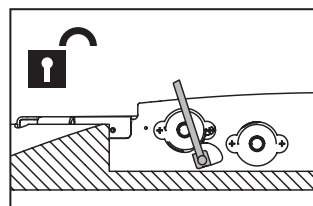
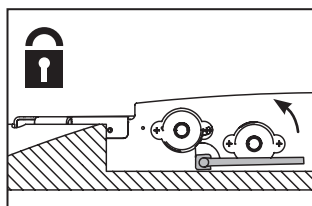

### 3. Tirer la table

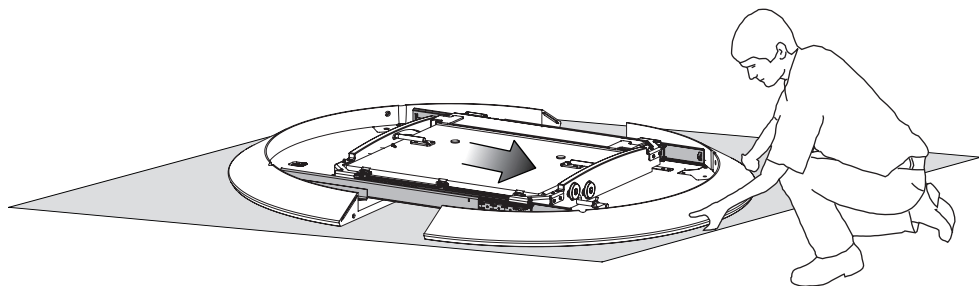

#### REMARQUE

- Ne sortir la rallonge que de quelques centimètres.

### 4. Monter les pieds de table

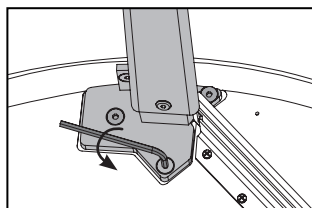
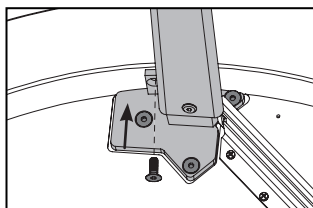
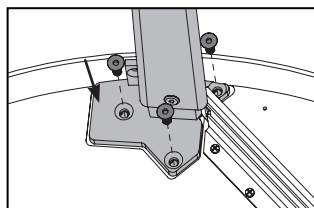
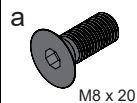
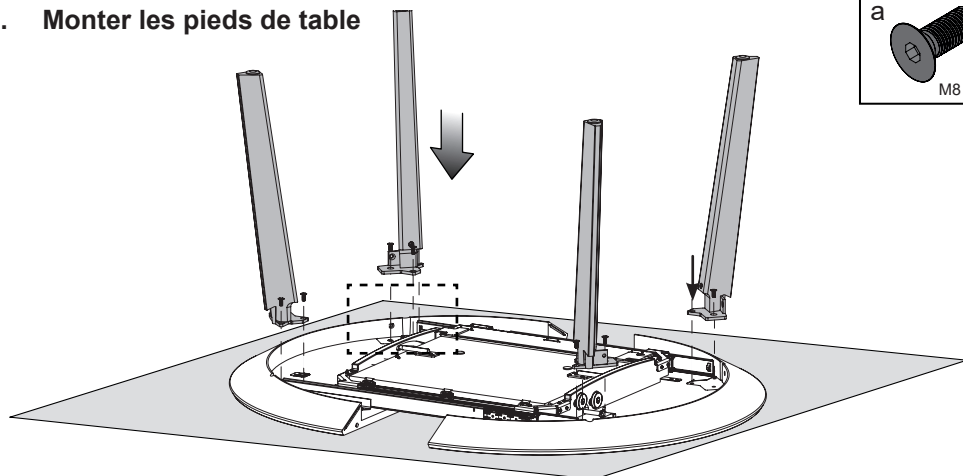

## 5. Repousser la rallonge puis verrouiller

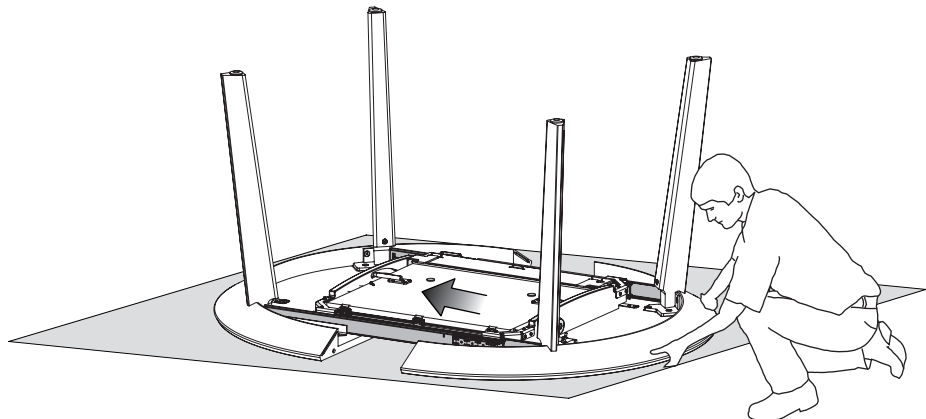

Tourner le levier jusqu'à la butée

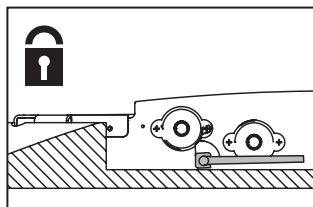
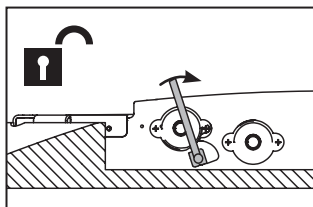

## 6. Bouger la table

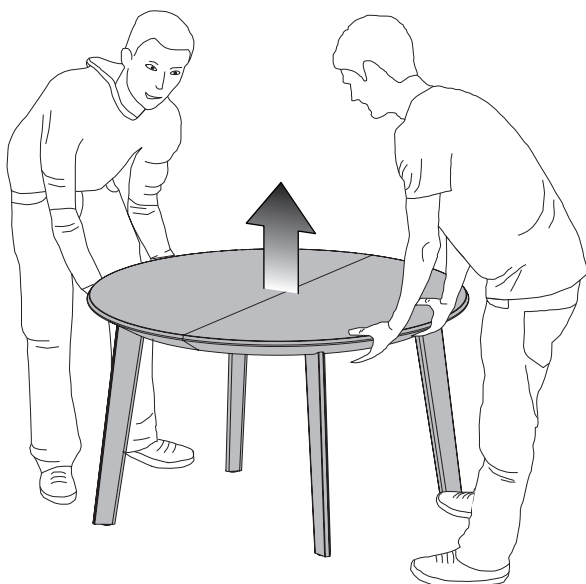

### **REMARQUE**

- Soulever et porter en préservant le dos.
- La table doit toujours être soulevée lors d'un changement de position.
- Avant de la soulever et de la transporter, il faut fermer et verrouiller la table assemblée.

## 7. Déverrouiller la table

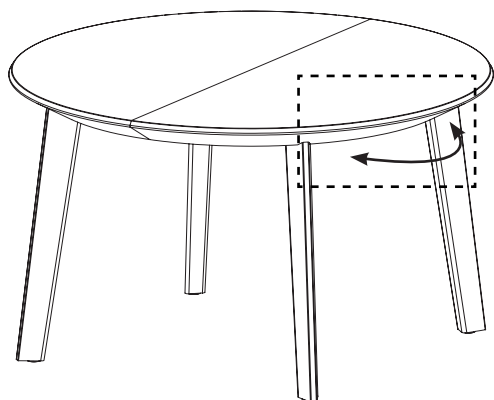

Tourner le levier jusqu'à la butée

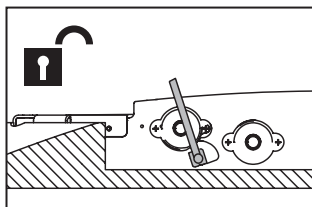
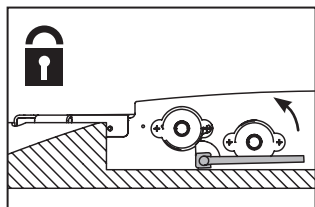

## 8. Tirer la table

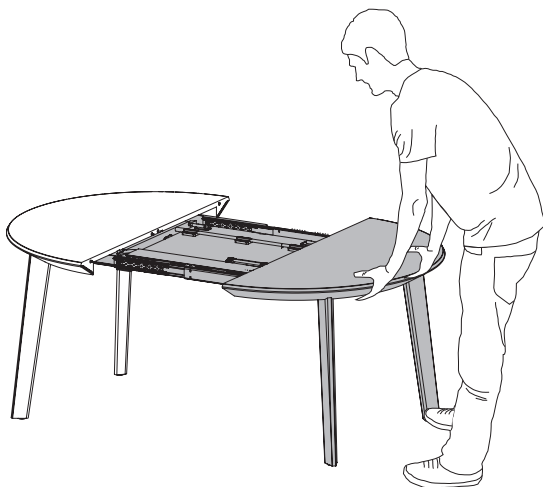

### REMARQUE

- Tirer toujours la coulisse jusqu'à la butée.

## 9. Déployer rallonge

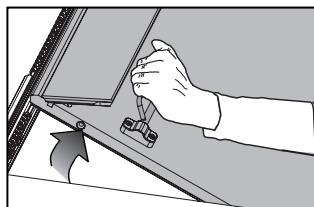
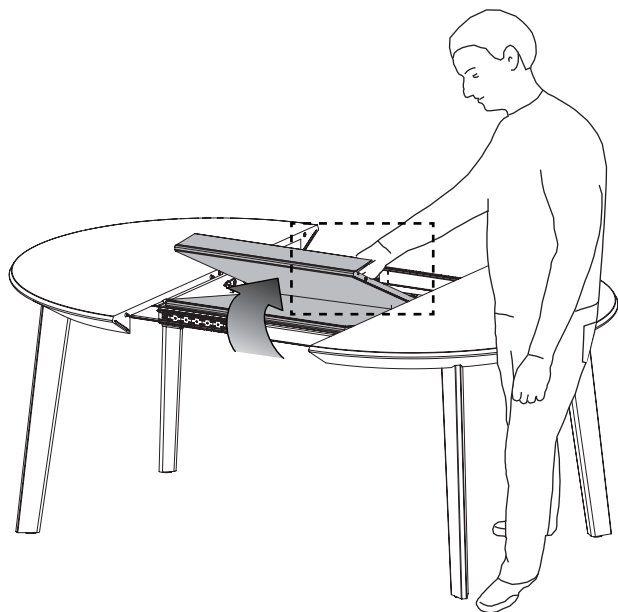

## 10. Rapprocher les plateaux de table

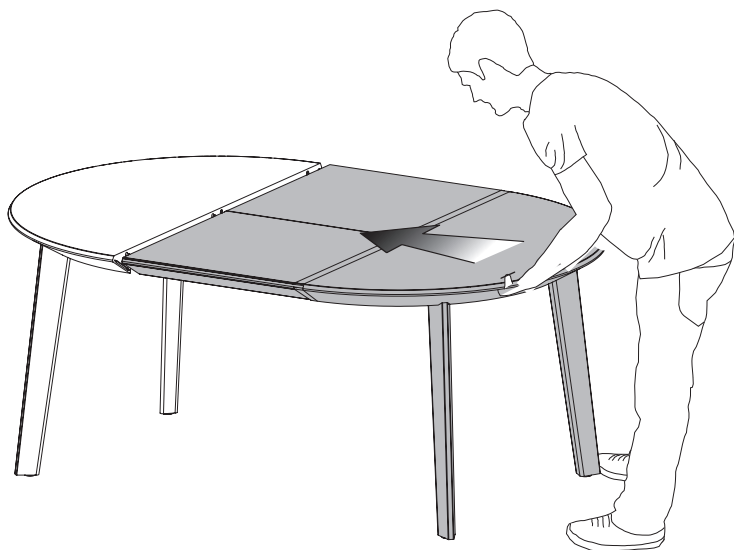

## 11. Verrouiller la table

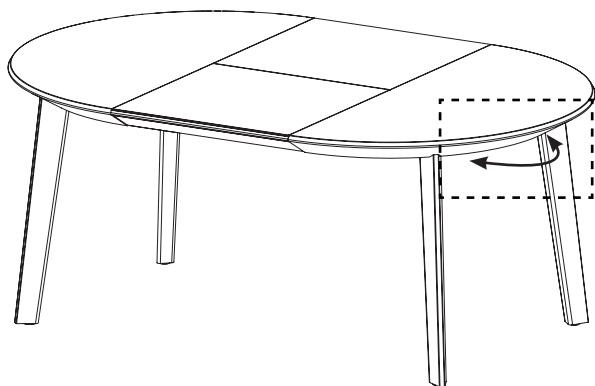

Tourner le levier jusqu'à la butée

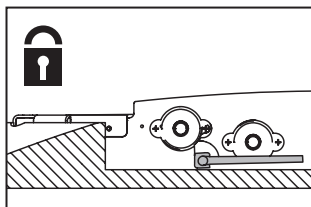
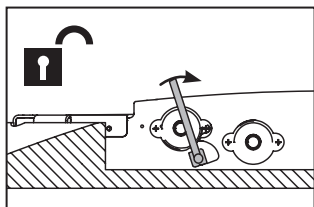

# TEAM 7

**TEAM 7 Natürlich Wohnen GmbH**

Braunauer Str. 26

4910 Ried im Innkreis, AUSTRIA

**Installation Hotline: +43/7752-977321**

[www.team7-home.com](http://www.team7-home.com)

Sous réserve de modification, d'erreur et de coquille

Droit d'auteur

L'œuvre et toutes ses parties sont protégées par le droit d'auteur. Toute utilisation, en dehors des limites strictes prévues par la loi sur le droit d'auteur, faite sans le consentement de l'entreprise TEAM 7 GmbH, est illicite et passible de poursuites judiciaires. Ladite clause s'applique notamment à la reproduction, au microfilmage, ainsi qu'à la sauvegarde et au traitement par voie électronique.



# TEAM7

Documento per il  
personale qualifi-  
cato!



## Istruzioni per il montaggio

# Pranzo

## miró Tavolo allungabile

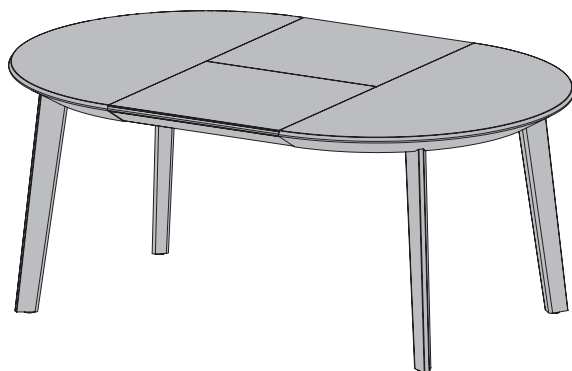
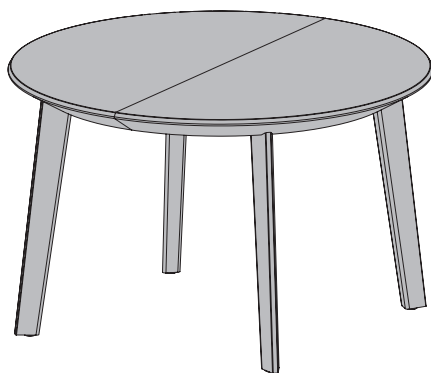

# IT

112021  
TD180905A

Dopo il montaggio da  
conservare per i nostri  
clienti!

## CLIMA DELL'AMBIENTE

- Il clima ambiente ideale per persone, piante e mobili in legno naturale è:

**Umidità atmosferica rel. 40 - 60% e una  
Temperatura ambiente: fra 18 e 23° Celsius.**

- In caso di superamento in eccesso o in difetto di questi valori per lungo tempo, si verificano ritiri o rigonfiamenti. In seguito possono verificarsi svirgolamento, crepe, scollamento di fughe e irruvidimento delle superfici.

## MANUTENZIONE

- Per le istruzioni di manutenzione (cura di pannelli in legno naturale, pelle, stoffa, Stricktex, pietra, vetro, Metallo, ceramica feltro e piani di lavoro) consultare il sito web di TEAM 7.
- Troverete importanti caratteristiche dei mobili in legno naturale TEAM 7 anche nel nostro pass assistenza e qualità qui:

<https://www.team7-home.com/at/de/service/service-und-guetepass/>



## DOCUMENTAZIONE

- Conservare accuratamente tutta la documentazione relativa all'acquisto di questo mobile, anche oltre la garanzia di due anni obbligatoria per legge.
- Quando si richiedono parti di ricambio o di integrazione, la documentazione d'acquisto facilita la ricerca di informazioni precise sul prodotto acquistato.
- In caso di danni ai mobili causati dal trasporto, è assolutamente necessario produrre foto della parte danneggiata nell'imballaggio originale.

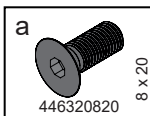
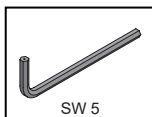

## 1. Posare il tavolo sulla base

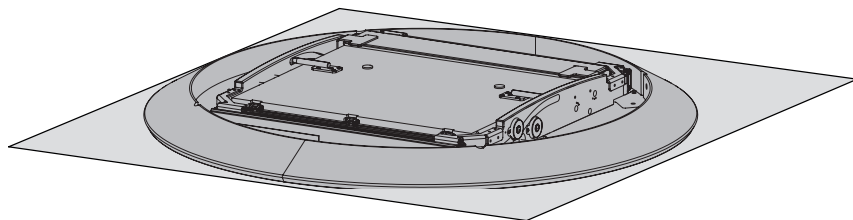

### AVVERTENZA

- Non appoggiare il piano del tavolo.
- La base deve essere libera da oggetti appuntiti o taglienti.

## 2. Sbloccare il blocco del tavolo

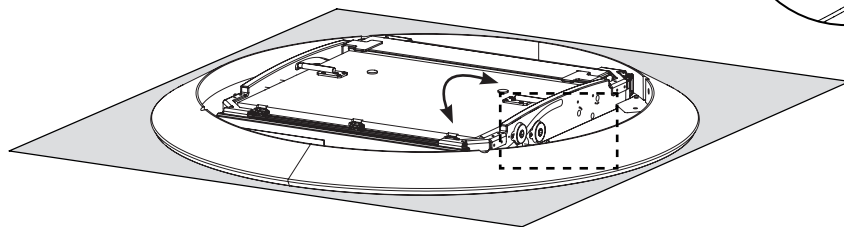
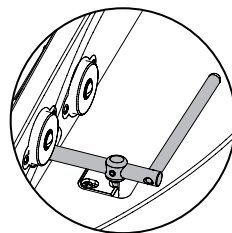

Ruotare la leva fino all'arresto

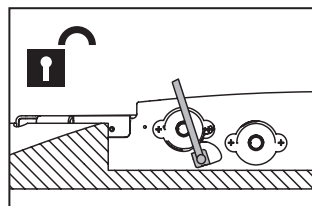
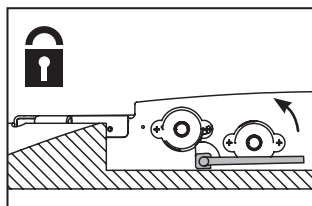

### 3. Estrarre il tavolo

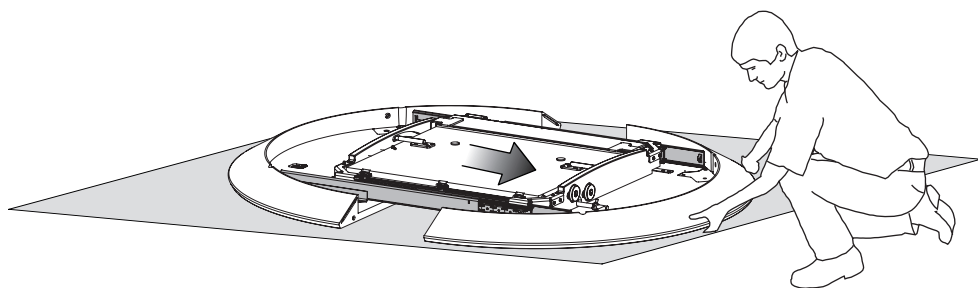

#### **AVVERTENZA**

- Estrarre la prolunga solo di pochi centimetri.

### 4. Montare i piedi del tavolo

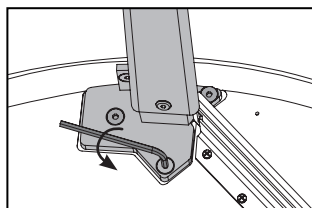
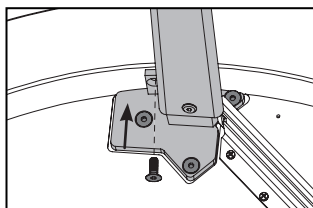
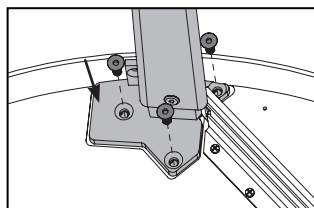
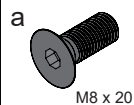
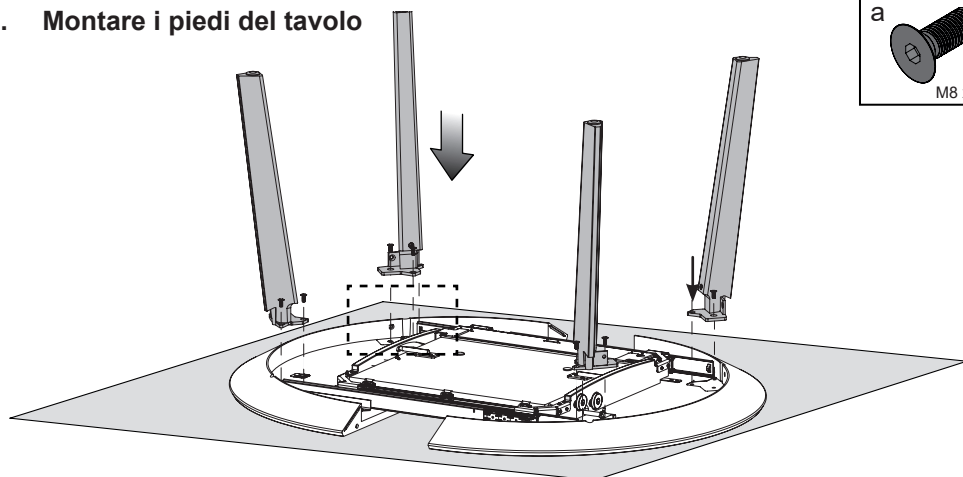

## 5. Chiudere e bloccare la prolunga del tavolo.

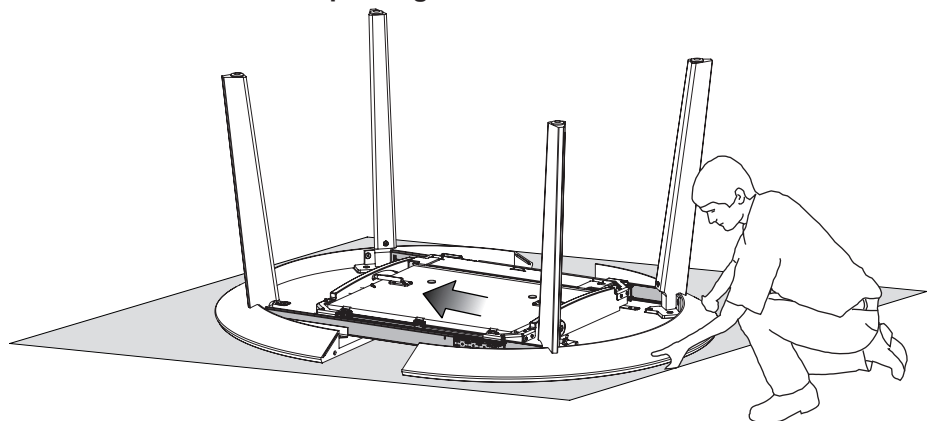

Ruotare la leva fino all'arresto

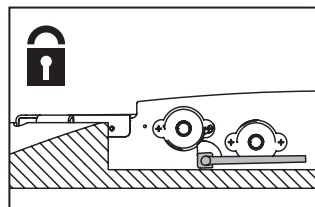
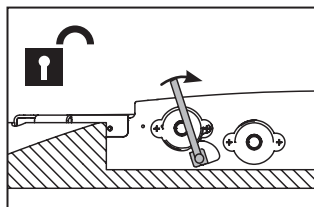

## 6. Muovere tavolo

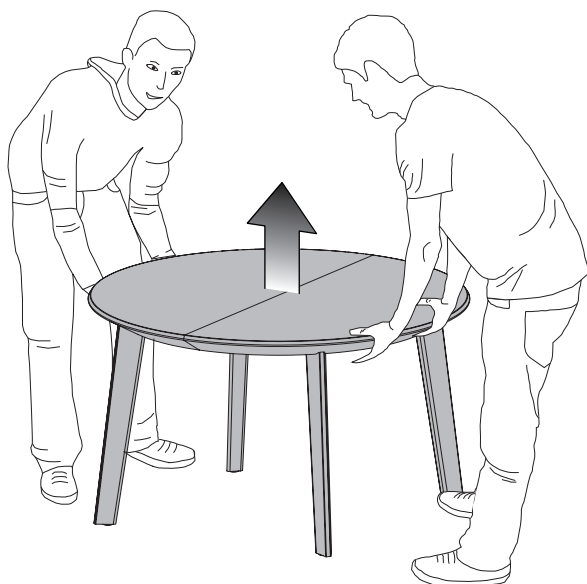

### **⚠ AVVERTENZA**

- Attenzione alla schiena durante il sollevamento e il trasporto.
- Per cambiare posizione, sollevare sempre il tavolo.
- Il tavolo assemblato può essere sollevato e trasportato solo se chiuso e bloccato.

## 7. Sbloccare il blocco del tavolo

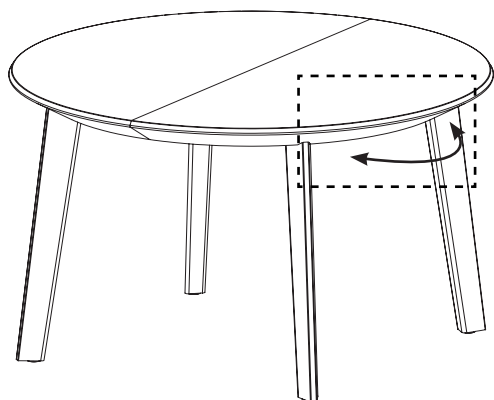

Ruotare la leva fino all'arresto

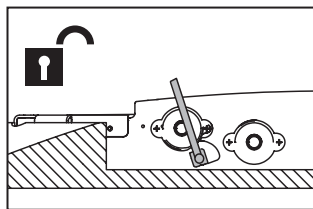
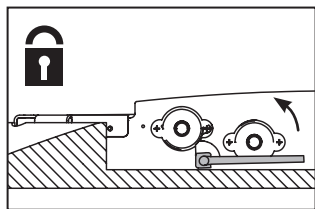

## 8. Estrarre il tavolo

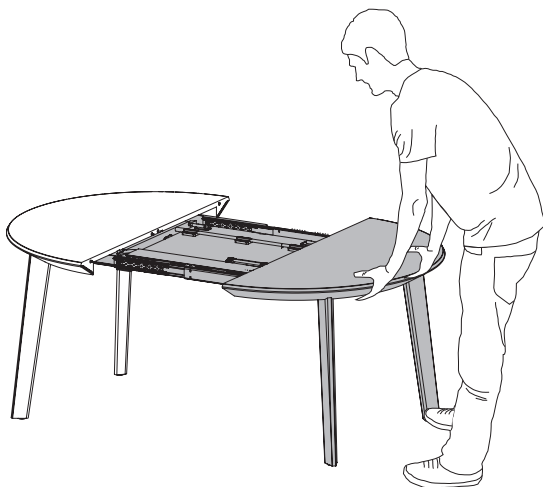

### **AVVERTENZA**

- Tirare fuori l'estraibile sempre fino al fermo.

## 9. Aprire la prolunga del tavolo

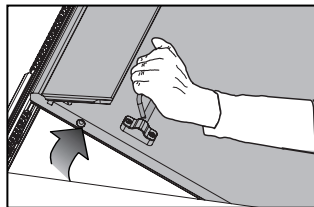
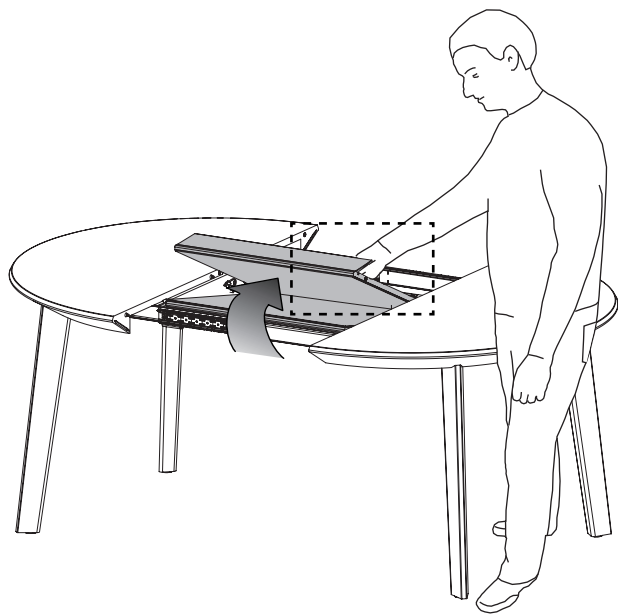

## 10. Accostare gli elementi del tavolo

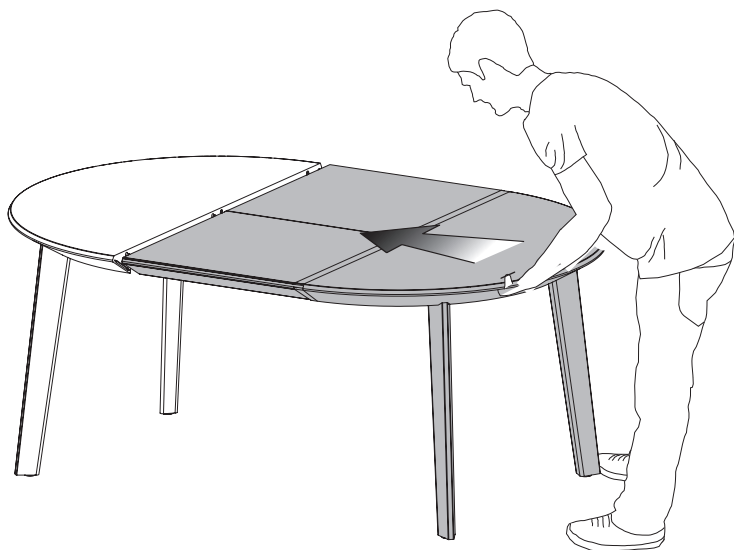

## 11. Bloccare il tavolo

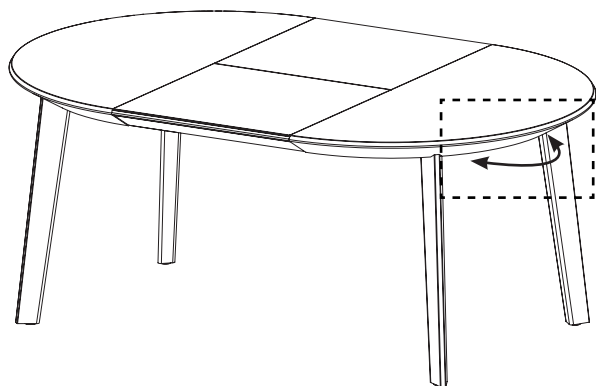

Ruotare la leva fino all'arresto

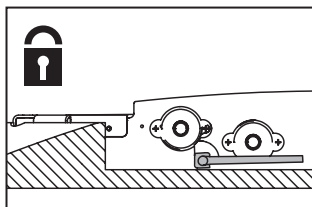
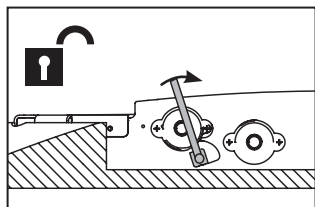

# TEAM 7

**TEAM 7 Natürlich Wohnen GmbH**

Braunauer Str. 26

4910 Ried im Innkreis, AUSTRIA

**Hotline installazione: +43/7752-977321**

[www.team7-home.com](http://www.team7-home.com)

Con riserva di modifiche, errori, errori di stampa e impaginazione

Diritto d'autore

La pubblicazione è tutelata da diritto d'autore in tutte le sue componenti.

Qualsiasi utilizzo che esuli dagli stretti limiti imposti dalla legge sul diritto d'autore è vietato e perseguibile ai fini di legge senza l'approvazione della ditta TEAM 7 GmbH. Questo vale in particolare per la copia, la riproduzione con microfilm e la memorizzazione ed elaborazione in sistemi elettrici.



# TEAM7

Document for qualified specialist!



## Assembly Instruction

# Dining

## miró extendable table

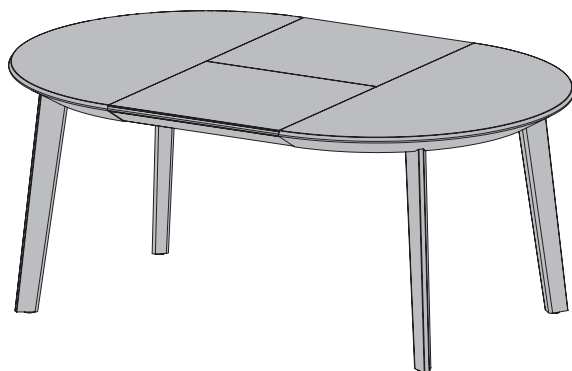
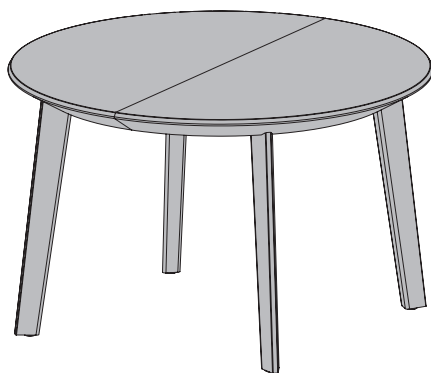

**GB**

112021  
TD180905A

After installation, keep  
in a safe place for our  
customers!

## ! INDOOR CLIMATE

- Ideal indoor climate for human beings, plants and furniture made of natural wood is:

**rel. humidity: 40 to 60% and a  
Room temperature: 18° to 23° Celsius.**

- If these levels are exceeded or not reached for any prolonged period, swelling or shrinkage will occur. This may result in warping, cracking and rough surfaces.

## ! CARE

- Care instructions (care of natural wood, leather, fabric, Stricktex, stone, glass, felt, metal, ceramics and worktops) can be found on the TEAM 7 website.

- Major typical product properties of natural wood furniture from TEAM 7 can also be found in our service and quality certificate on:

<https://www.team7-home.com/at/de/service/service-und-guetepass/>



## ! DOCUMENTATION

- Keep all documents relating to the purchase of your item of furniture in a safe place, also beyond the statutory warranty period of two years.
- If you need replacement or additional parts, please refer to the purchase documentation as this will give you exact information on the product you have purchased and make the process easier.
- If your item of furniture is damaged in transit, it is imperative that you provide photographs of the damaged part while it is still in the original packaging.

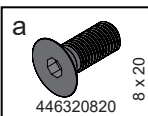
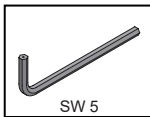

## 1. Position table top on base

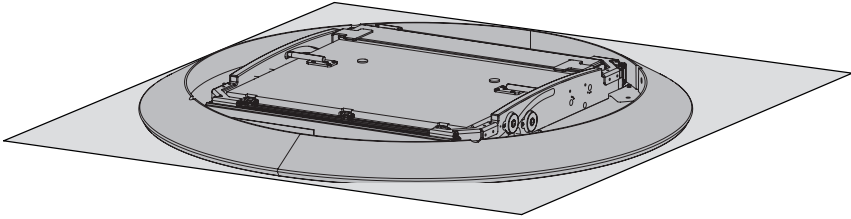

### NOTICE

- assemble on a mat or
- The base must be free from pointed or sharp-edged objects.

## 2. Undo table lock

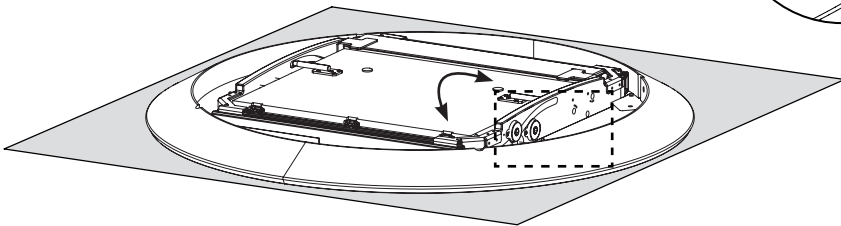
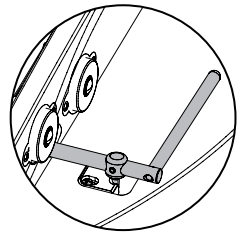

Turn lever as far as it will go

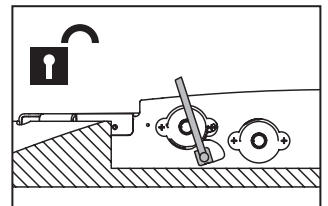
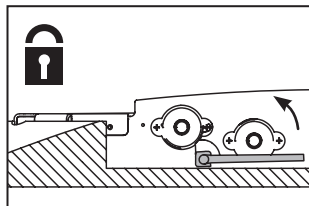

### 3. Extend table

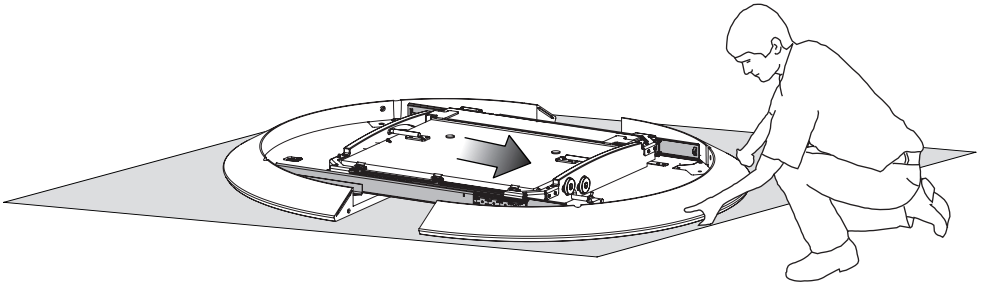

#### NOTICE

- Only extend by a few centimeters.

### 4. Mount table legs

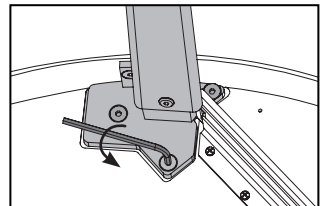
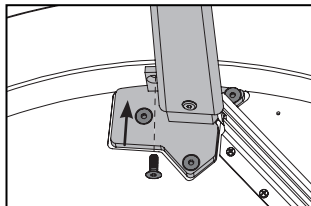
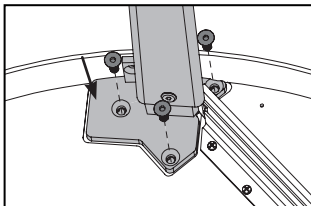
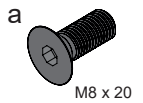
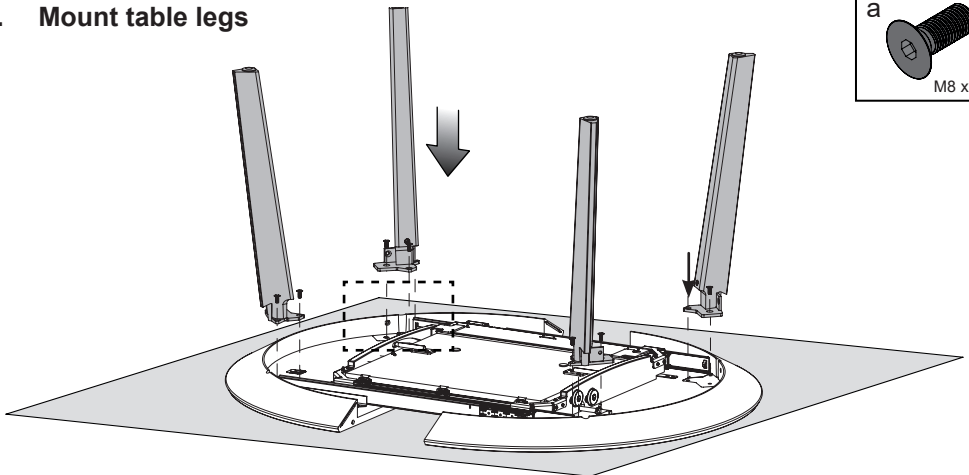

## 5. Push table extension leaf together and then lock in place

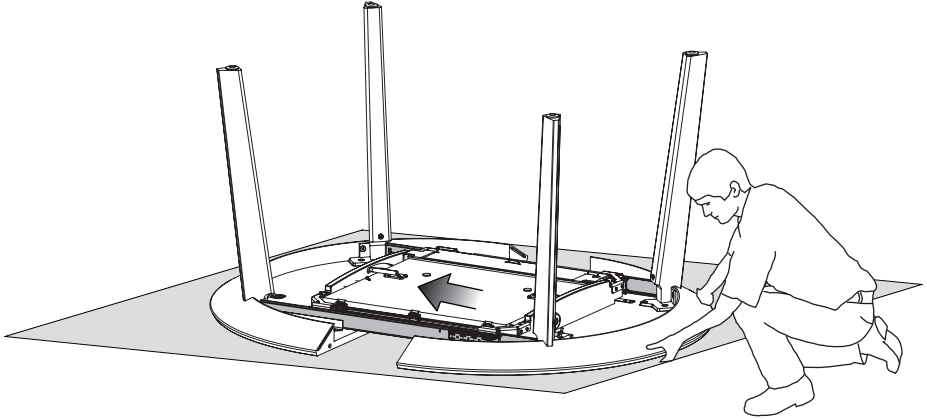

Turn lever as far as it will go

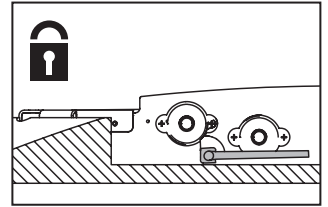
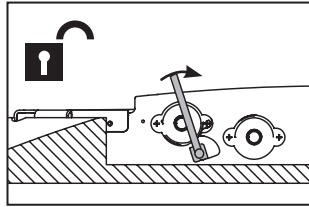

## 6. Move table

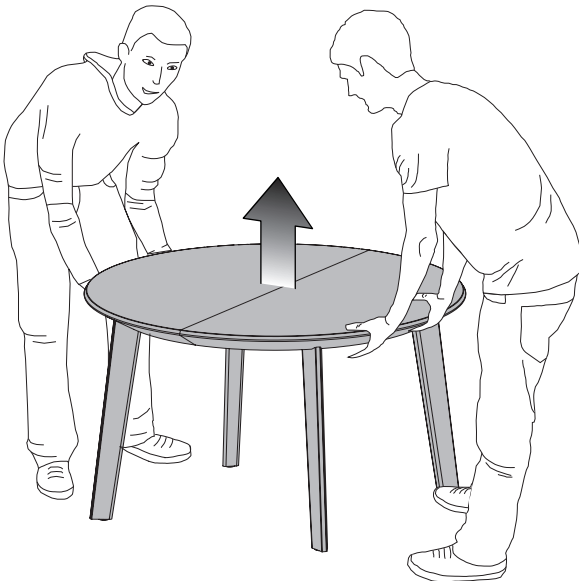

### **⚠ NOTICE**

- Be careful not to strain your back when lifting and carrying.
- Always lift the table when changing position.
- The assembled table must only be lifted and transported after it has been closed and locked.

## 7. Undo table lock

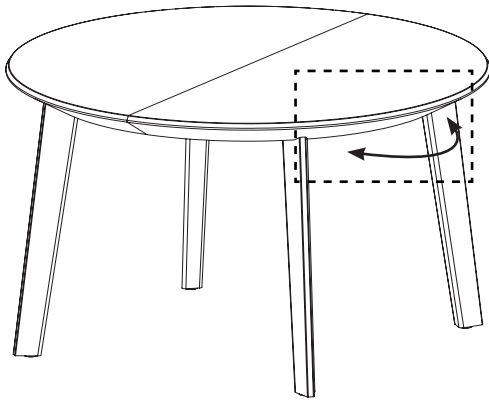

Turn lever as far as it will go

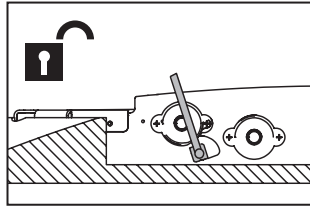
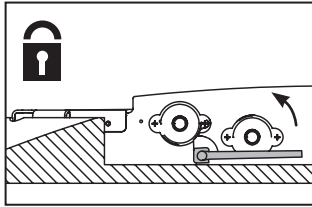

## 8. Extend table



### NOTICE

- Always pull pull-out out as far as possible.

**9. Fold open table extension leaf**

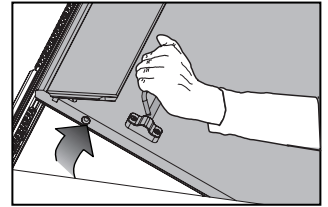
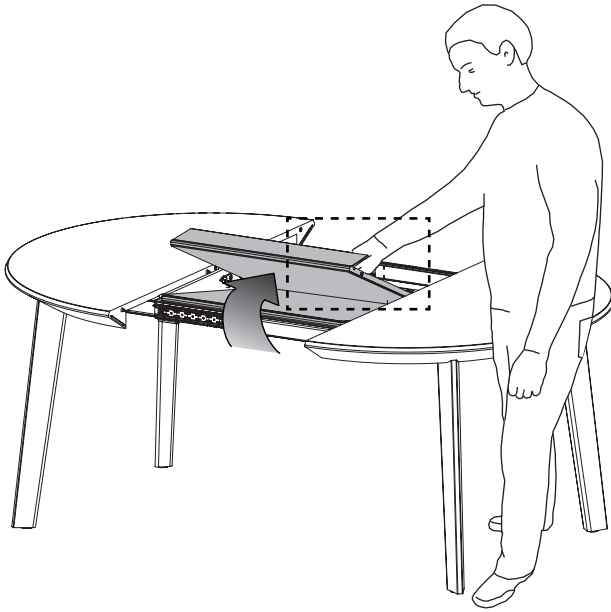

**10. Push the table tops together**

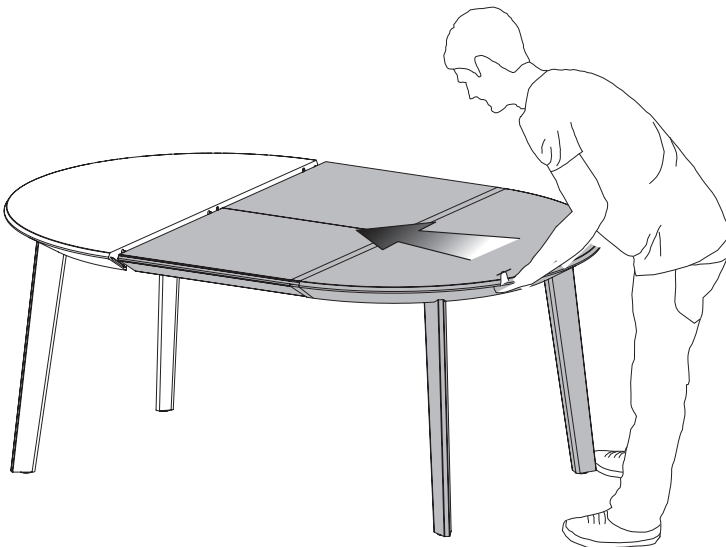

## 11. Lock table

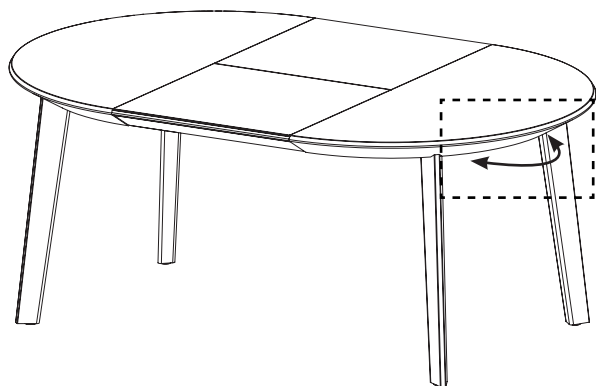

Turn lever as far as it will go

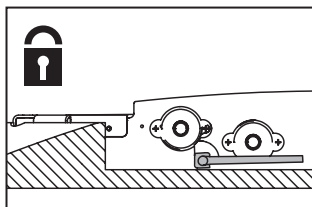
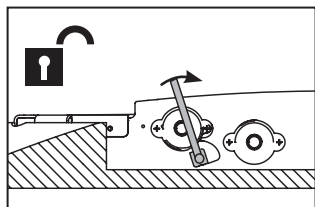

# TEAM 7

**TEAM 7 Natürlich Wohnen GmbH**

Braunauer Str. 26

4910 Ried im Innkreis, AUSTRIA

**Assembly Hotline: +43/7752-977321**

[www.team7-home.com](http://www.team7-home.com)

Errors and omissions excepted. All rights reserved for printing and typesetting errors.

Copyright

All parts of this document are protected by copyright. Any use above and beyond the narrow confines of copyright law is not permitted without the consent of TEAM 7 GmbH and is a punishable offence. This applies in particular to reproduction, microfilming as well as saving and processing in electronic systems.