

# NOTO

# TL-13

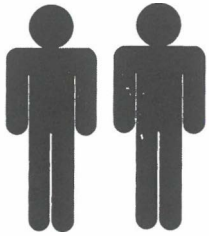

30 min

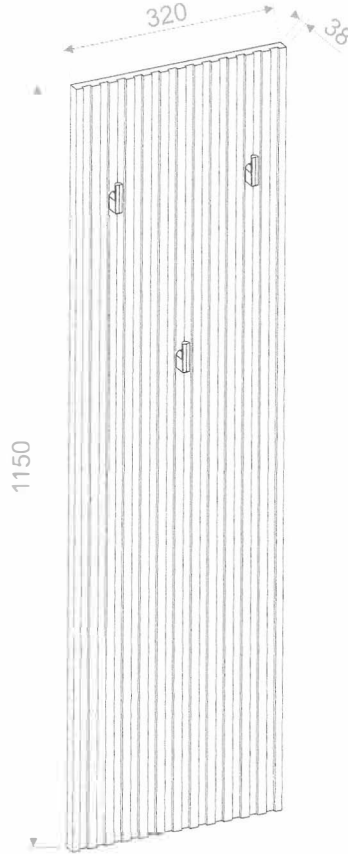
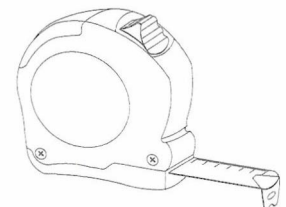
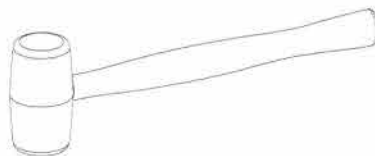
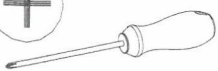
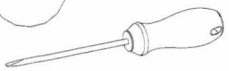

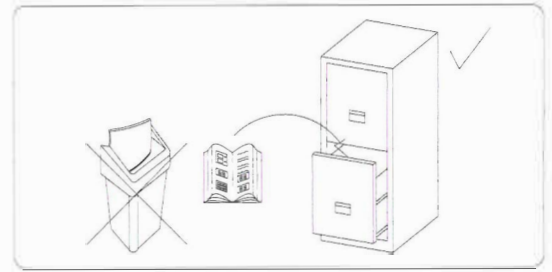
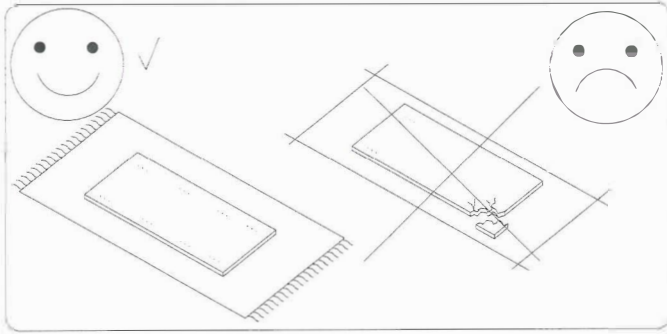

18_11	1150,0	320,0	18,0	1	1/1
-------	--------	-------	------	---	-----

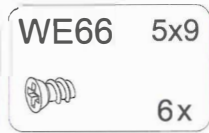
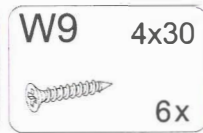
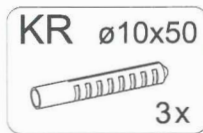
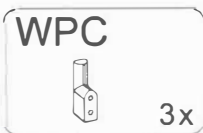
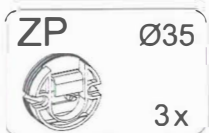
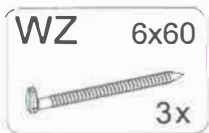
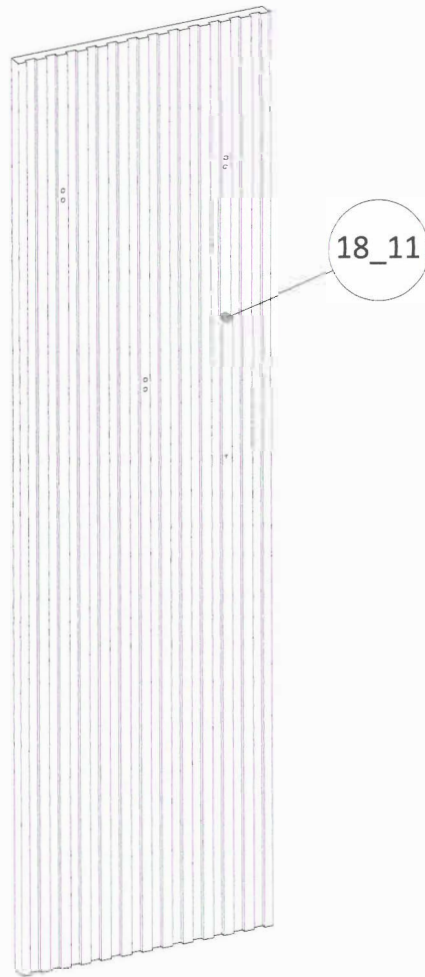

1

- ZP Ø35 3x
- WE66 5x9 6x
- OG 2x

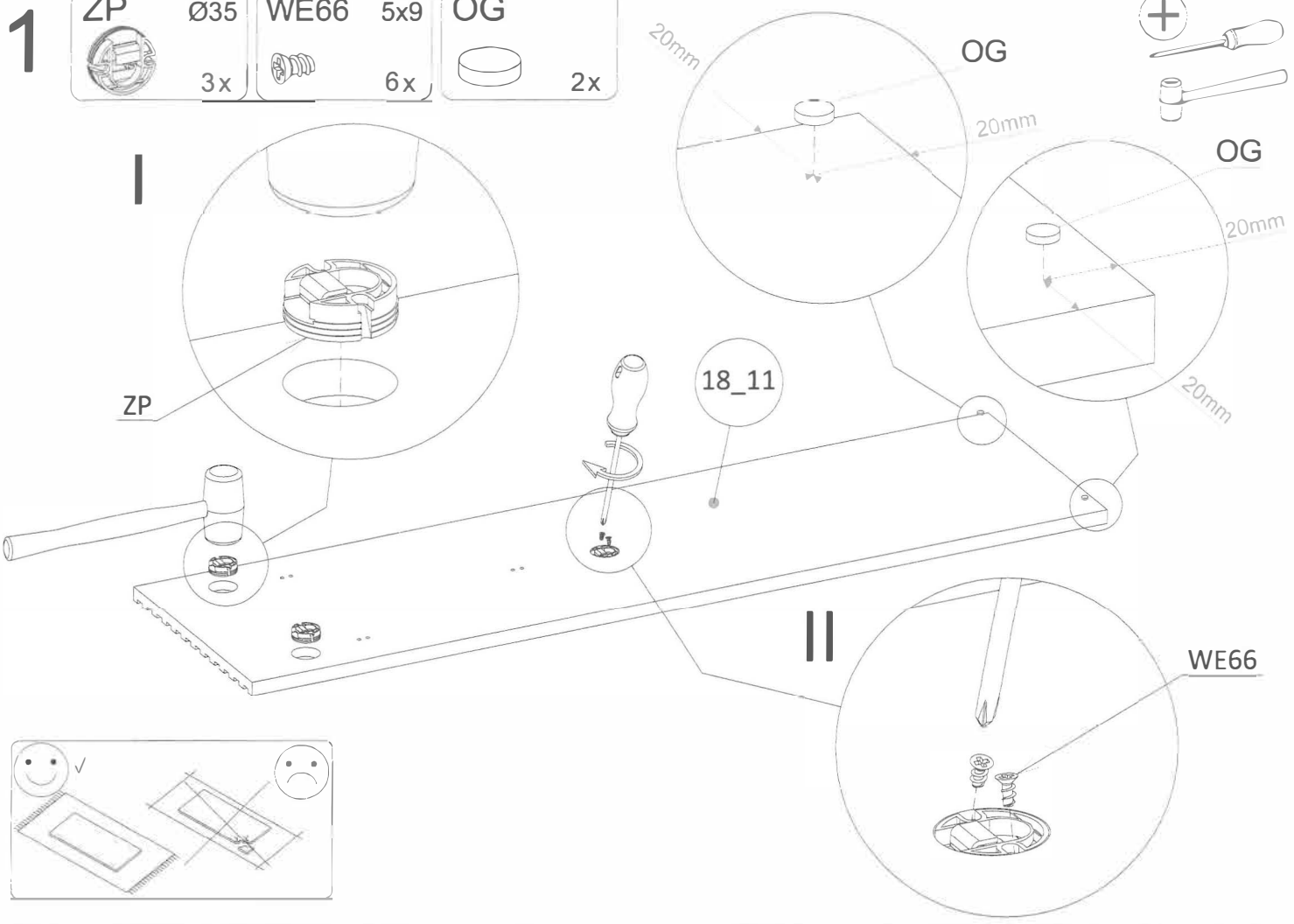

2

- WPC 3x
- W9 4x30 6x

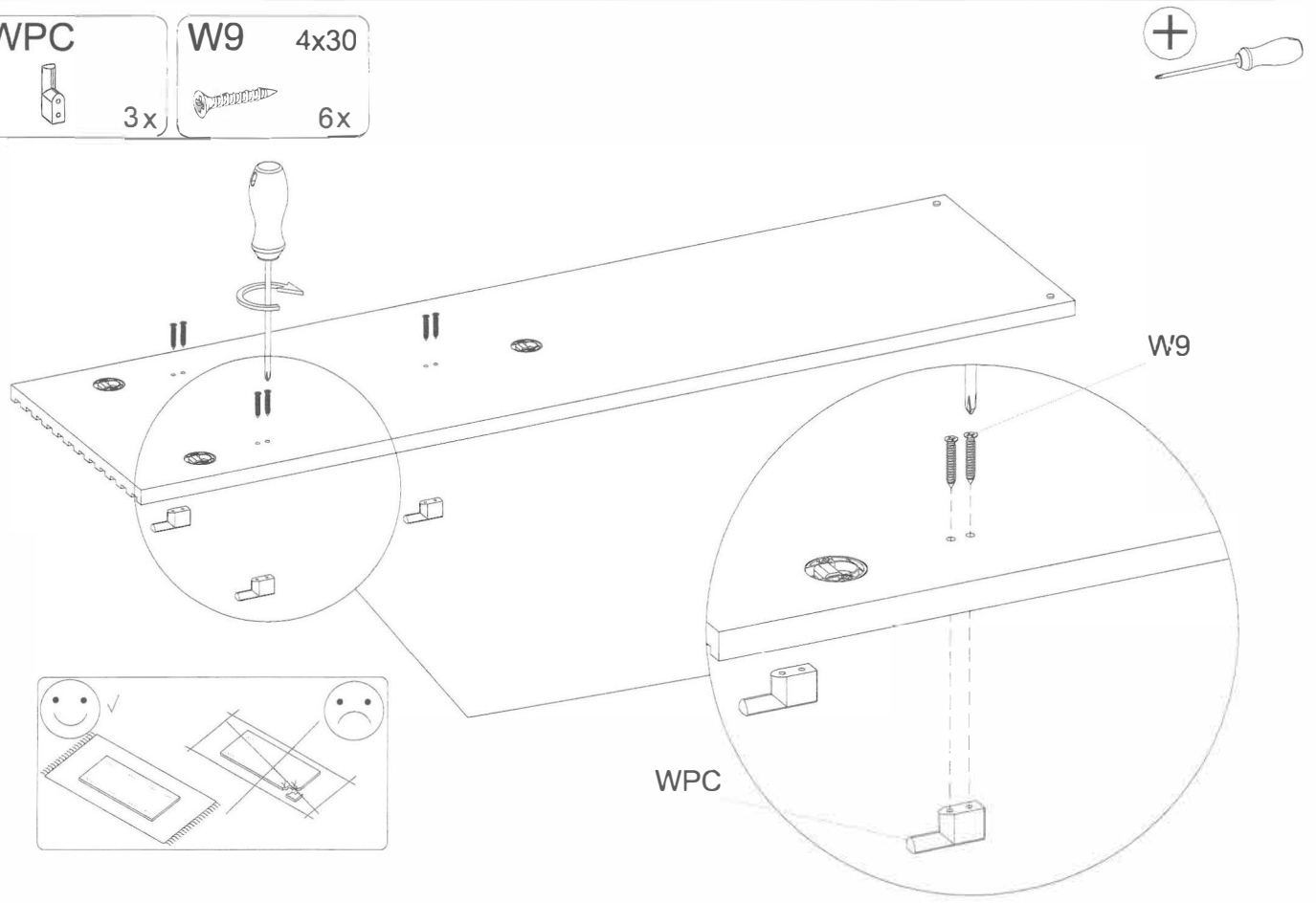

3

KR  $\varnothing 10 \times 50$   
3x

WZ 6x60  
3x

