

A	B1	B2	C1	C2	C3	C4	D
1	M277-3017	-	848	260	22	1	1/1
2	M277-4502	-	1146	850	16	1	1/1
3	M277-5006	-	851	20	22	2	1/1

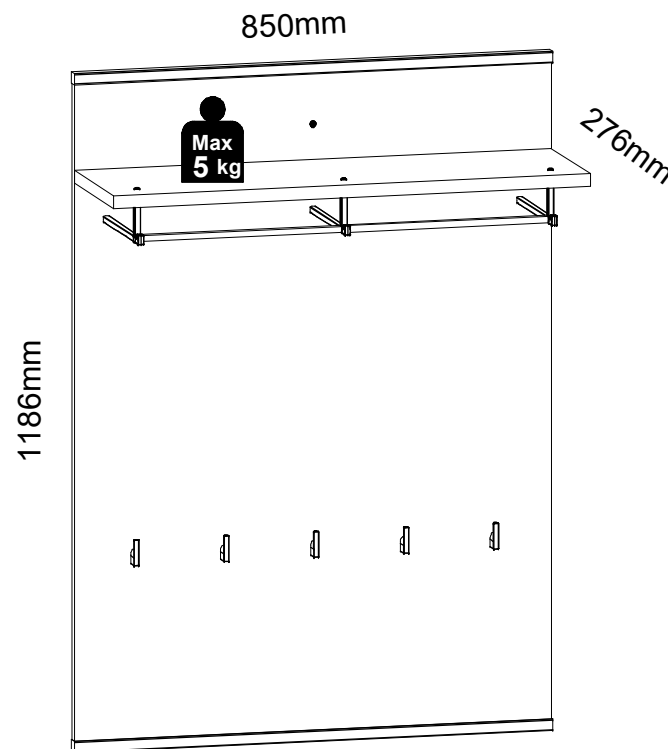

6x Ø5x11 mm e4	4x Ø7x60 mm e8	6x Ø8x30 mm f1	3x Ø10x50 mm f35	3x g2	
5x g39	1x g41\4L	1x g41\7	1x g41\4P	2x g41\9	1x z1
3x M4x28 mm j11	13x M4x25 mm j8	3x Ø6x60 mm p75	6x Ø15x12 mm #16 r1	6x 20\11 r42	1x Ø12x0,5 mm s59







A

M277-PAN_A

24270025/24

3 / 7

6x  20/11 r42	3x  g2	4x  Ø8x30 mm f1	6x  Ø5x11 mm e4	6x  Ø15x12 mm #16 r1
---	---	---	---	--

1 ▶

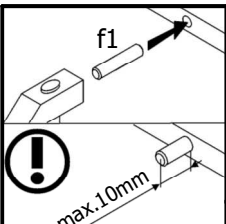
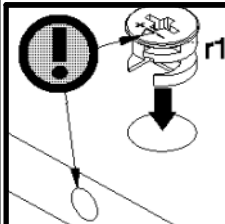
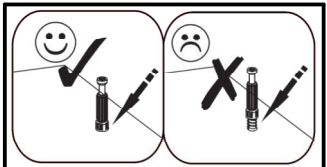
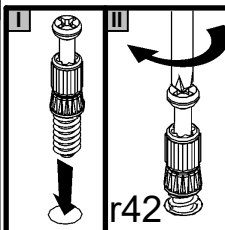
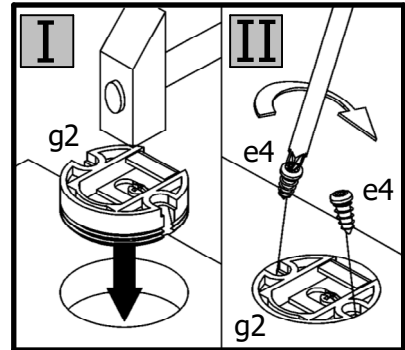
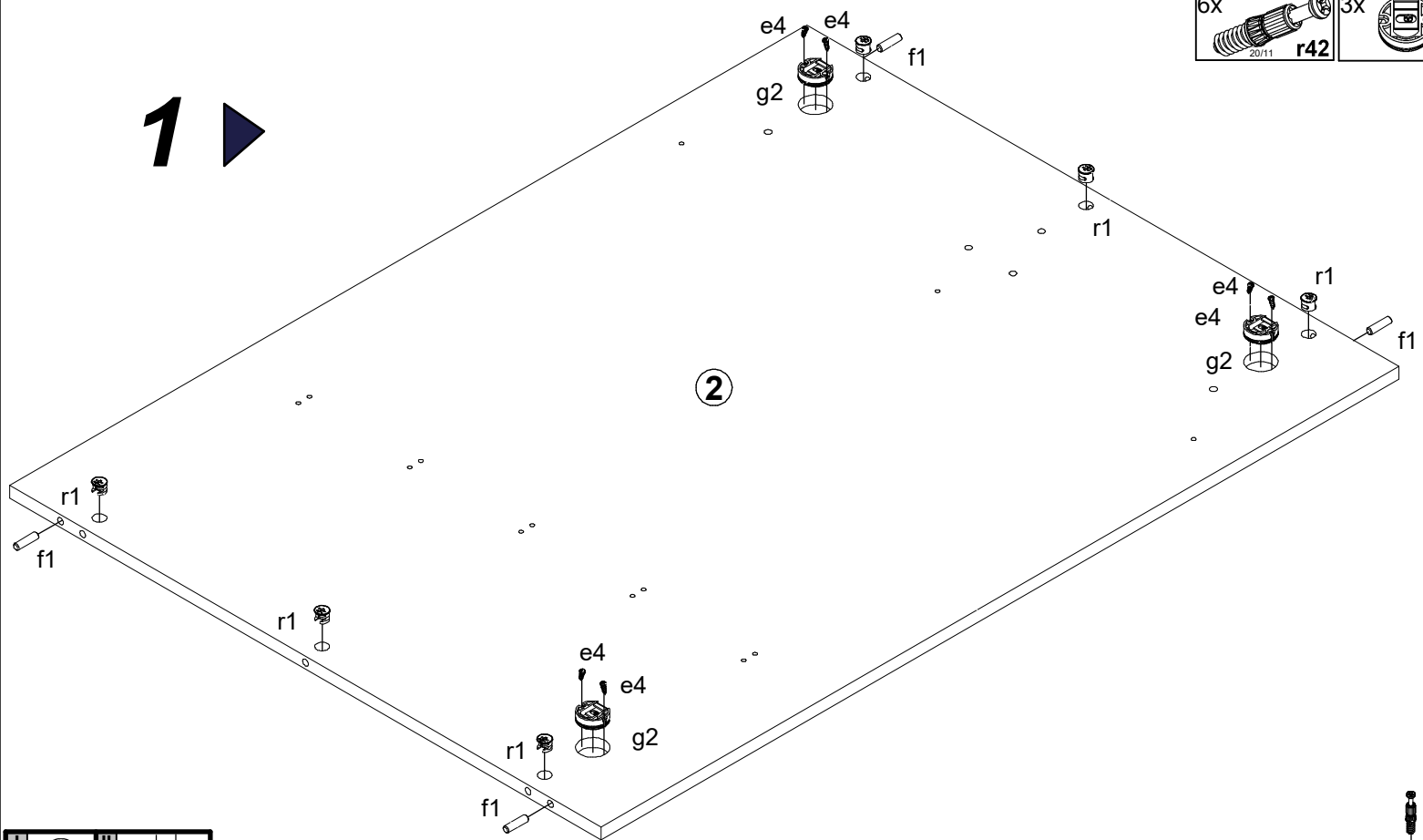

2x

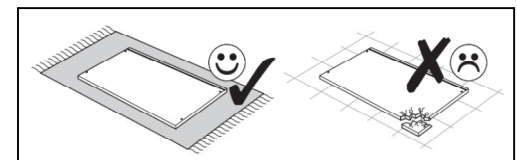
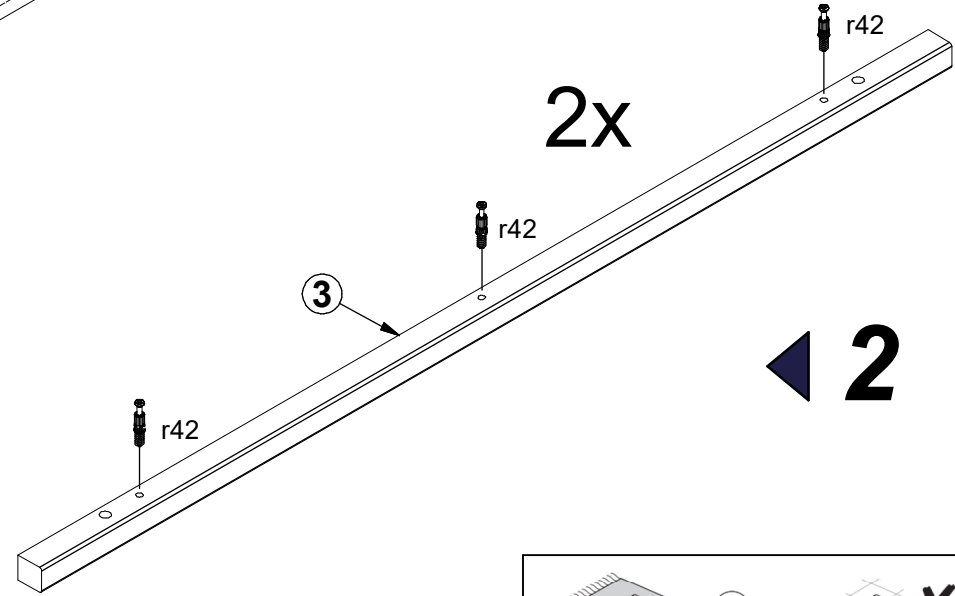

3 ▶

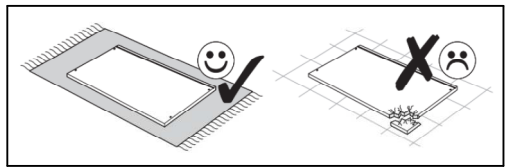
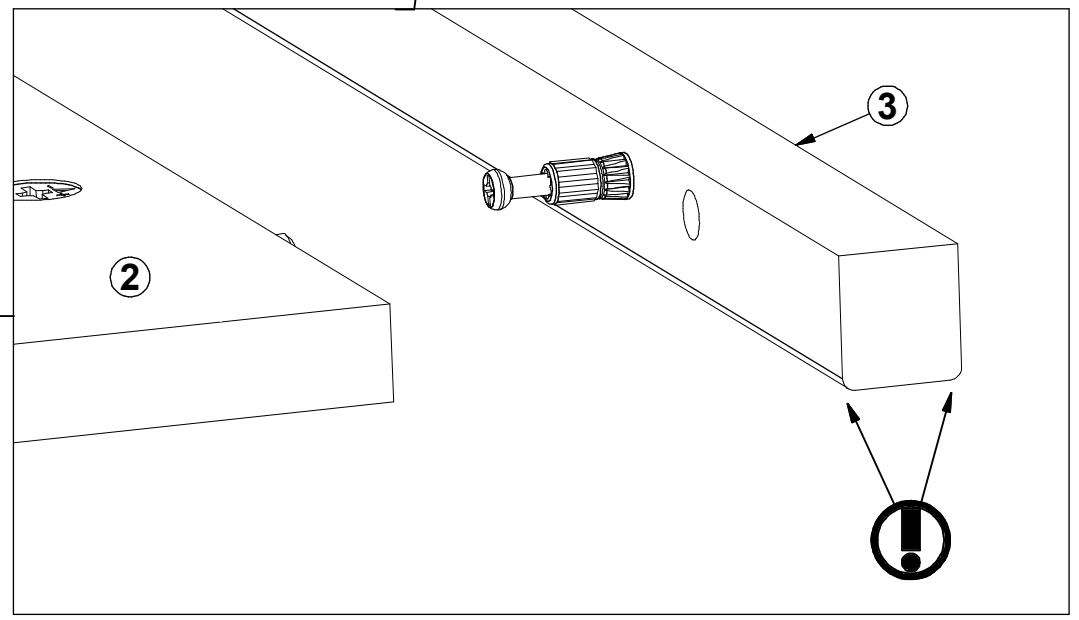
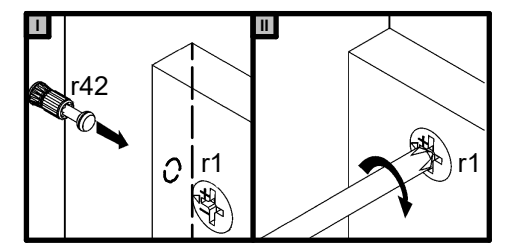
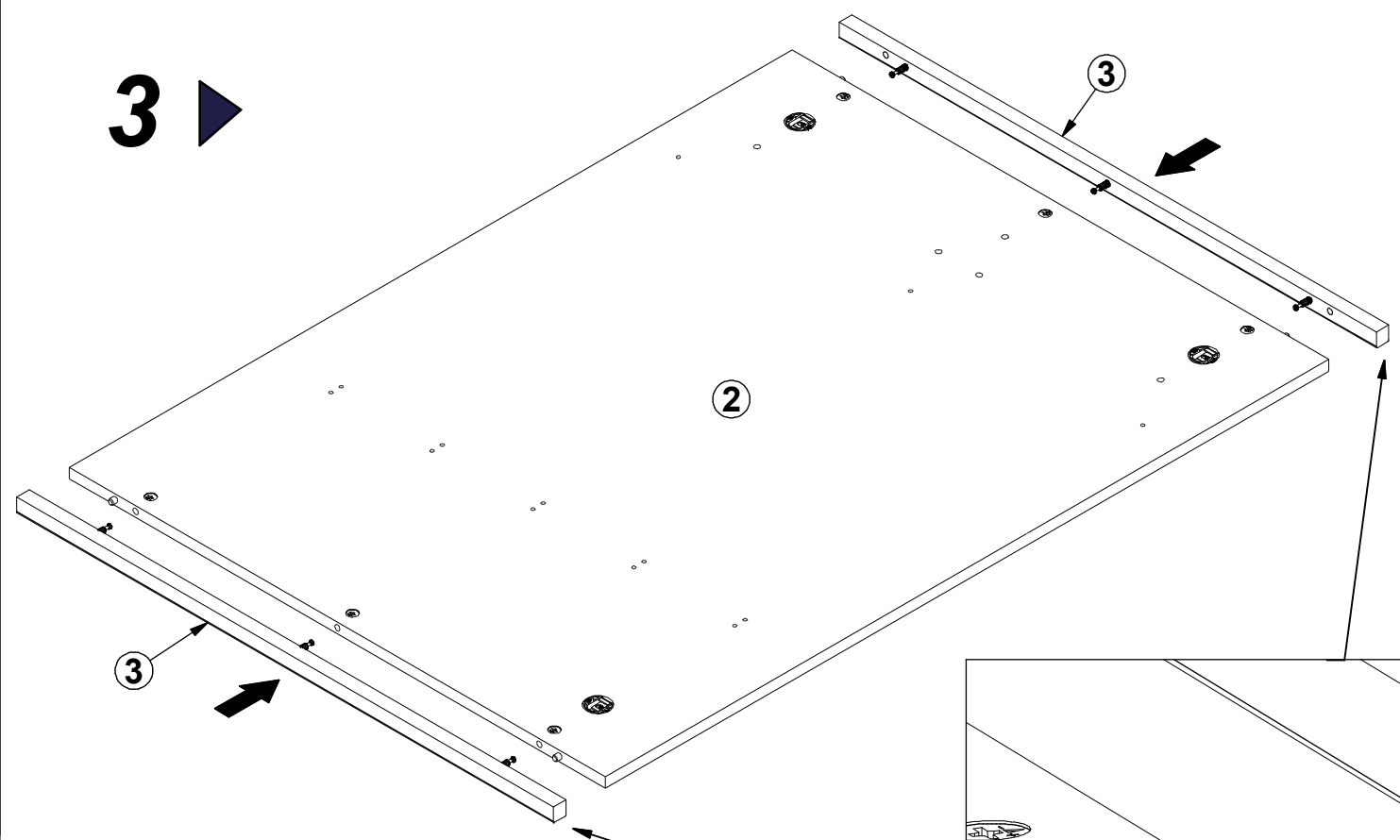

A

M277-PAN_A

24270025/24

5 / 7

4

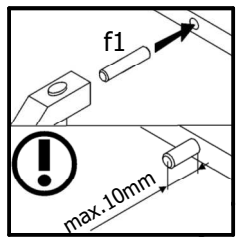
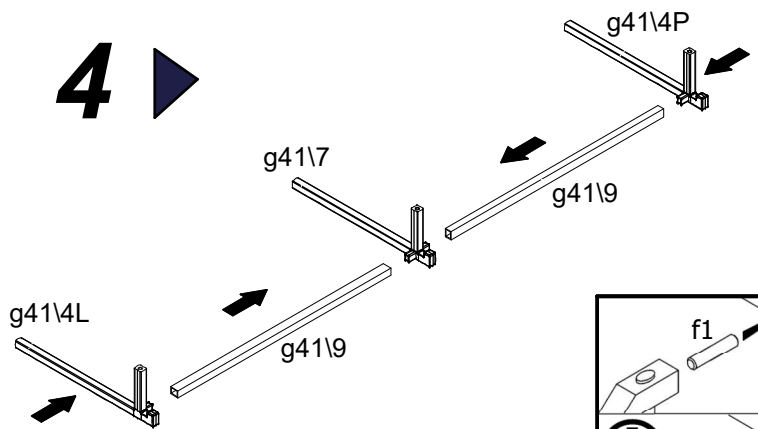

5

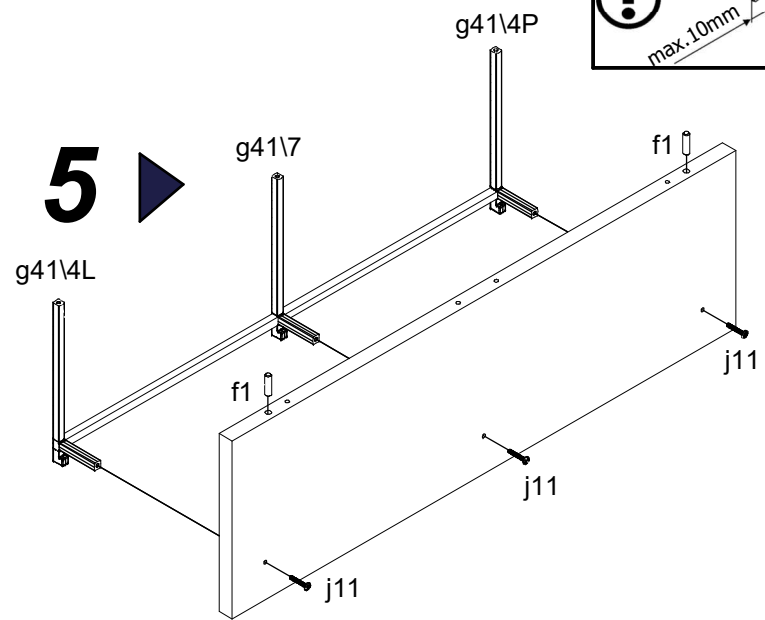

6

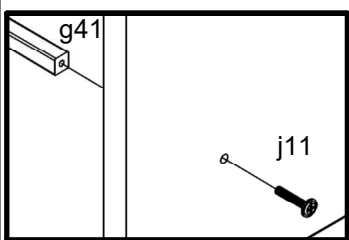
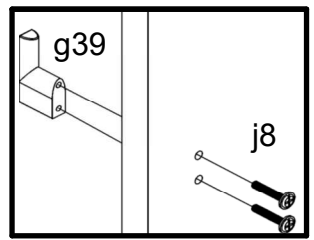
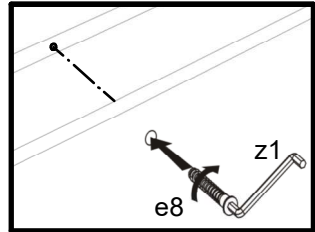
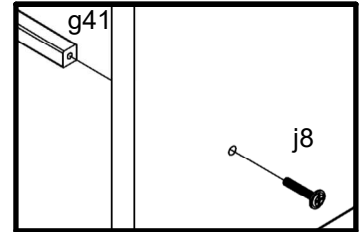
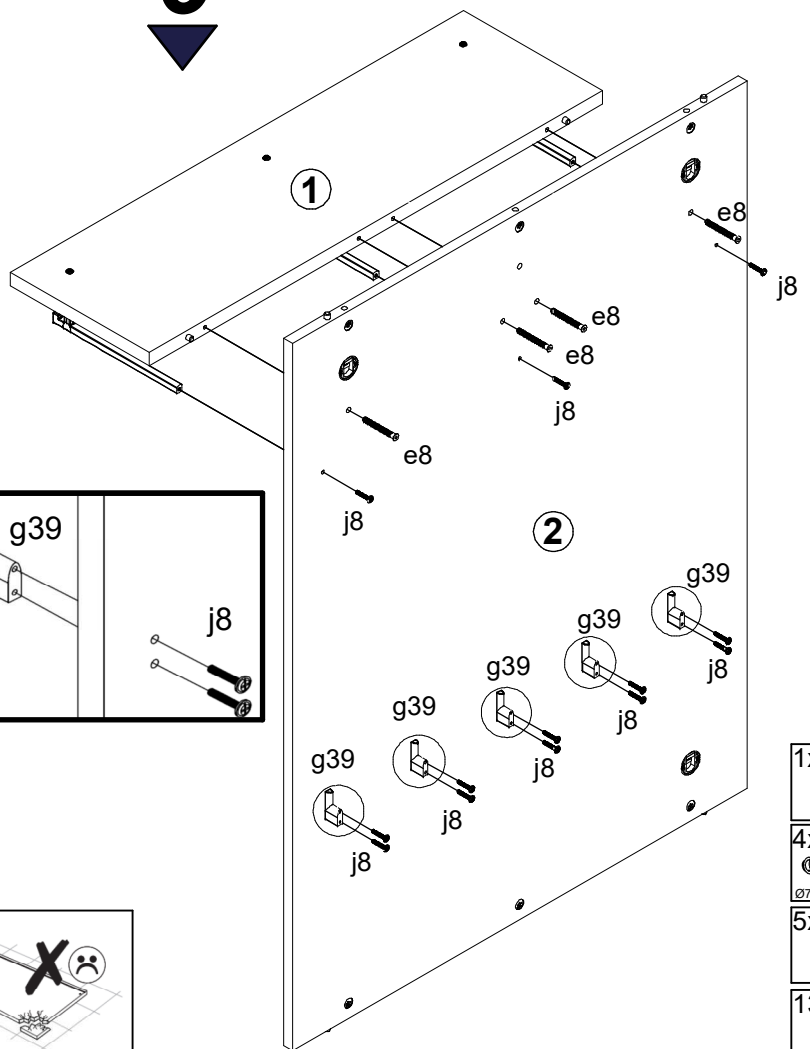

2x		1x	
3x		1x	
2x		1x	

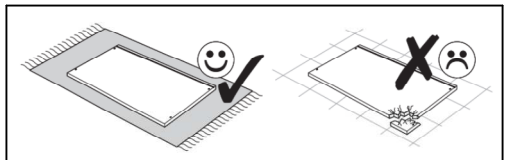

1x	
4x	
5x	
13x	

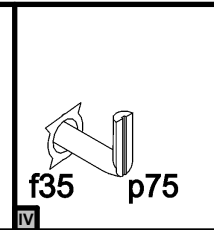
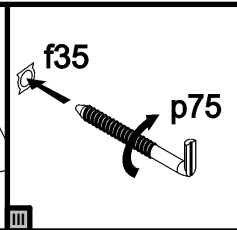
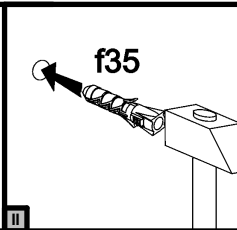
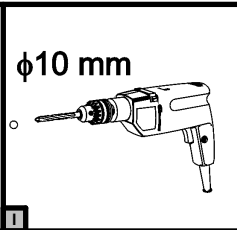
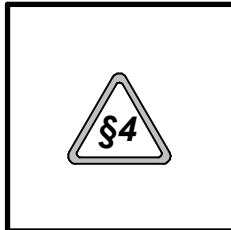
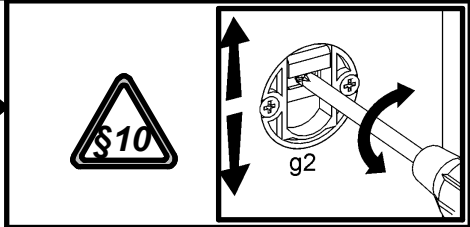
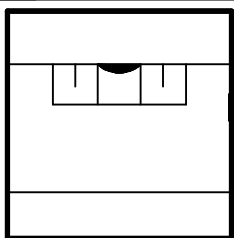

7

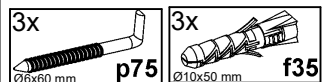
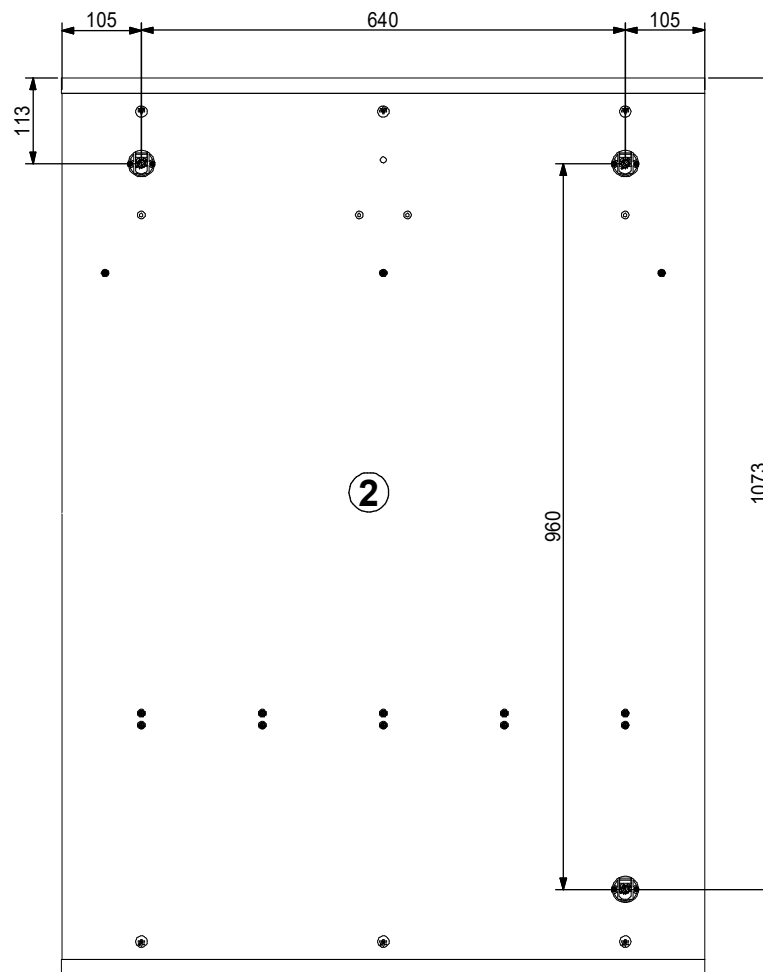
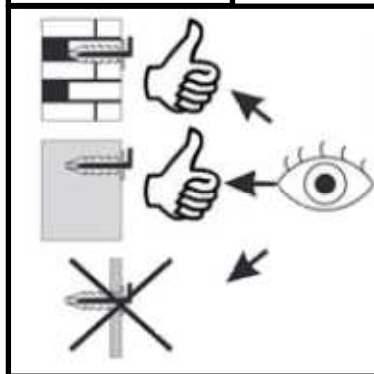
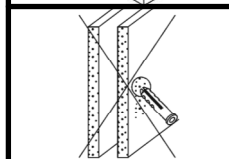
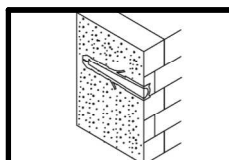
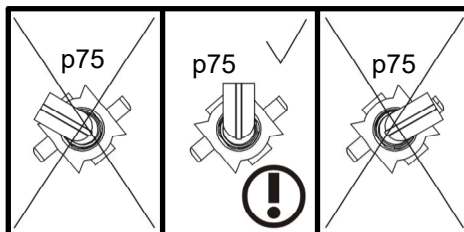
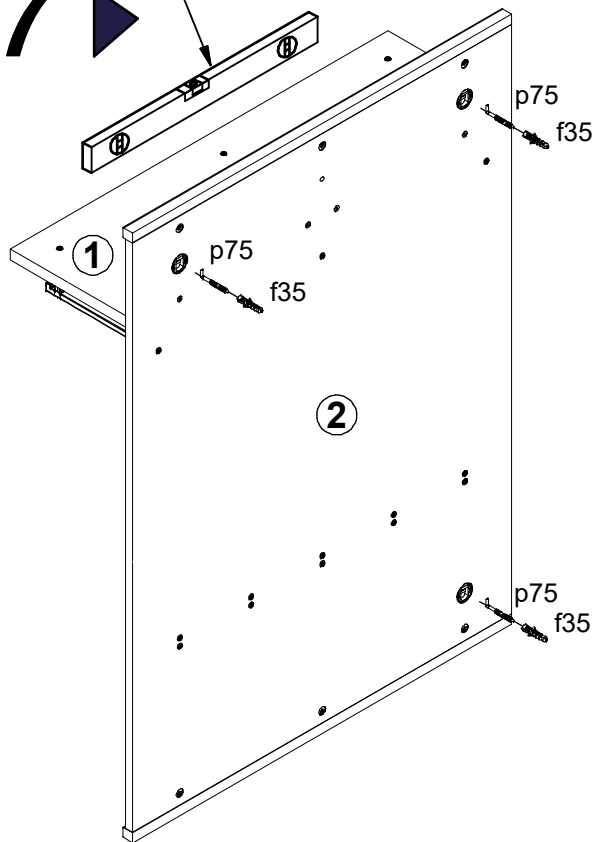

A

M277-PAN_A

24270025/24

7 / 7

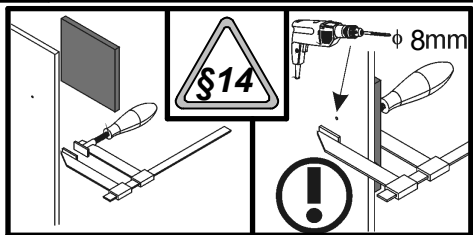

8

