

TEAM 7

Dokument für
die qualifizierte
Fachkraft!



Montageanleitung

Kids

Zubehör

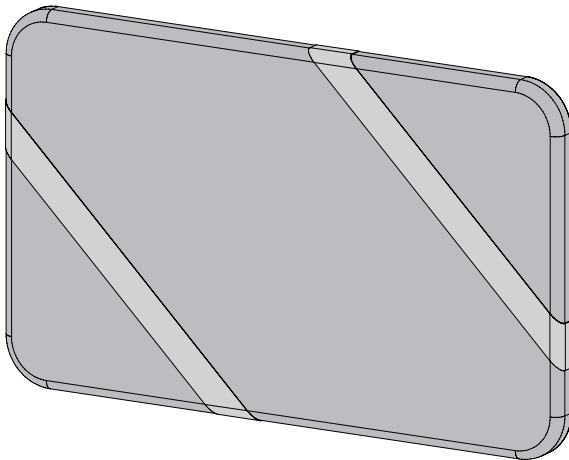
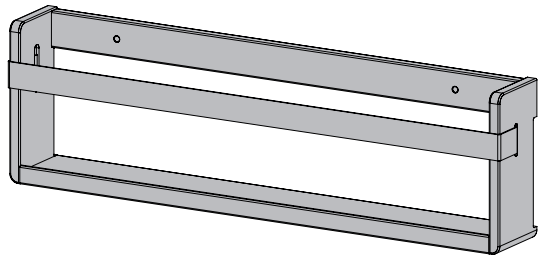

DE

012023
TD289010A

Nach der Montage
zur Aufbewahrung für
unsere Kunden!

! RAUMKLIMA

- Ideales Raumklima für Menschen, Pflanzen und Naturholzmöbel ist:

**rel. Luftfeuchtigkeit: 40 bis 60% und eine
Raumtemperatur: 18° bis 23° Celsius.**

- Bei längeren Über- bzw. Unterschreitungen dieser Werte kommt es zu Schwind- bzw. Quellvorgängen. In Folge können Verzug, Risse, offene Leimfugen und raue Oberflächen auftreten.

! PFLEGE

- Pflegeanleitungen (Naturholz-, Leder-, Stoff-, Stricktex-, Stein-, Glas-, Filz-, Keramik-, Metall-, und Arbeitsplattenpflege) entnehmen Sie bitte der TEAM 7 Homepage.

- Wichtige produkt- und warentypische Eigenschaften der TEAM 7 Naturholzmöbel finden Sie auch in unserem Service- und Gütepass unter:

<https://www.team7-home.com/at/de/service/service-und-guetepass/>



! DOKUMENTATION

- Bewahren Sie alle Unterlagen zum Kauf Ihres Möbelstücks, auch über die gesetzliche Gewährleistungspflicht von zwei Jahren, sorgsam auf.
- Wenn Sie Ersatz- oder Ergänzungsteile benötigen, erleichtern Ihnen die Kaufunterlagen die genaue Auskunft über das von Ihnen erworbene Produkt.
- Bei Transportschäden Ihres Möbelstücks, sind Fotos des beschädigten Teils in der Originalverpackung zwingend notwendig.

! ACHTUNG

- Beiliegendes Wandbefestigungs- Material eignet sich nur für Beton-, Vollziegel- und Hochlochziegel*-Wände. Für andere Wandtypen müssen Spezialübel verwendet werden.

* bei Hochlochziegel ohne Schlag bohren!

- Dabei ist vom Fachmann die Eignung des Untergrundes zu prüfen und zu kontrollieren, ob die Befestigungsmittel den auftretenden Kräften standhalten! Gegebenenfalls sind andere, der Wandbeschaffenheit entsprechende Befestigungsmittel zu wählen!
- Wird dieser Sicherheitshinweis nicht durchgeführt, übernimmt TEAM 7 keine Produkthaftung!

1. Werkzeuge

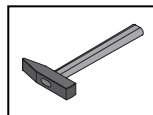
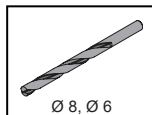
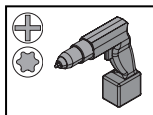
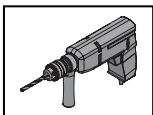
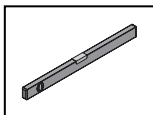
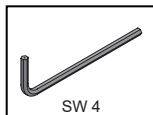

2. Beschläge

Dekobord

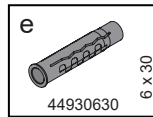
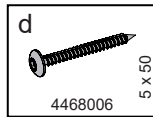
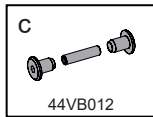
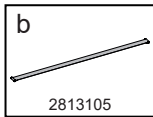
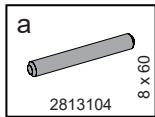

Wandpaneel

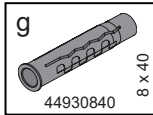
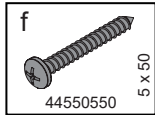

3. Dekobord

3.1 Band befestigen

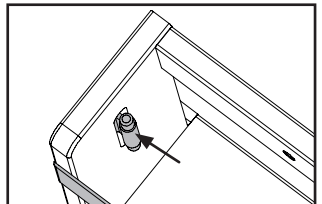
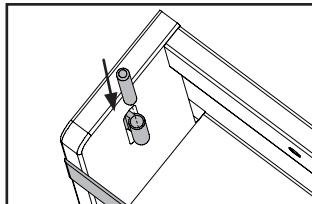
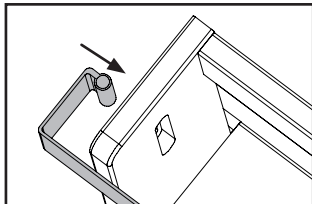
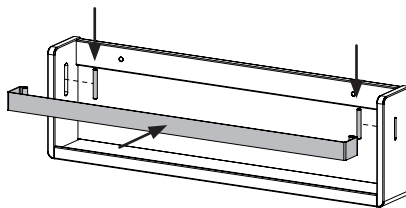
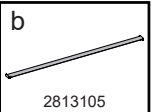
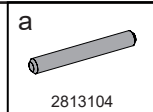

3.2 Montage an Wand

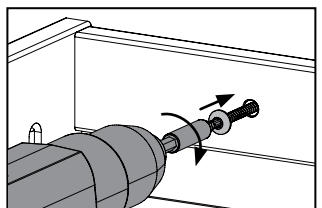
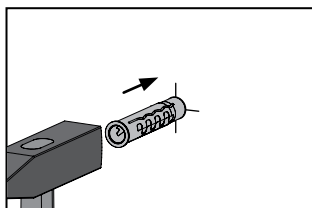
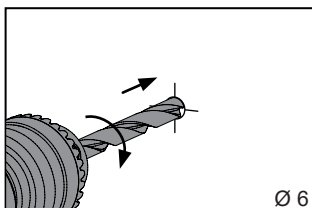
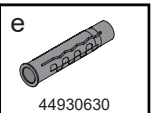
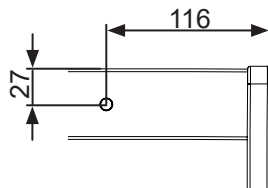
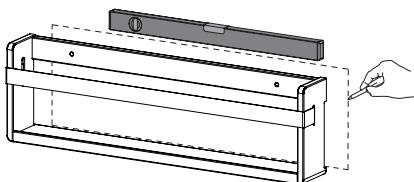

Alle Maße in Millimeter

3.3 Montage an Bettseite

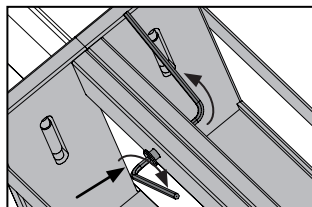
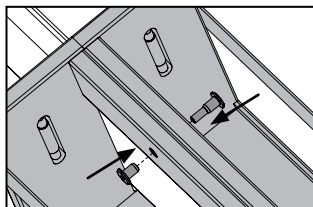
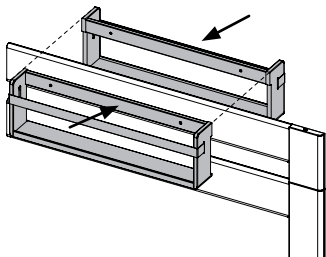
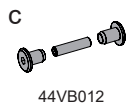

4. Wandpaneel

4.1 Montage an Wand

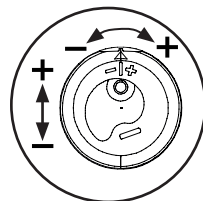
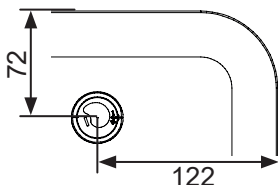
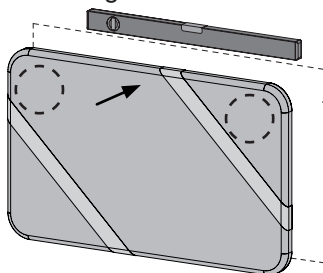
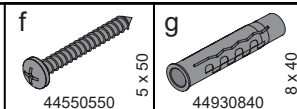

HINWEIS

- Das Paneel kann liegend oder stehend montiert werden.

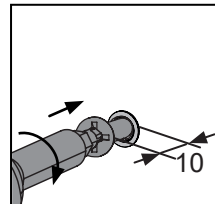
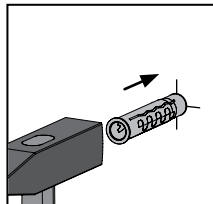
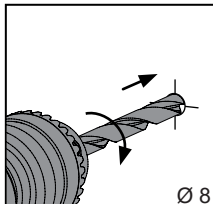

Alle Maße in Millimeter

TEAM 7

TEAM 7 Natürlich Wohnen GmbH

Braunauer Str. 26, 4910 Ried im Innkreis, AUSTRIA

Montagehotline: +43/7752-977321

www.team7-home.com

Änderungen, Irrtümer, Druck- und Satzfehler vorbehalten

Urheberrecht

Das Werk einschließlich aller Teile ist urheberrechtlich geschützt. Jede Verwertung außerhalb der engen Grenzen des Urheberrechtsgesetzes ist ohne Zustimmung der Firma TEAM 7 GmbH unzulässig und strafbar. Das gilt insbesondere für Vervielfältigung, Mikroverfilmung und die Einspeicherung und Verarbeitung in elektrische Systeme.

TEAM7



Instructions de montage

Kids

Accessoires

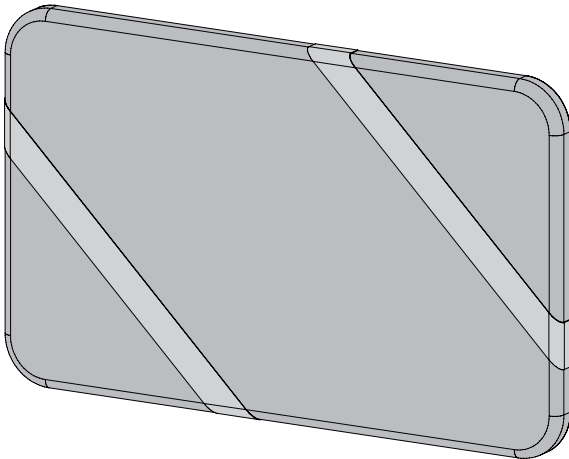
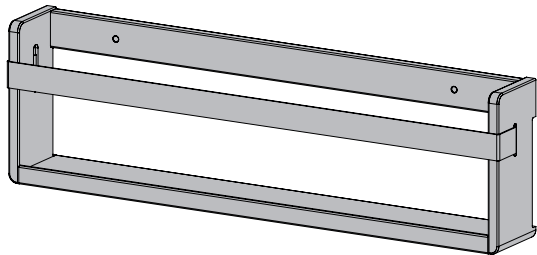

FR

CLIMAT INTERIEUR

- Climat intérieur idéal pour les personnes, les plantes et les meubles en bois naturel :

**une humidité relative comprise entre 40 et 60 % et
Température ambiante : de 18 à 23 °C.**

- Le dépassement supérieur et/ou inférieur prolongé de ces valeurs entraîne une rétraction ou un gonflement de ce matériau. Risque de déformation, fissure, joint décollé et surface rugueuse.

ENTRETIEN

- Les consignes d'entretien sont disponibles sur le site Internet TEAM 7 (entretien du bois naturel, du cuir, de l'étoffe, du Stricktex, de la pierre, du verre, métal, céramique du feutre et des plans de travail)
- Vous trouverez d'importantes caractéristiques des meubles en bois naturel TEAM 7 également dans le certificat de service et de qualité à l'adresse suivante :

<https://www.team7-home.com/at/de/service/service-und-guetepass/>



DOCUMENTATION

- Veuillez conserver soigneusement tous les documents d'achat de votre meuble, même au-delà de la garantie légale de deux ans.
- S'il vous faut des pièces de rechange ou des accessoires, tous les renseignements concernant le produit que vous aurez acheté figurent sur ces documents.
- Si votre meuble a été endommagé durant le transport, joindre impérativement des photos de la partie endommagée dans l'emballage d'origine.

ATTENTION

- Les accessoires de fixation murale, compris dans l'étendue de la livraison, sont conçus pour les murs en béton, en brique pleine et creuse*. Pour tous les autres types de mur, utiliser impérativement des chevilles spéciales.
* Ne pas utiliser de percussion pour les briques perforées !
- Un spécialiste est tenu de vérifier et de contrôler l'aptitude des accessoires de fixation à supporter les charges ! Le cas échéant, utiliser d'autres accessoires de fixation adaptés au mur !
- En cas de non-respect de cette consigne de sécurité, TEAM 7 se dégage de toute responsabilité !

1. Outils

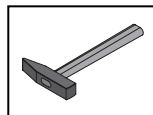
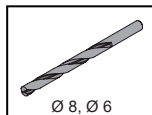
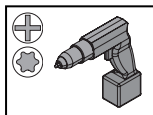
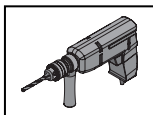
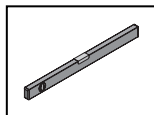
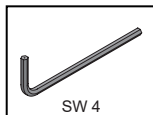

2. Ferrures

Étagère déco

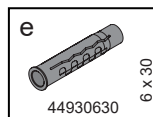
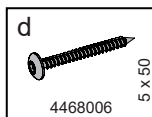
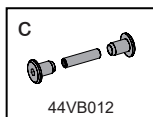
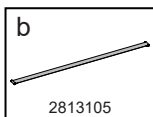
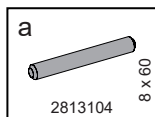

Panneau mural

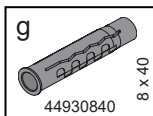
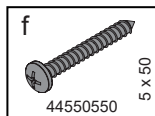

3. Étagère déco

3.1 Fixer la paumelle

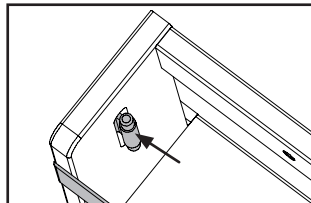
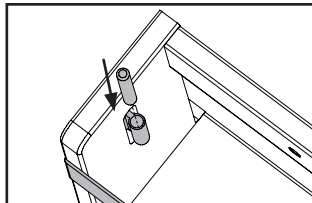
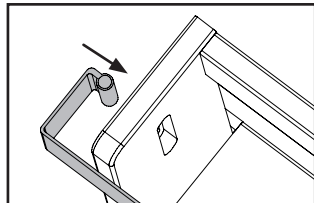
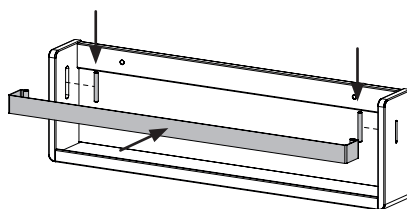

3.2 Montage au mur

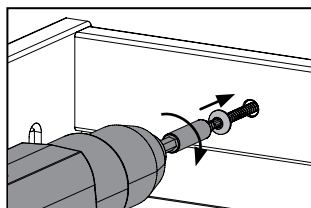
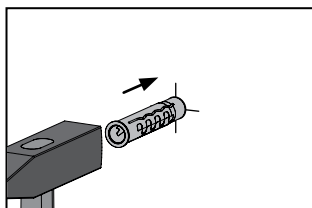
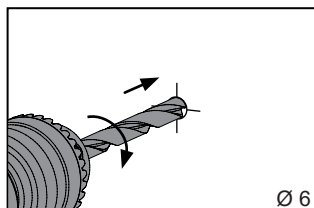
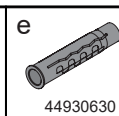
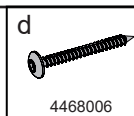
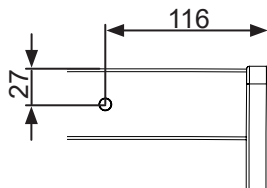
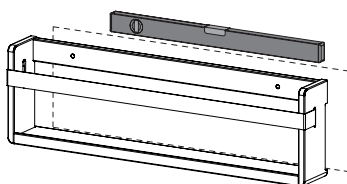

Toutes les mesures sont en millimètres!

3.3 Montage sur la paroi latérale de lit

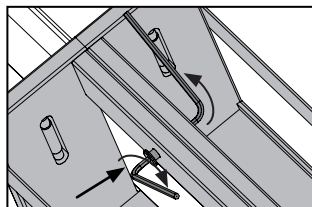
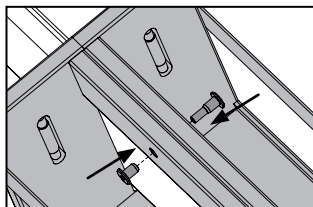
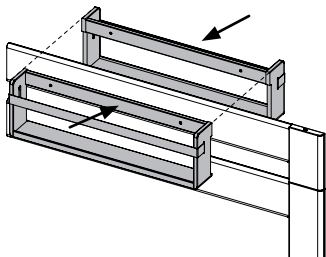
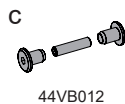

4. Panneau mural

4.1 Montage au mur

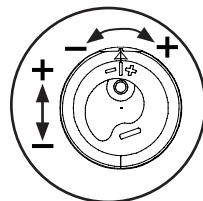
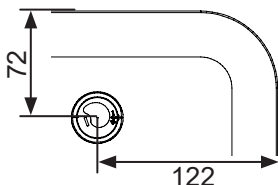
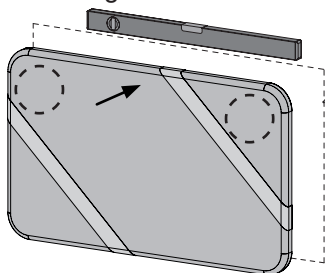
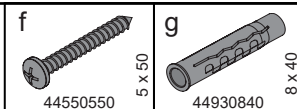

REMARQUE

- Le panneau peut être monté à l'horizontale ou à la verticale.

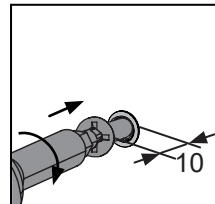
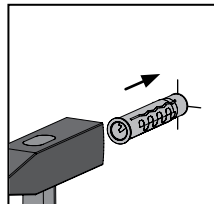
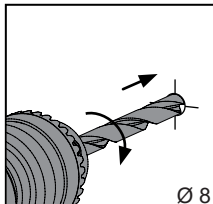

Toutes les mesures sont en millimètres!

TEAM 7

TEAM 7 Natürlich Wohnen GmbH

Braunauer Str. 26, 4910 Ried im Innkreis, AUSTRIA

Installation Hotline: +43/7752-977321

www.team7-home.com

Sous réserve de modification, d'erreur et de coquille

Droit d'auteur

L'œuvre et toutes ses parties sont protégées par le droit d'auteur. Toute utilisation, en dehors des limites strictes prévues par la loi sur le droit d'auteur, faite sans le consentement de l'entreprise TEAM 7 GmbH, est illicite et passible de poursuites judiciaires.

Ladite clause s'applique notamment à la reproduction, au microfilmage, ainsi qu'à la sauvegarde et au traitement par voie électronique.

TEAM7

Documento per il
personale qualifi-
cato!



Istruzioni per il montaggio

Kids

Accessori

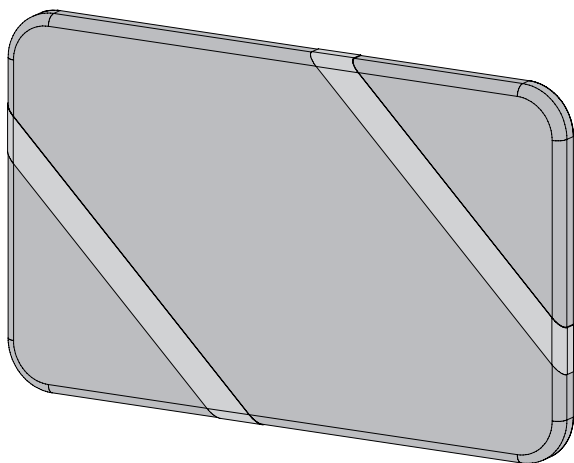
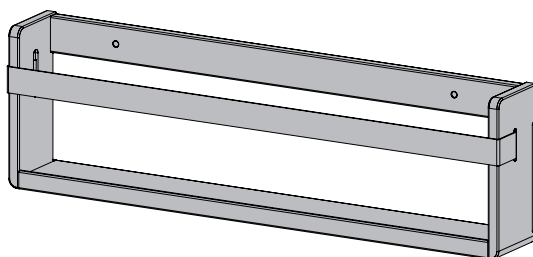

IT

012023
TD289010A

Dopo il montaggio da
conservare per i nostri
clienti!

CLIMA DELL'AMBIENTE

- Il clima ambiente ideale per persone, piante e mobili in legno naturale è:

**Umidità atmosferica rel. 40 - 60% e una
Temperatura ambiente: fra 18 e 23° Celsius.**

- In caso di superamento in eccesso o in difetto di questi valori per lungo tempo, si verificano ritiri o rigonfiamenti. In seguito possono verificarsi svirgolamento, crepe, scollamento di fughe e irruvidimento delle superfici.

MANUTENZIONE

- Per le istruzioni di manutenzione (cura di pannelli in legno naturale, pelle, stoffa, Stricktex, pietra, vetro, Metallo, ceramica feltro e piani di lavoro) consultare il sito web di TEAM 7.
- Troverete importanti caratteristiche dei mobili in legno naturale TEAM 7 anche nel nostro pass assistenza e qualità qui:

<https://www.team7-home.com/at/de/service/service-und-guetepass/>



DOCUMENTAZIONE

- Conservare accuratamente tutta la documentazione relativa all'acquisto di questo mobile, anche oltre la garanzia di due anni obbligatoria per legge.
- Quando si richiedono parti di ricambio o di integrazione, la documentazione d'acquisto facilita la ricerca di informazioni precise sul prodotto acquistato.
- In caso di danni ai mobili causati dal trasporto, è assolutamente necessario produrre foto della parte danneggiata nell'imballaggio originale.

ATTENZIONE

- Il materiale accluso per il fissaggio alla parete è idoneo per pareti in calcestruzzo, mattoni pieni e mattoni forati alti*. Per altri tipi di parete, utilizzare tasselli speciali.
* per i mattoni forati, non usare la percussione!
- Il tecnico deve controllare l'idoneità del sottofondo e verificare se i mezzi usati per il fissaggio sono in grado di sopportare le forze generate! Scegliere eventualmente mezzi di fissaggio diversi che siano idonei per le caratteristiche della parete!
- TEAM 7 non si assume alcuna responsabilità del prodotto in caso di mancato rispetto di questa avvertenza!

1. Attrezzi

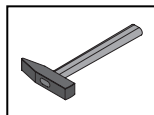
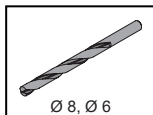
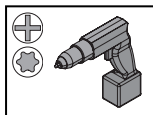
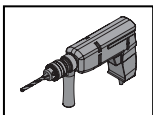
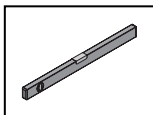
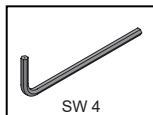

2. Ferramenta

Pannello decorativo

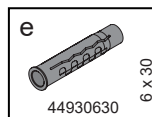
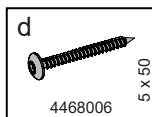
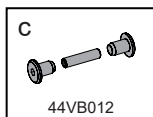
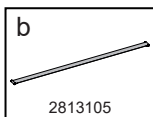
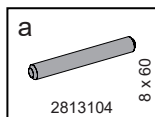

Pannello a parete

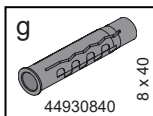
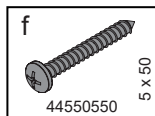

3. Pannello decorativo

3.1 Fissare la bandella

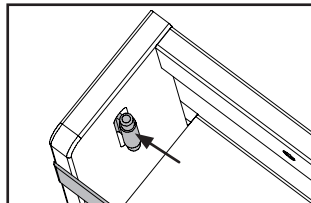
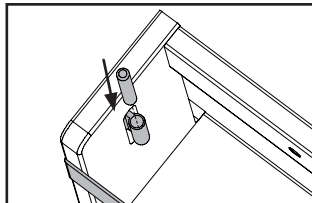
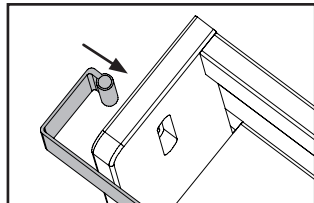
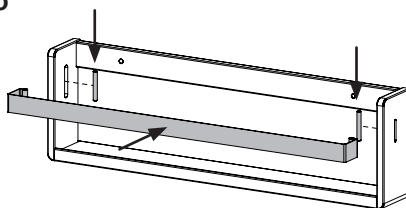
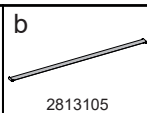
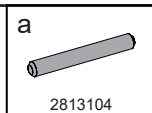

3.2 Montaggio a parete

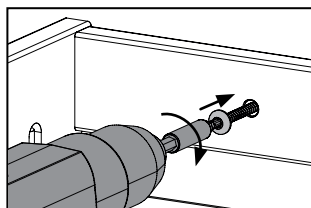
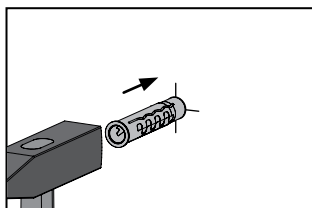
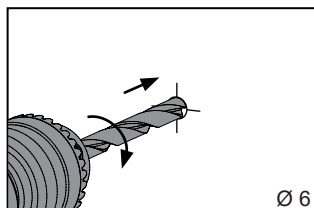
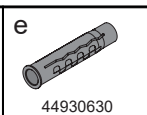
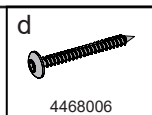
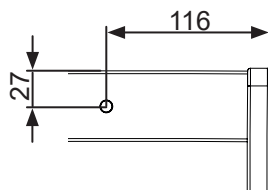
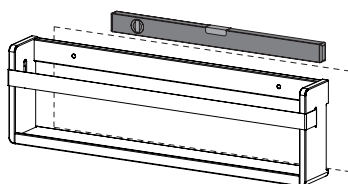

Tutte le misure sono in millimetri!

3.3 Montaggio su longherone

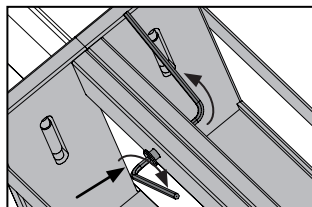
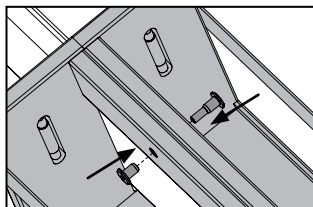
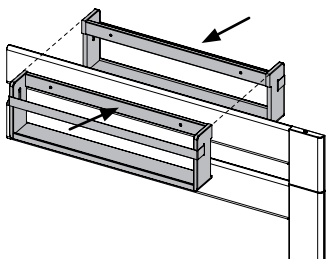
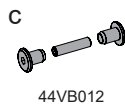

4. Pannello a parete

4.1 Montaggio a parete

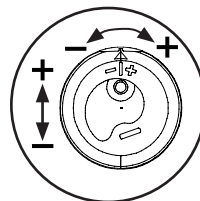
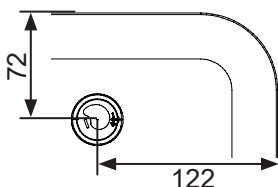
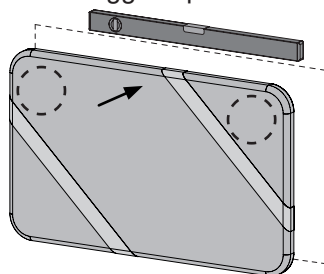
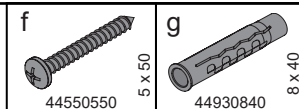

AVVERTENZA

- Il pannello può essere montato orizzontalmente o verticalmente.

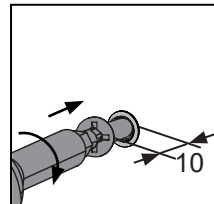
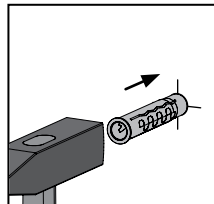
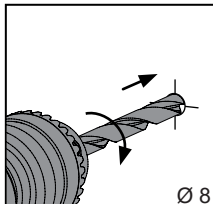

Tutte le misure sono in millimetri!

TEAM 7

TEAM 7 Natürlich Wohnen GmbH

Braunauer Str. 26, 4910 Ried im Innkreis, AUSTRIA

Hotline installazione: +43/7752-977321

www.team7-home.com

Con riserva di modifiche, errori, errori di stampa e impaginazione

Dritto d'autore

La pubblicazione è tutelata da diritto d'autore in tutte le sue componenti. Qualsiasi utilizzo che esuli dagli stretti limiti imposti dalla legge sul diritto d'autore è vietato e perseguibile ai fini di legge senza l'approvazione della ditta TEAM 7 GmbH. Questo vale in particolare per la copia, la riproduzione con microfilm e la memorizzazione ed elaborazione in sistemi elettrici.

TEAM 7



Assembly Instruction

Kids

Accessories

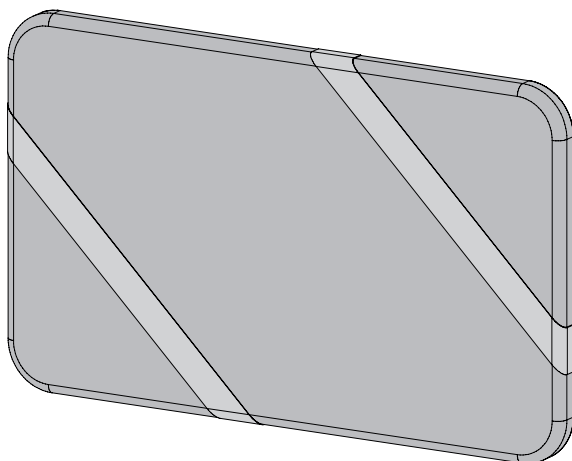
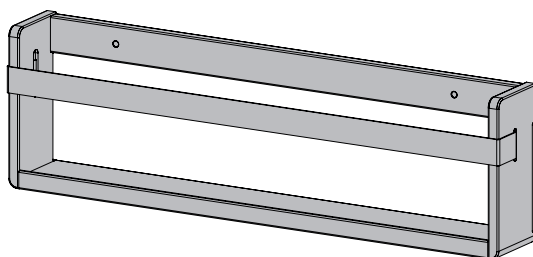

GB

! INDOOR CLIMATE

- Ideal indoor climate for human beings, plants and furniture made of natural wood is:

**rel. humidity: 40 to 60% and a
Room temperature: 18° to 23° Celsius.**

- If these levels are exceeded or not reached for any prolonged period, swelling or shrinkage will occur. This may result in warping, cracking and rough surfaces.

! CARE

- Care instructions (care of natural wood, leather, fabric, Stricktex, stone, glass, felt, metal, ceramics and worktops) can be found on the TEAM 7 website.

- Major typical product properties of natural wood furniture from TEAM 7 can also be found in our service and quality certificate on:

<https://www.team7-home.com/at/de/service/service-und-guetepass/>



! DOCUMENTATION

- Keep all documents relating to the purchase of your item of furniture in a safe place, also beyond the statutory warranty period of two years.
- If you need replacement or additional parts, please refer to the purchase documentation as this will give you exact information on the product you have purchased and make the process easier.
- If your item of furniture is damaged in transit, it is imperative that you provide photographs of the damaged part while it is still in the original packaging.

! IMPORTANT

- The enclosed wall fixing material can only be used for concrete walls, solid brick walls and walls made from vertically perforated bricks*. Special wall plugs must be used for all other wall types.
* Work without impact when drilling into vertically perforated bricks!
- The suitability of the substrate must be examined by a qualified person to establish whether the mounting hardware can withstand the applied forces! If necessary, select other mounting hardware that is suitable for the particular nature of the wall.
- TEAM 7 cannot accept any liability for the product if this safety instruction is disregarded!

1. Tools

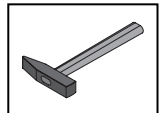
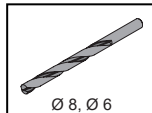
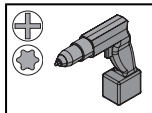
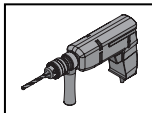
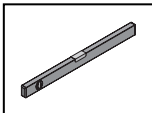
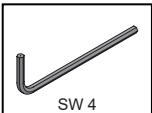

2. Fittings

Decorative shelf

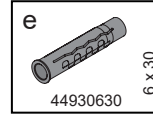
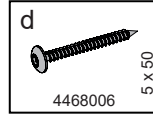
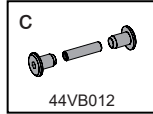
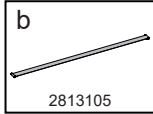
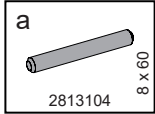

Wall panel

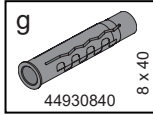
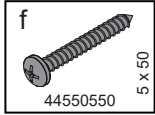

3. Decorative shelf

3.1 Securing tape

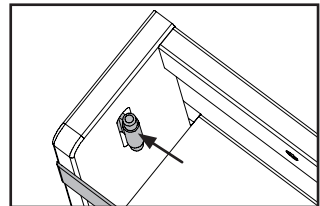
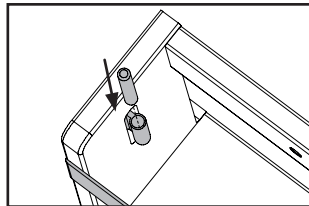
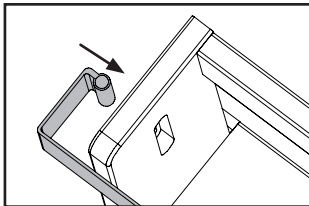
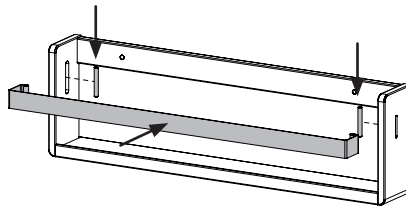
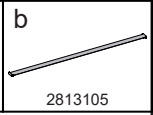
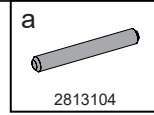

3.2 Wall mounting

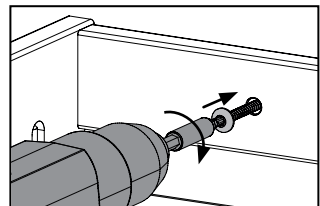
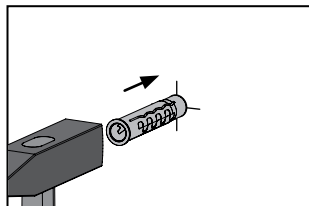
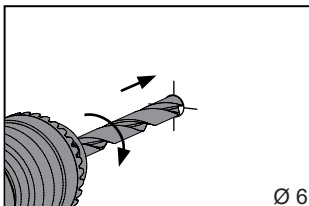
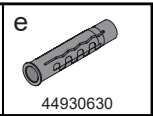
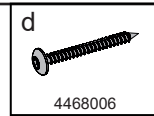
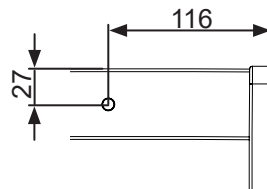
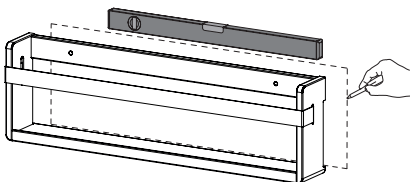

All measurements in millimetres!

3.3 Fitting to bed side

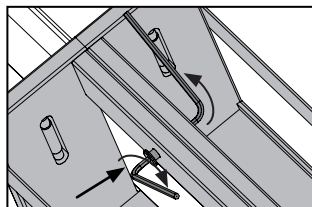
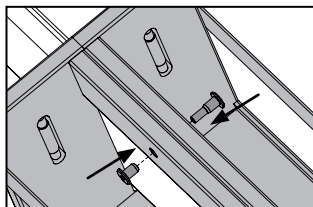
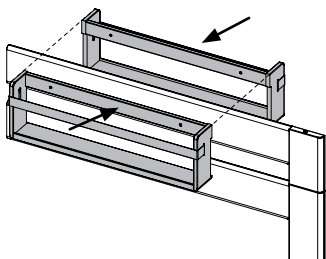
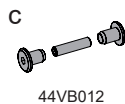

4. Wall panel

4.1 Wall mounting

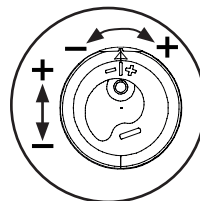
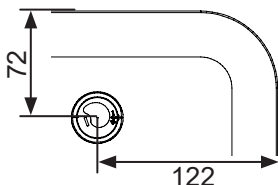
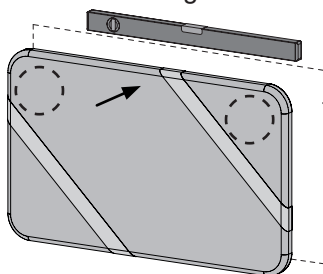
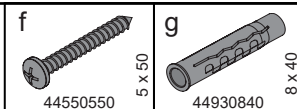

NOTICE

- The panel can be fitted horizontally or vertically.

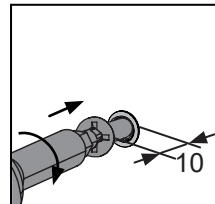
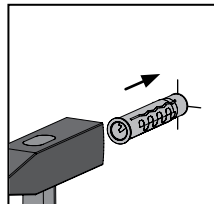
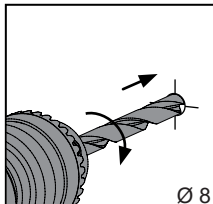

All measurements in millimetres!

TEAM 7

TEAM 7 Natürlich Wohnen GmbH

Braunauer Str. 26, 4910 Ried im Innkreis, AUSTRIA

Assembly Hotline: +43/7752-977321

www.team7-home.com

Errors and omissions excepted. All rights reserved for printing and typesetting errors.

Copyright

All parts of this document are protected by copyright. Any use above and beyond the narrow confines of copyright law is not permitted without the consent of TEAM 7 GmbH and is a punishable offence. This applies in particular to reproduction, microfilming as well as saving and processing in electronic systems.