

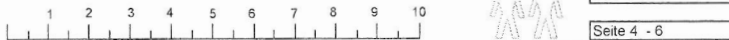



<b>A</b> Höhe 120/150	<b>B</b> Höhe 120/150	<b>C</b> Höhe 120/150	<b>D</b> Höhe 120/150	<b>E</b> Höhe 120/150	<b>F</b> Höhe 120/150	<b>Modellnummer</b> 2285-86/2292-95/2302-05
						<b>Stand</b> 26.01.2023
701/722/214/275	728/729/191/365	627/638	506/698	621/622	635/618/893/192	<b>Revision</b> 16
Werkseitig	Werkseitig	Kundenseitig	Werkseitig	Kundenseitig	Kundenseitig	<b>Verfasser</b> IKR









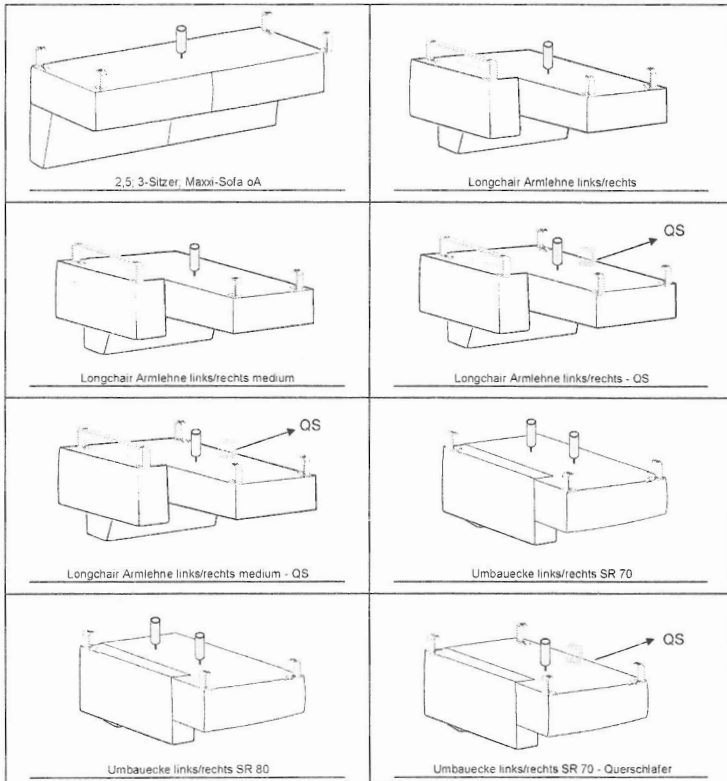

<b>G</b> Höhe 120/150	<b>H</b> Höhe 120/150	<b>I</b> Höhe 120/150	<b>J</b> Höhe 120/150	<b>K</b> Höhe 120/150	<b>L</b> Höhe 120/150	Seite 4 - 6
636/637/869/870	877/878	875/876	841/873, 862/863	251/253, 252/254	846/872, 871/864	
Kundenseitig	Kundenseitig	Kundenseitig	Kundenseitig	Kundenseitig	Kundenseitig	
<b>M</b> Höhe 120/150	<b>N</b> Höhe 120/150	<b>O</b> Höhe	<b>P</b> Höhe	<b>Q</b> Höhe	<b>R</b> Höhe	
867/868	Stutzfuß					
Kundenseitig	Kundenseitig					









 Fuß / Position  
 Foot / Position  
 Pied / Positie  
 Piedi / Posizione

 Horn / Posizione  
 Pied / Position  
 Pie / Posición  
 Ayak / Pozisyon



<b>A</b> Höhe 120/150	<b>B</b> Höhe 120/150	<b>C</b> Höhe 120/150	<b>D</b> Höhe 120/150	<b>E</b> Höhe 120/150	<b>F</b> Höhe 120/150	<b>Modellnummer</b> 2285-86/2292-95/2302-05
						<b>Stand</b> 26.01.2023
701/722/274/275	728/729/191/365	627/638	508/698	621/622	635/618/893/192	<b>Revision</b> 16
Werkseitig	Werkseitig	Kundenseitig	Werkseitig	Kundenseitig	Kundenseitig	<b>Verfasser</b> IKR

1	2	3	4	5	6	7	8	9	10			Seite 5 - 6
---	---	---	---	---	---	---	---	---	----	---	---	-------------

<b>G</b> Höhe 120/150	<b>H</b> Höhe 120/150	<b>I</b> Höhe 120/150	<b>J</b> Höhe 120/150	<b>K</b> Höhe 120/150	<b>L</b> Höhe 120/150
					
636/637/866/870	877/878	875/876	841/873/862/863	251/253/252/254	846/872/871/864
Kundenseitig	Kundenseitig	Kundenseitig	Kundenseitig	Kundenseitig	Kundenseitig
<b>M</b> Höhe 120/150	<b>N</b> Höhe 120/150	<b>O</b> Höhe	<b>P</b> Höhe	<b>Q</b> Höhe	<b>R</b> Höhe
					
867/868	Stützfuß				
Kundenseitig	Kundenseitig				

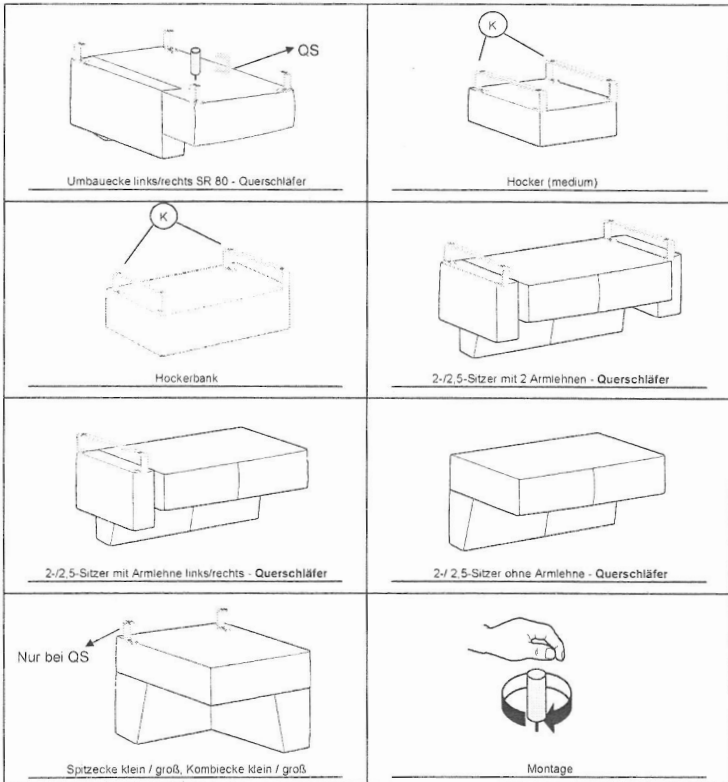

<b>A</b> Höhe 120/150	<b>B</b> Höhe 120/150	<b>C</b> Höhe 120/150	<b>D</b> Höhe 120/150	<b>E</b> Höhe 120/150	<b>F</b> Höhe 120/150	<b>Modellnummer</b> 2285-86/2292-95/2302-05
						<b>Stand</b> 26.01.2023
701/722/274/275	728/729/191/365	627/638	506/698	621/622	635/618/893/192	<b>Revision</b> 16
Werkseitig	Werkseitig	Kundenseitig	Werkseitig	Kundenseitig	Kundenseitig	<b>Verfasser</b> IKR

1	2	3	4	5	6	7	8	9	10		Seite 6 - 6
---	---	---	---	---	---	---	---	---	----	--	-------------

<b>G</b> Höhe 120/150	<b>H</b> Höhe 120/150	<b>I</b> Höhe 120/150	<b>J</b> Höhe 120/150	<b>K</b> Höhe 120/150	<b>L</b> Höhe 120/150	
636/637/859/870	877/878	875/876	841/873/862/863	251/253/252/254	846/872/871/864	
Kundenseitig	Kundenseitig	Kundenseitig	Kundenseitig	Kundenseitig	Kundenseitig	
<b>M</b> Höhe 120/150	<b>N</b> Höhe 120/150	<b>O</b> Höhe	<b>P</b> Höhe	<b>Q</b> Höhe	<b>R</b> Höhe	
867/868	Stützfuß					
Kundenseitig	Kundenseitig					

30.11.2011

Stand

00

Revision

VHÖ

Verfasser

1 / 1

Seite(n)

Bedienungsanleitung Elementverbinder

Bezeichnung

FOB\_MO\_0004

lfd. Nr.

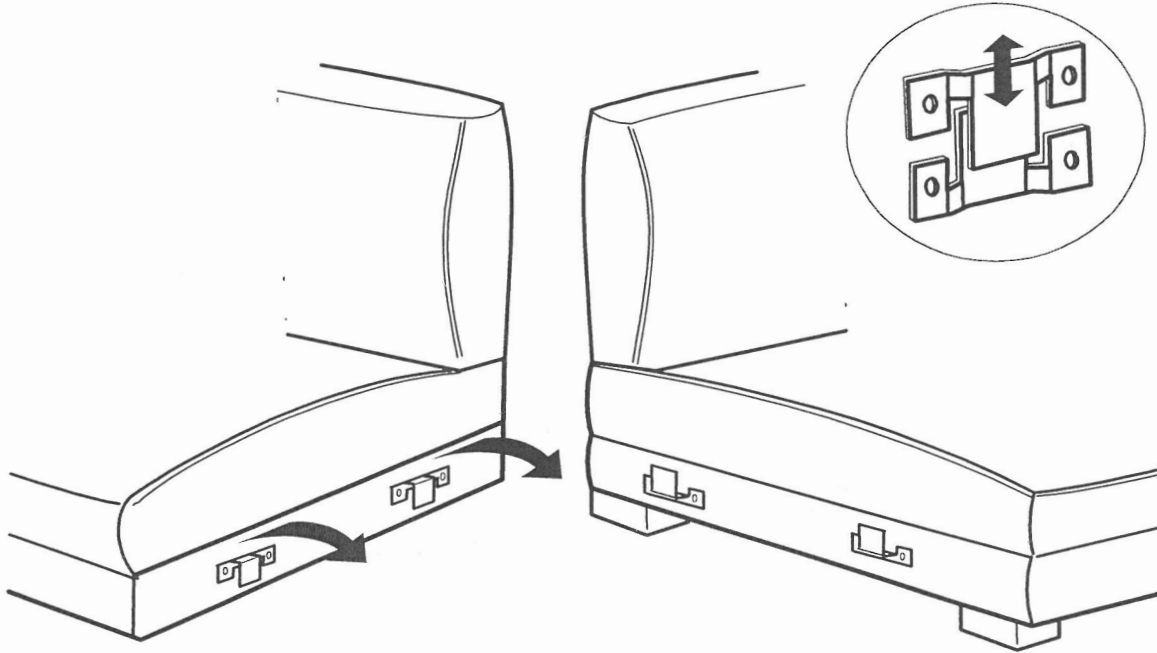

25.03.2013

Stand

00

Revision

APO

Verfasser

1 / 1

Seite(n)

höhenverstellbarer Stützfuß

Bezeichnung

FOB\_MO\_0011

lfd. Nr.

1

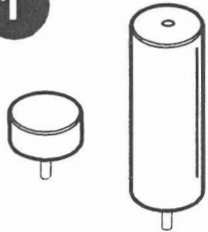

2

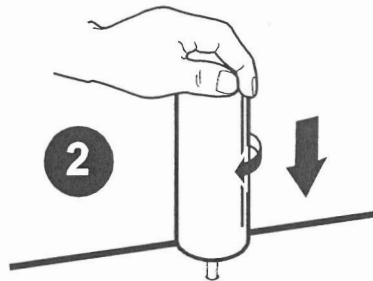

3

