

Have Your attention

- (1) Do not tighten the screws until making sure all the screws are lining up with the holes, otherwise some screws may not line up with the holes
- (2) If this situation occurs during assembly, please loosen the screws which have been tightened, make sure all the screws line up with all the holes, tighten a little and then tighten them in diagonal way again.
- (3) If the product is uneven after installation, please loosen the screws, put strength on the frame, make sure all the legs are in the same level and then go on assembling it.

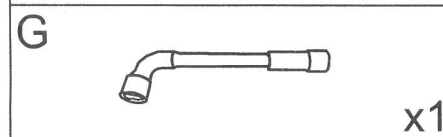

01

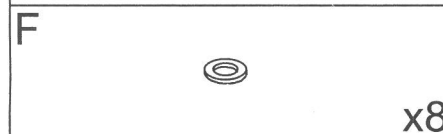
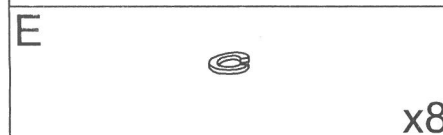
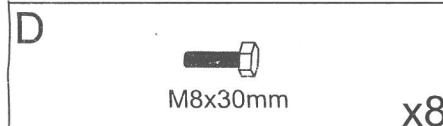
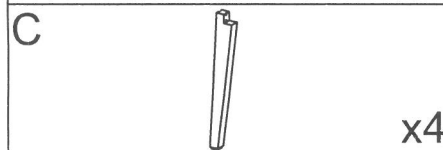
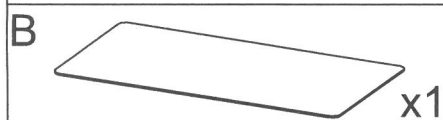
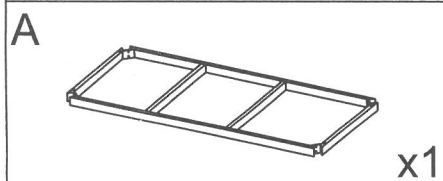
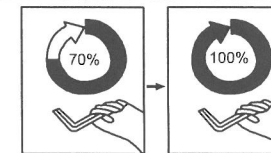
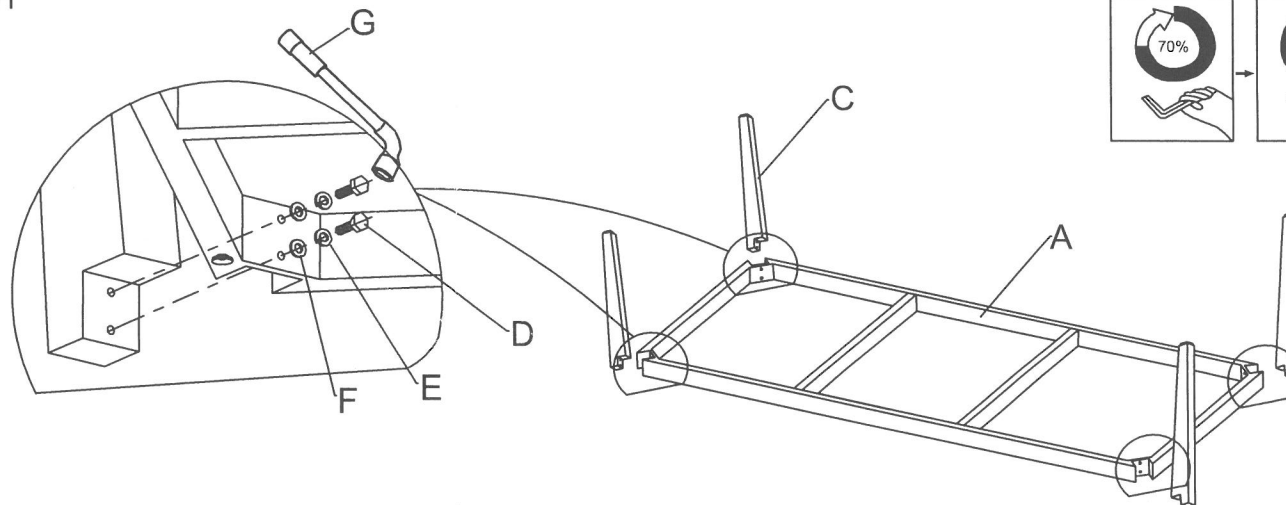

02

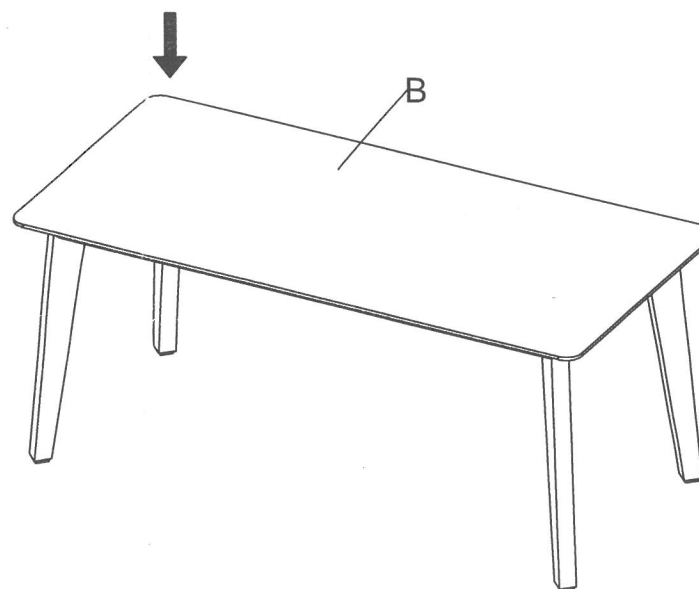

COUTURE
— *Sassia* —