

A	B1	B2	C1	C2	C3	D
1	S577-0013	-2	1326	298	19	2/3
2	S577-0014	-4	1326	546	19	3/3
3	S577-0015	-4	1326	546	19	3/3
4	S577-1007	-5	1296	347	16	2/3
5	S577-1008	-4	1296	347	16	2/3
6	S577-1009	-4	1296	327	16	1/3
7	S577-1010	-5	1296	327	16	1/3
8	S577-2001	-4	1402	347	16	2/3
9	S577-2002	-6	1402	347	16	2/3
10	S577-3001	-2	524	323	16	1/3
11	S577-3002	-3	287	323	16	3/3
12	S577-3003	-2	286	323	16	1/3
13	S577-3006	-3	517	150	6	3/3
14	S577-5011	-2	218	218	15	3/3
15	S577-5501	-4	456	406	4	3/3
16	S577-9008	-3	1306	536	2,5	3/3
17	S577-9009	-2	1306	306	2,5	3/3
18	S577-9010	-3	1306	536	2,5	3/3

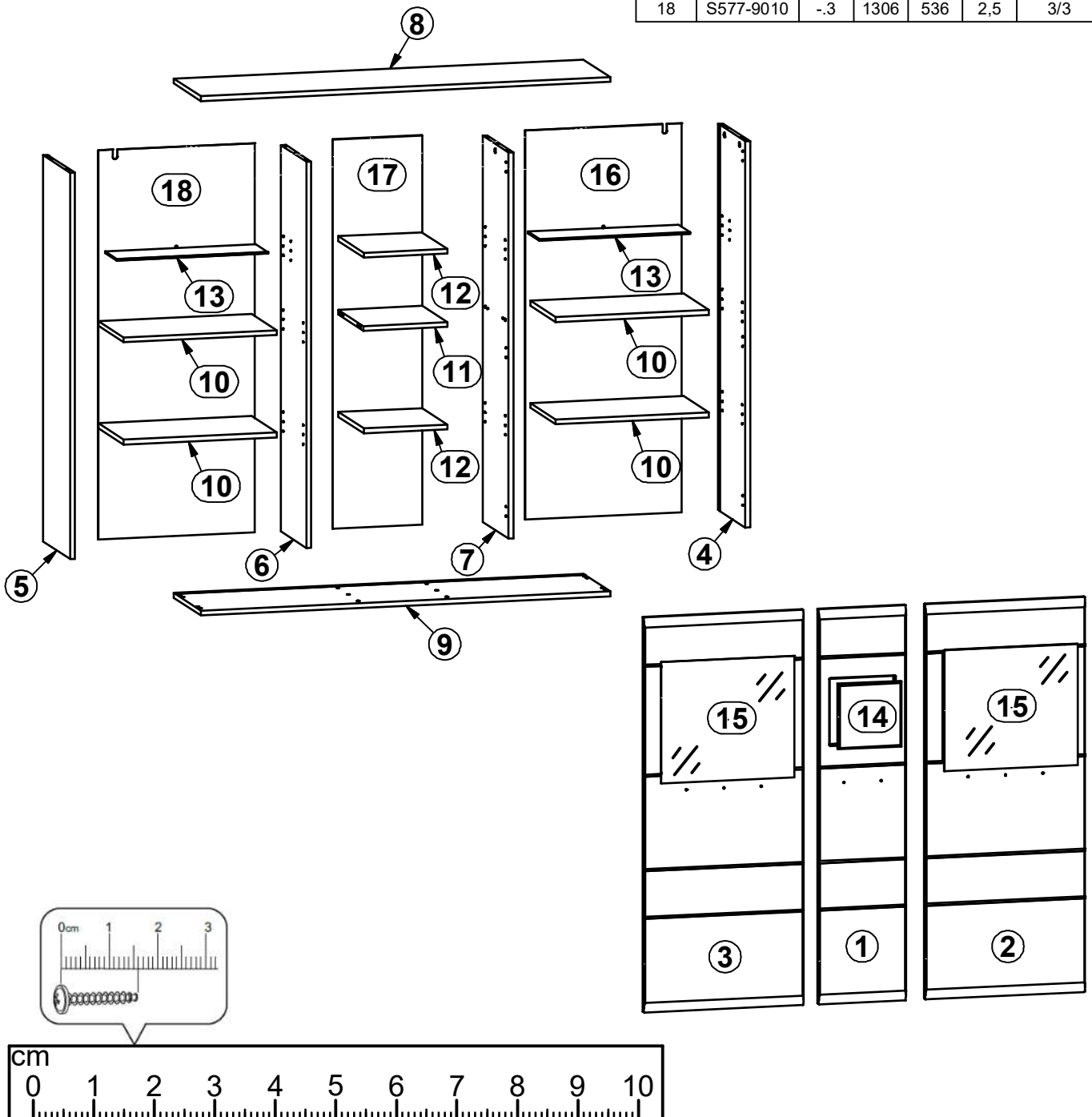

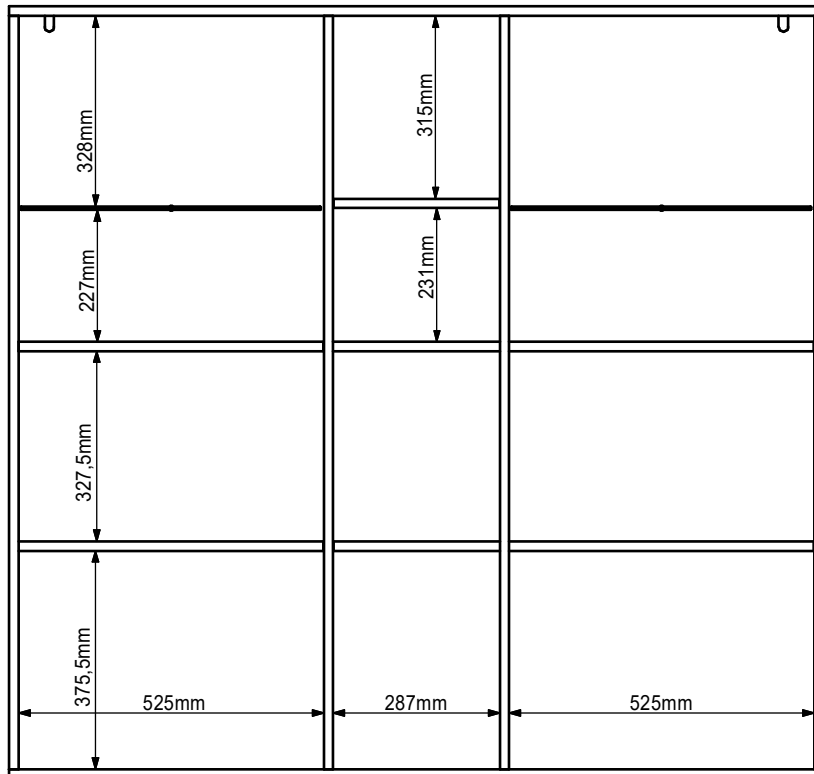

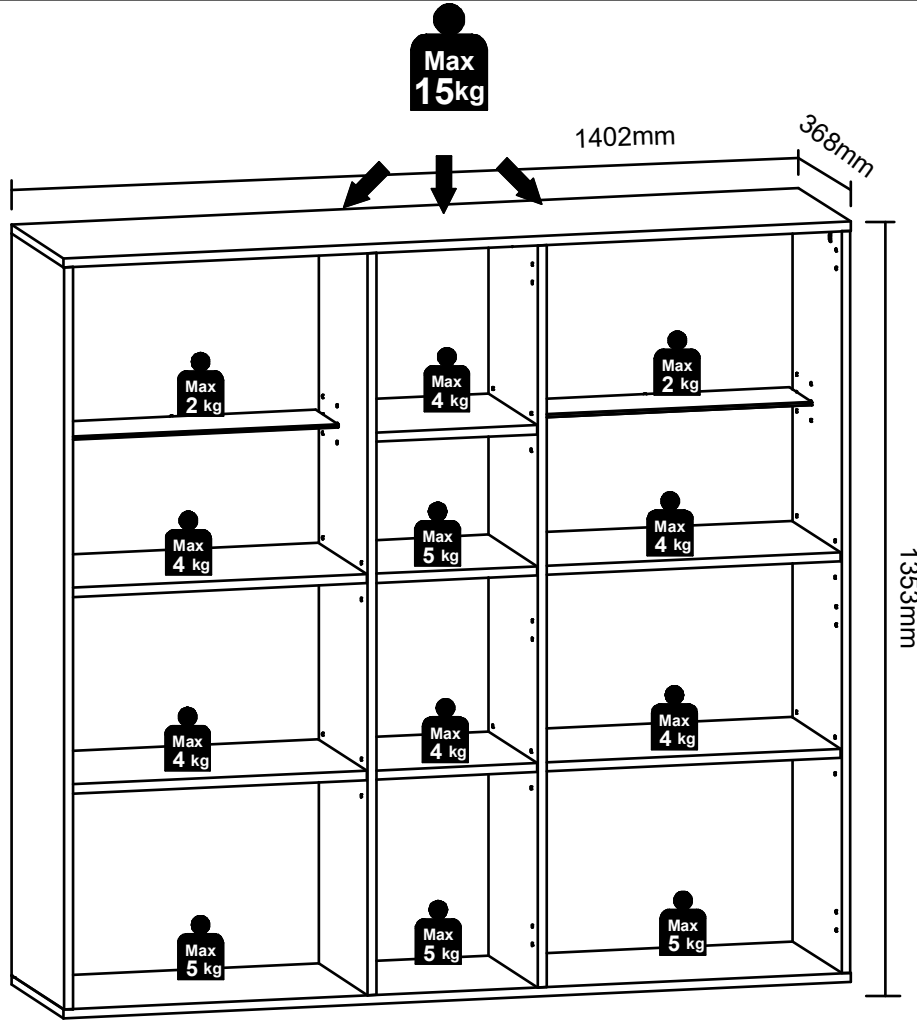
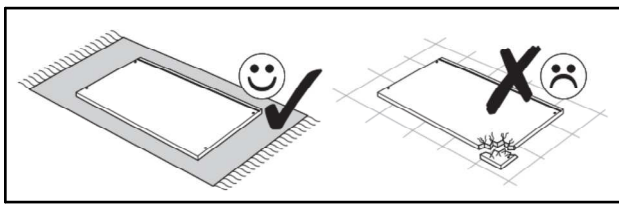

4x Ø15x12 mm #16 r1	4x d38	8x Ø5x17 mm d1	8x Ø8x30 mm f1	6x b90
---------------------------	-----------	----------------------	----------------------	-----------

1 ▶

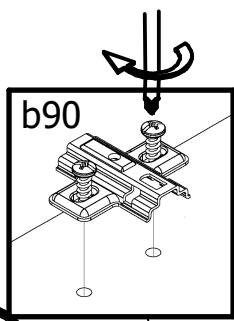
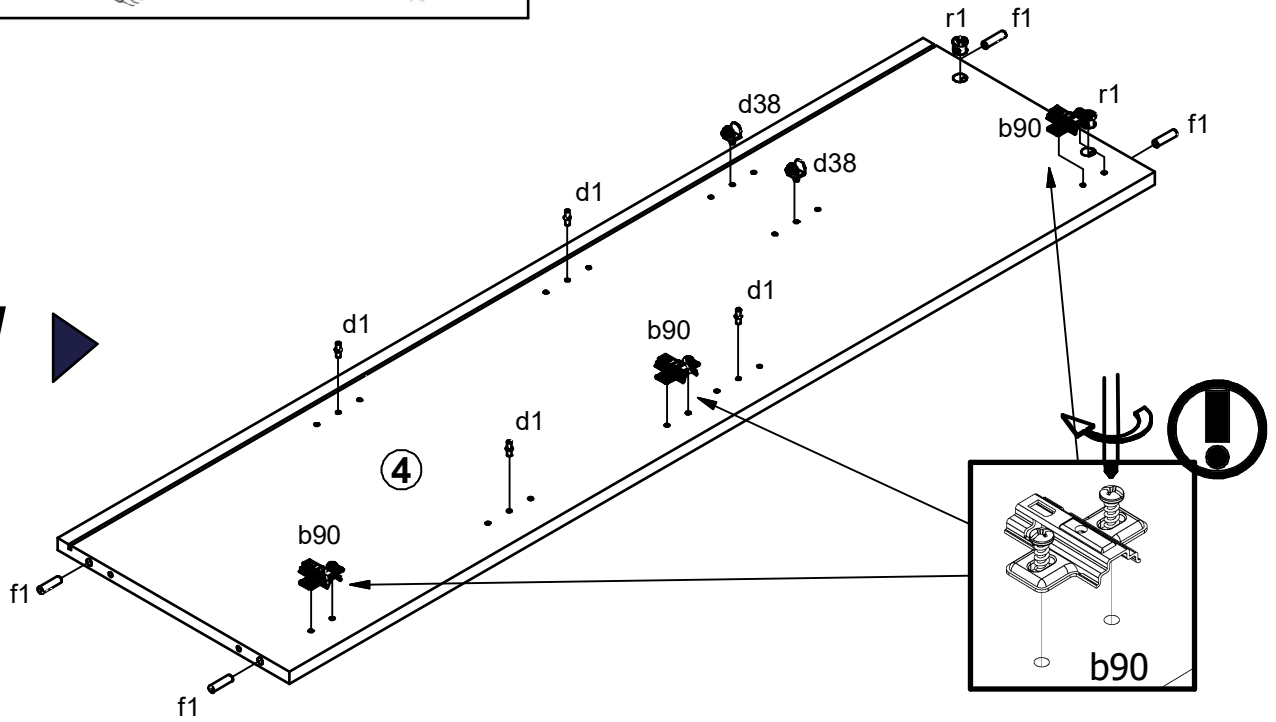

◀ 2

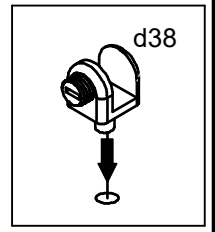
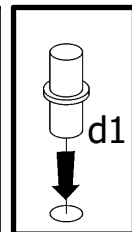
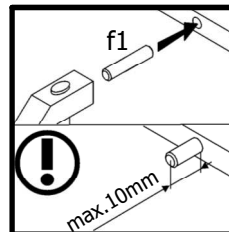
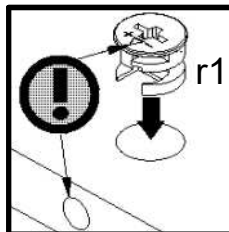
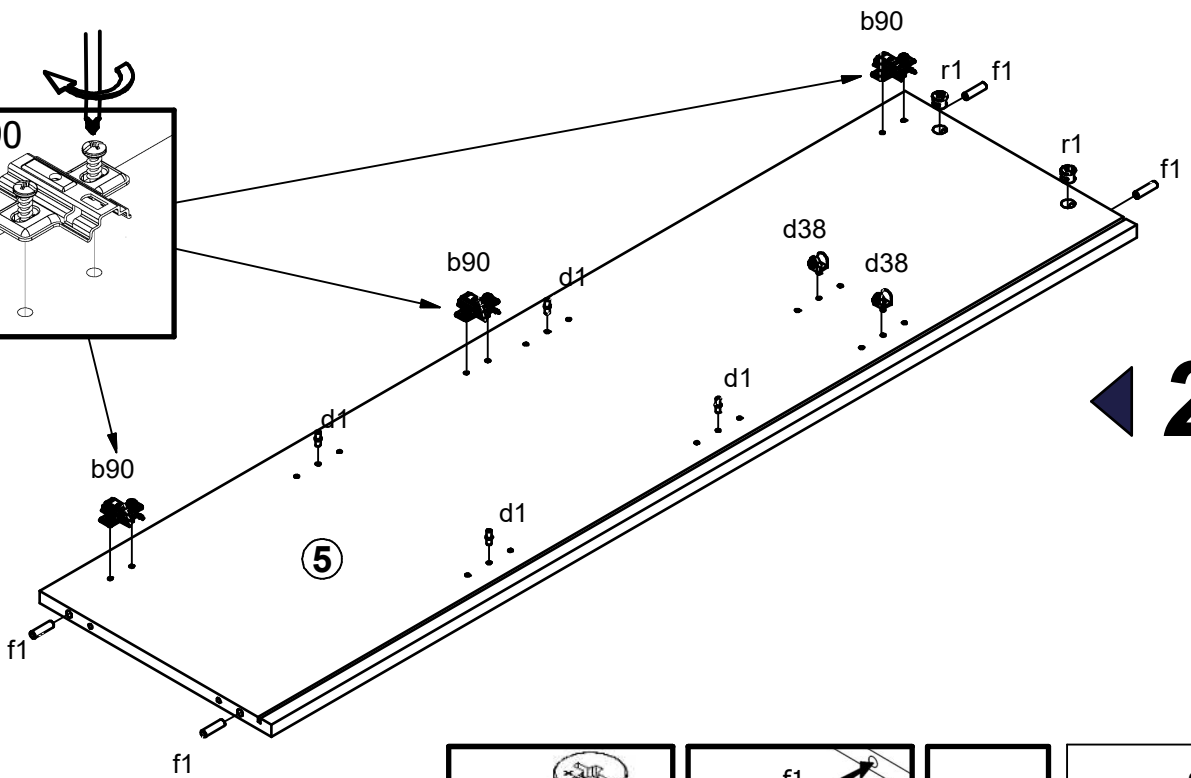

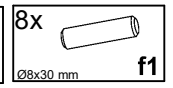
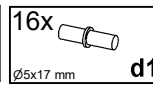
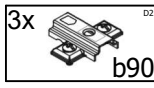
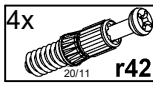
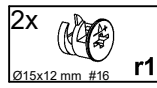
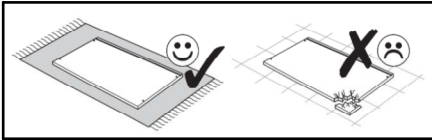
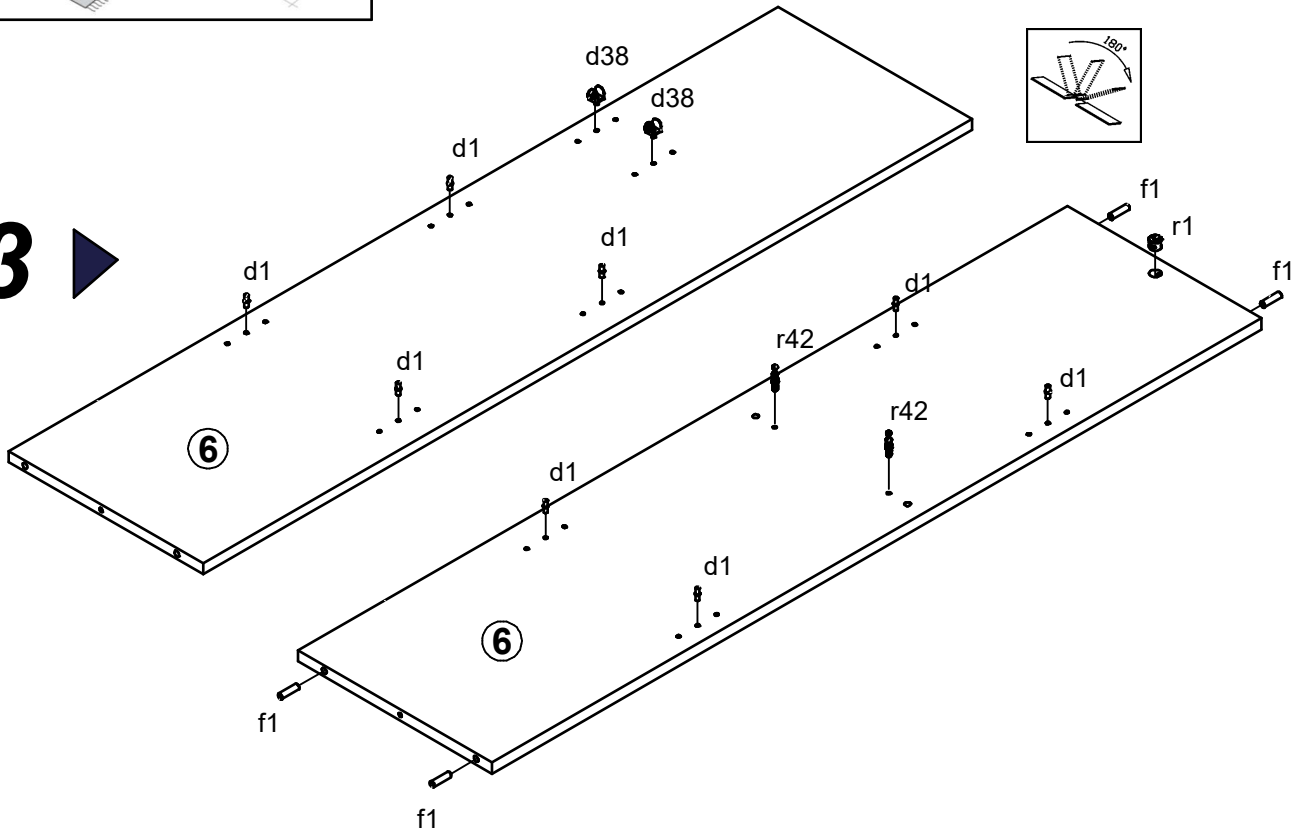
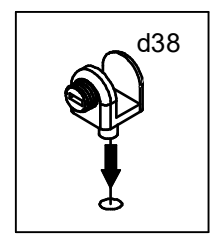
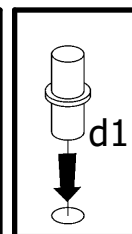
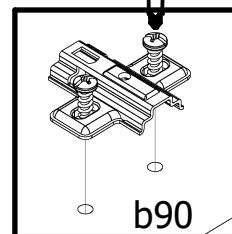
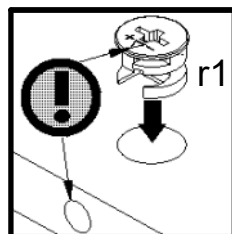
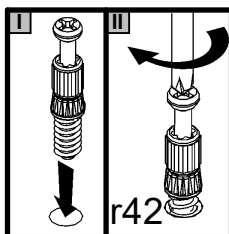
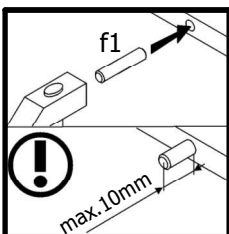
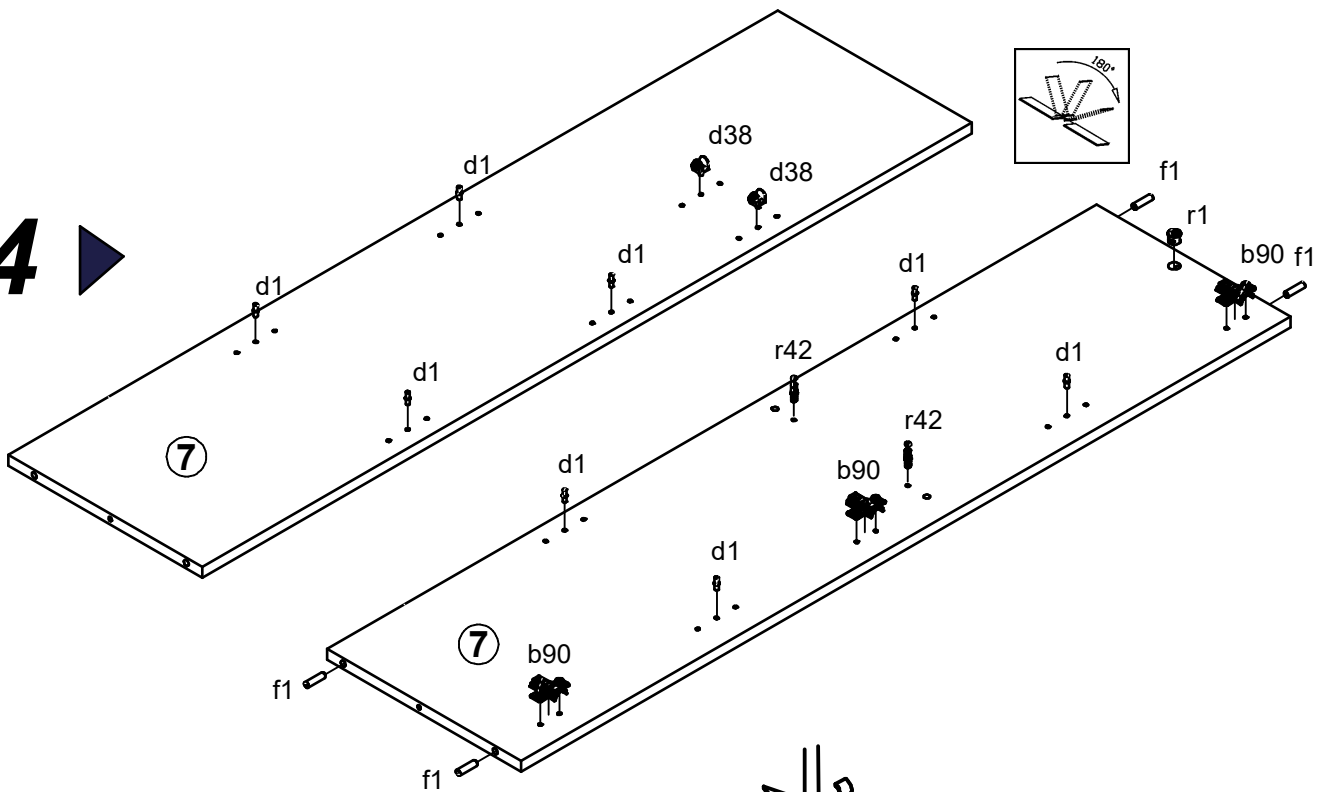
**3** ▶**4** ▶

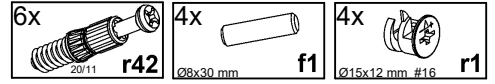
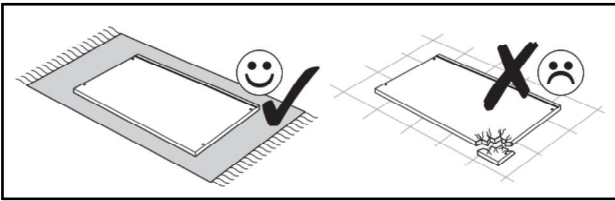

5 ▶

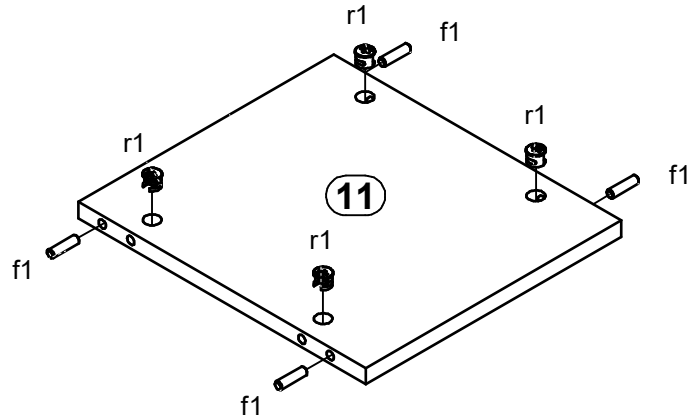

6 ▶

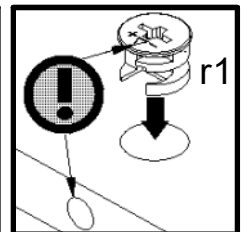
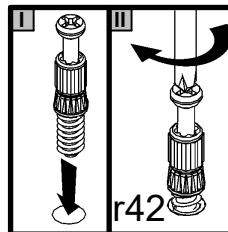
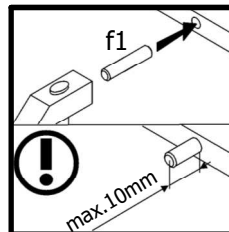
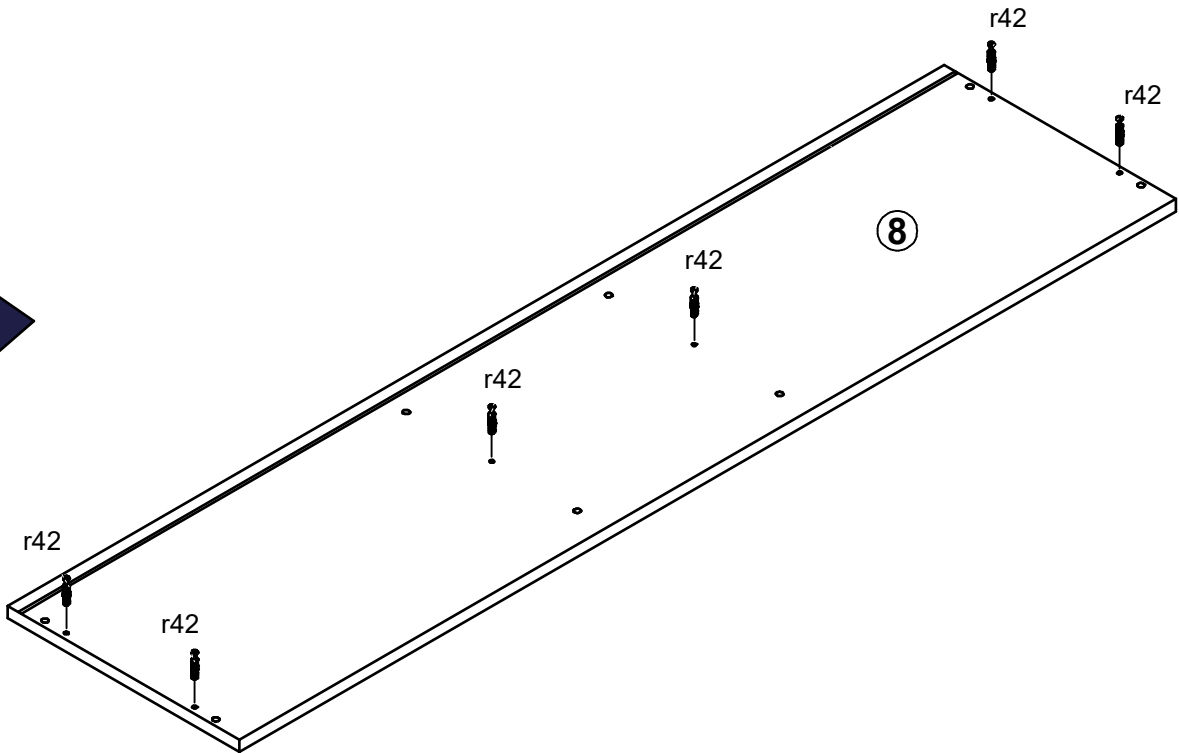

A**S577-REG2W1D****1BE6--22**

7 / 17

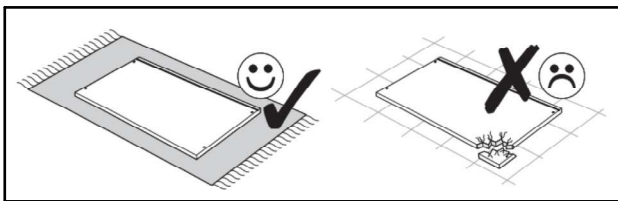

3x a205	6x a204	18x p51 Ø3,5x15 mm	12x p61 Ø3,5x16 mm	12x I3
------------	------------	--------------------------	--------------------------	-----------

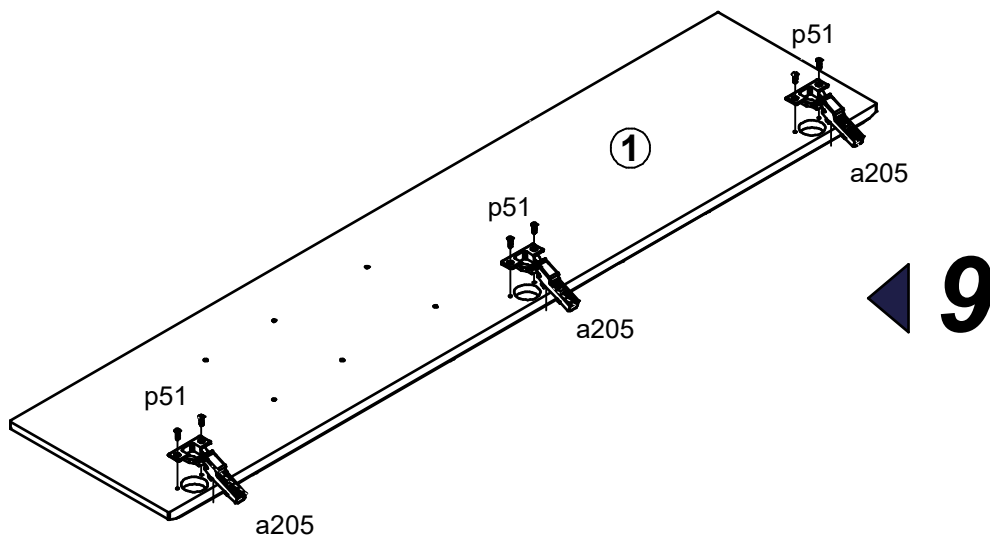
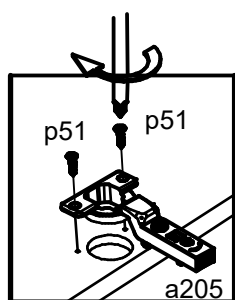
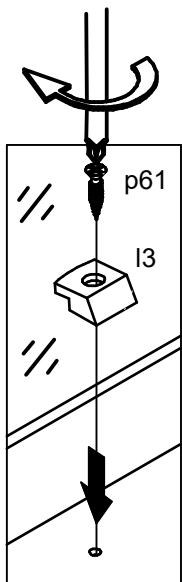
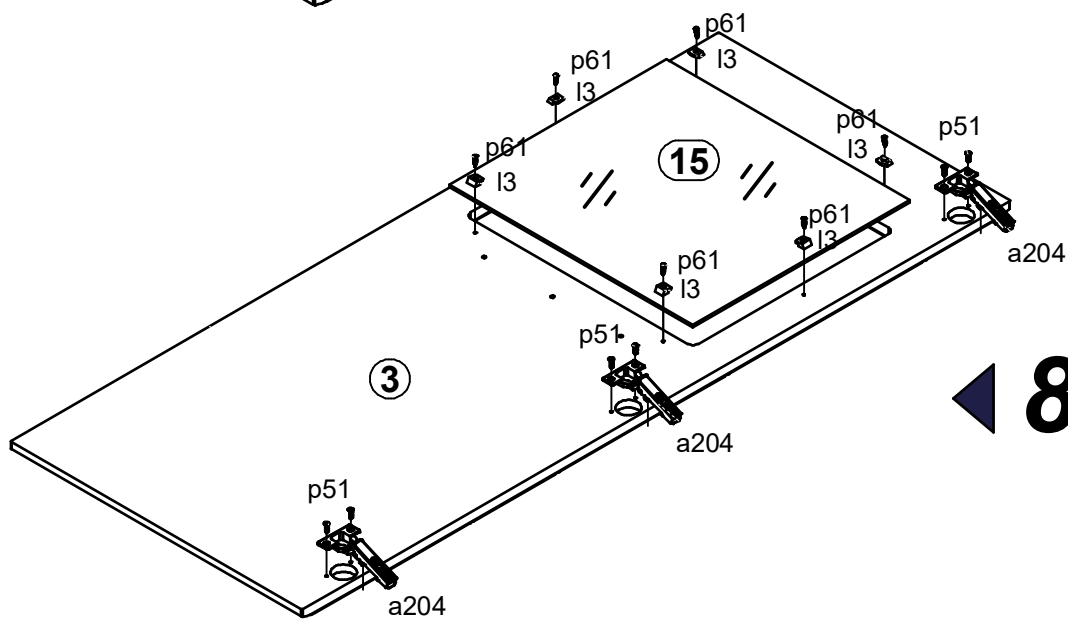
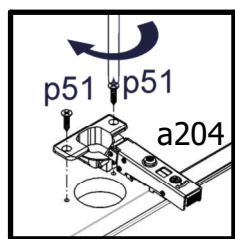
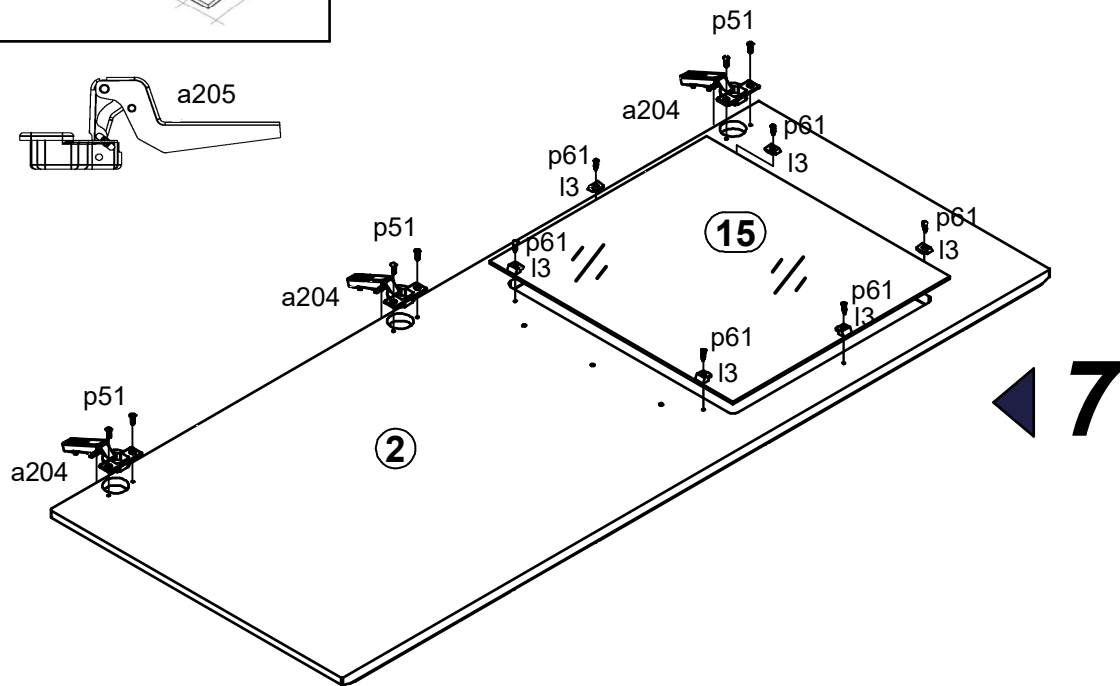
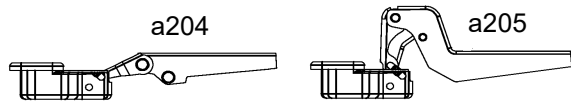

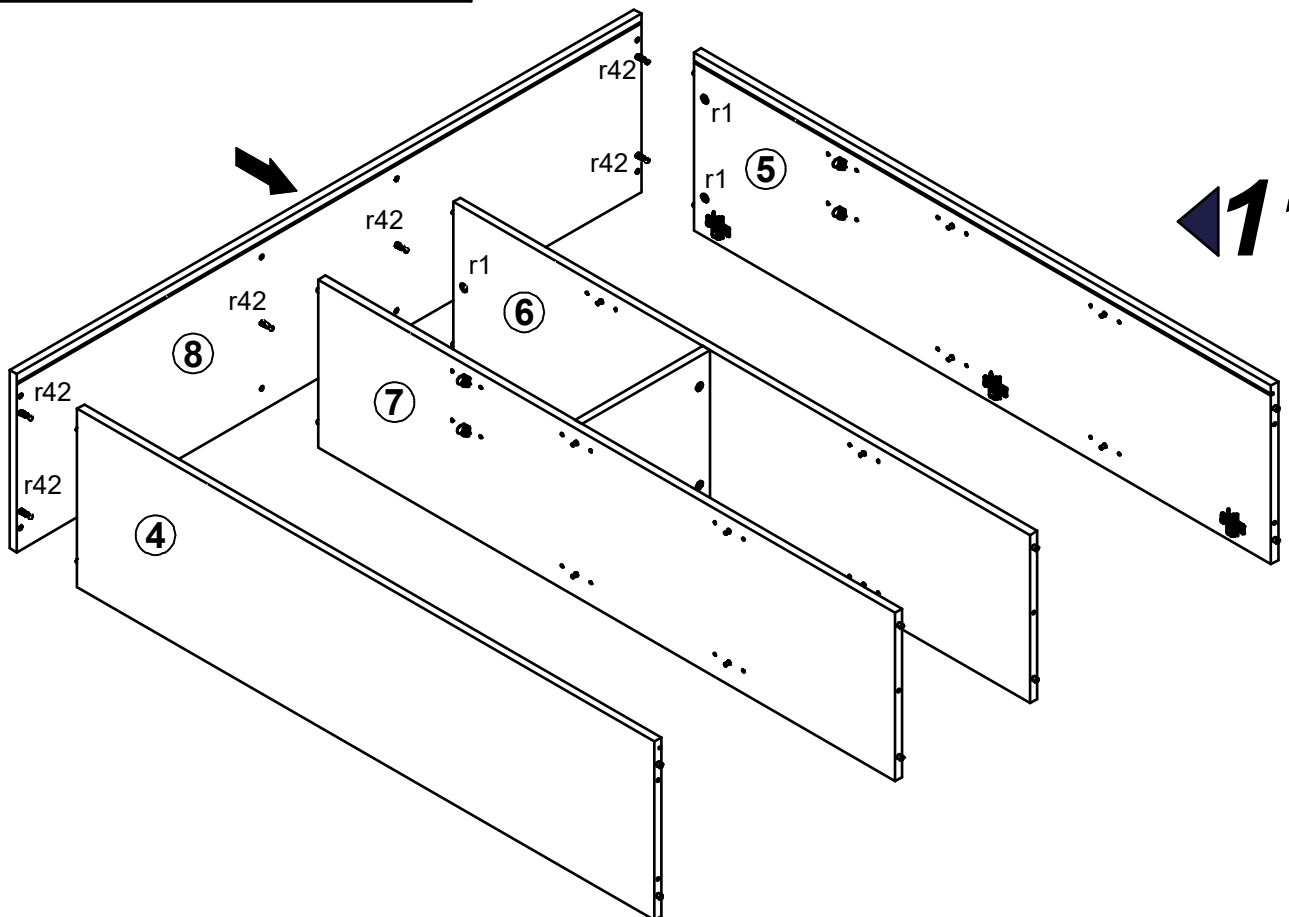
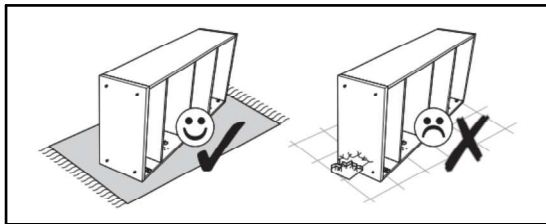
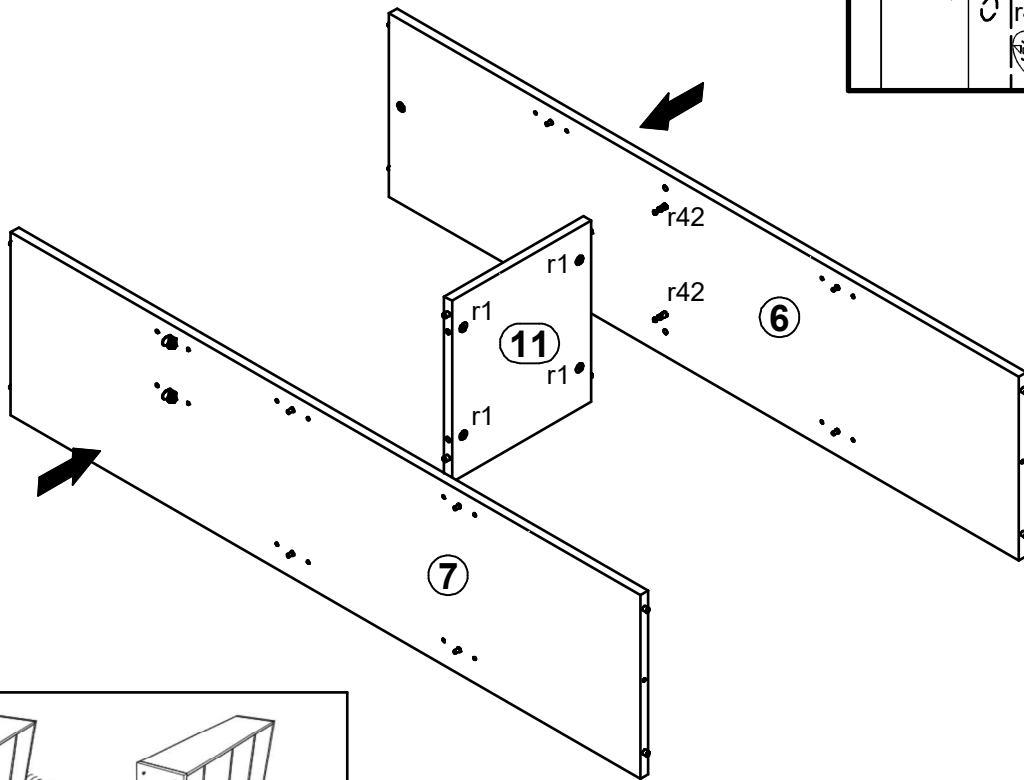
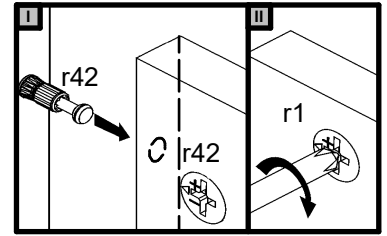

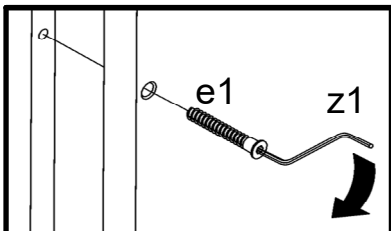
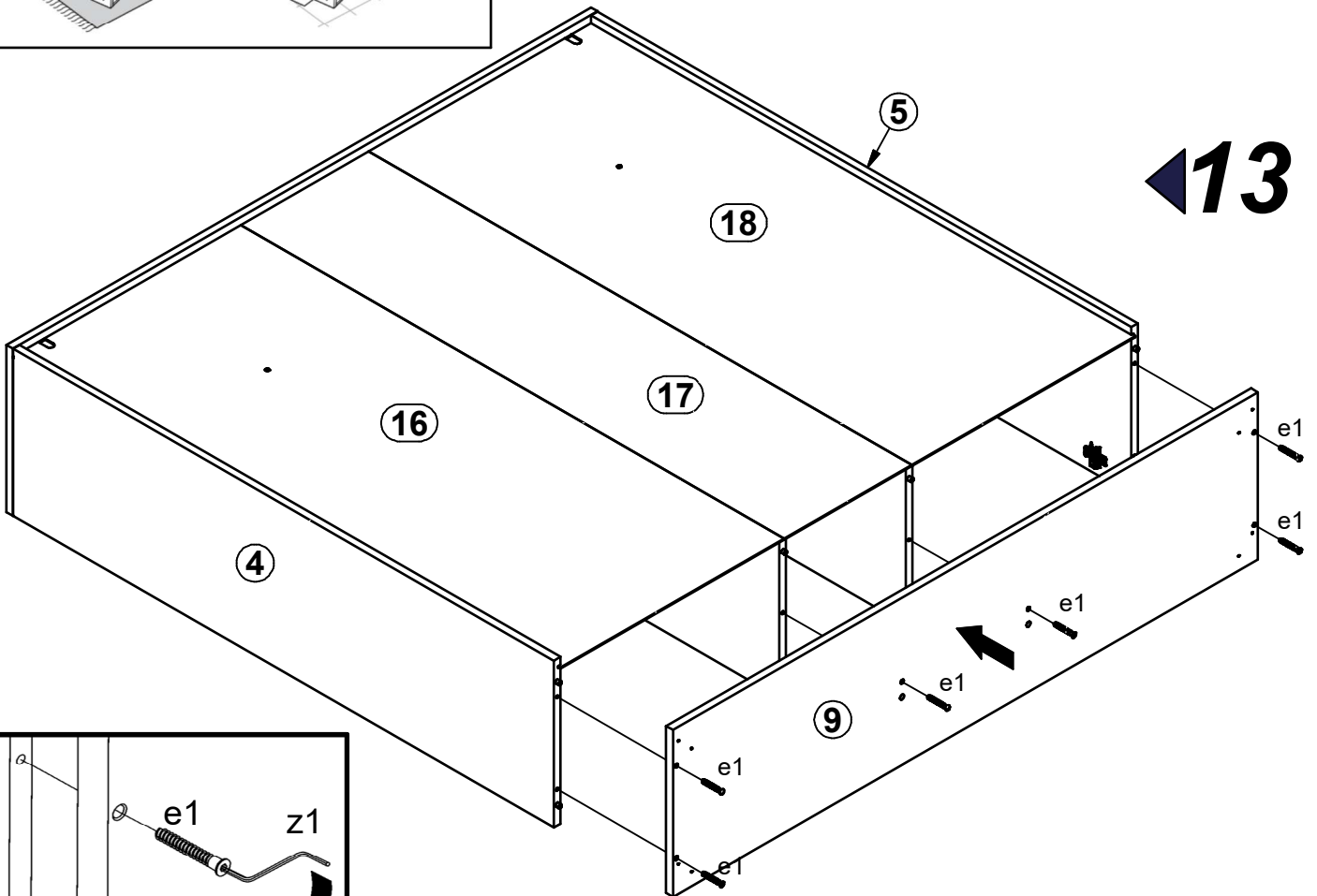
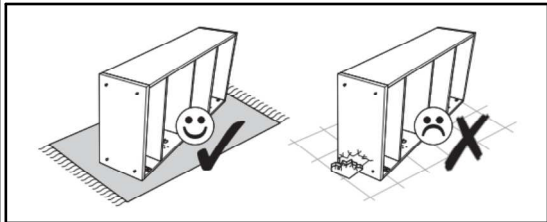
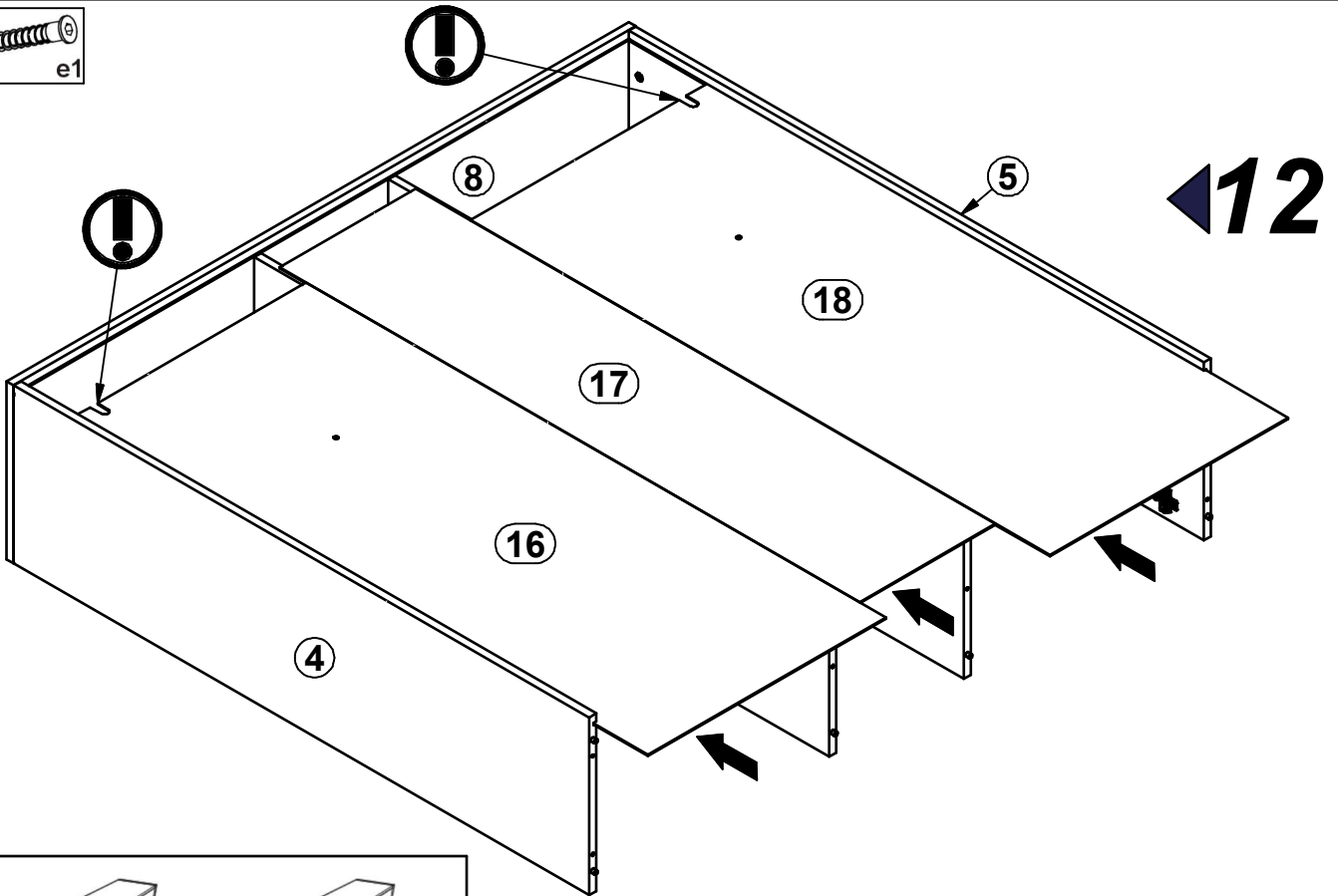
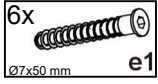

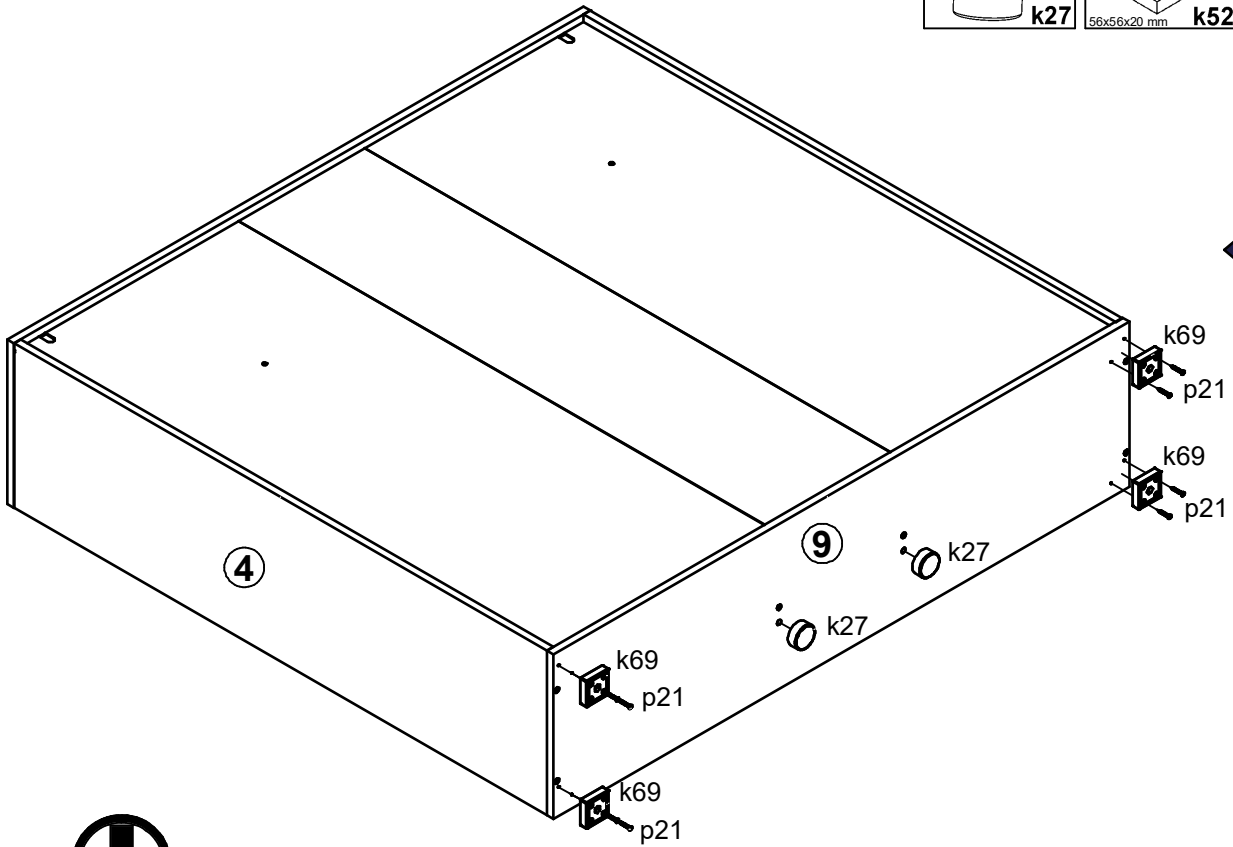
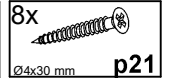
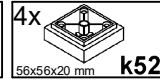
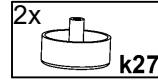

A=B

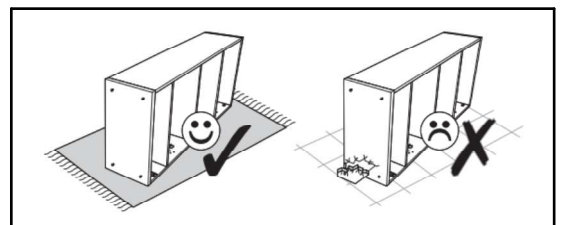
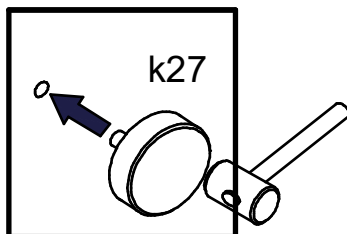
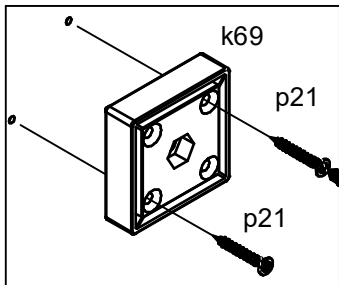
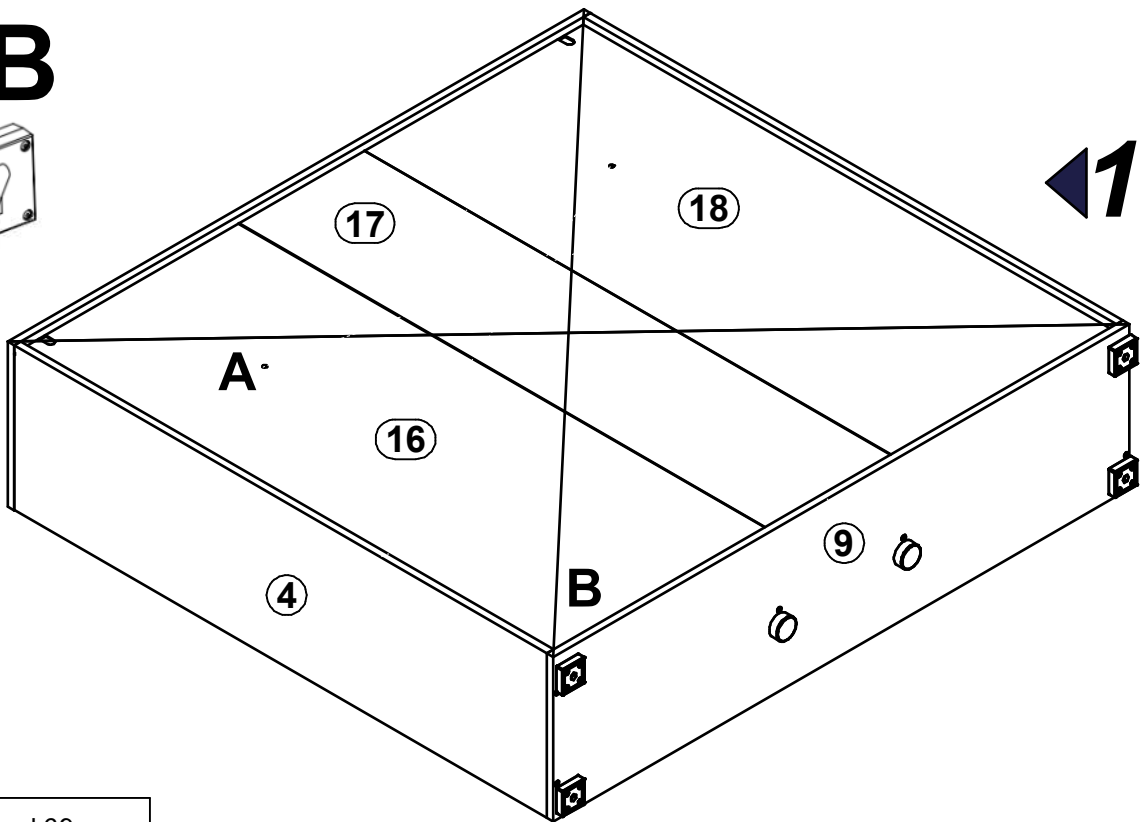
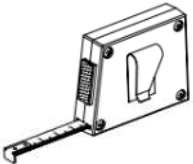

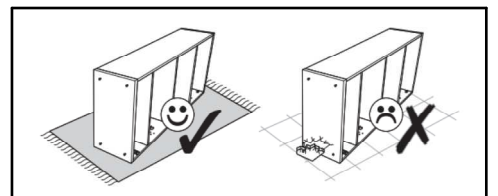
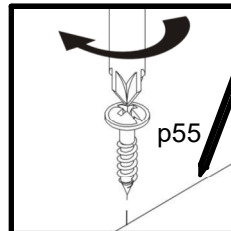
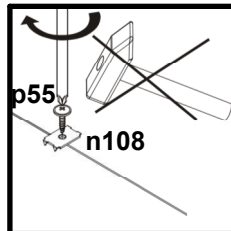
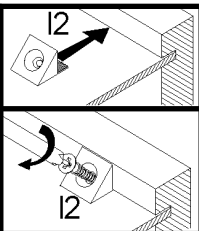
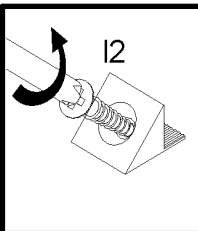
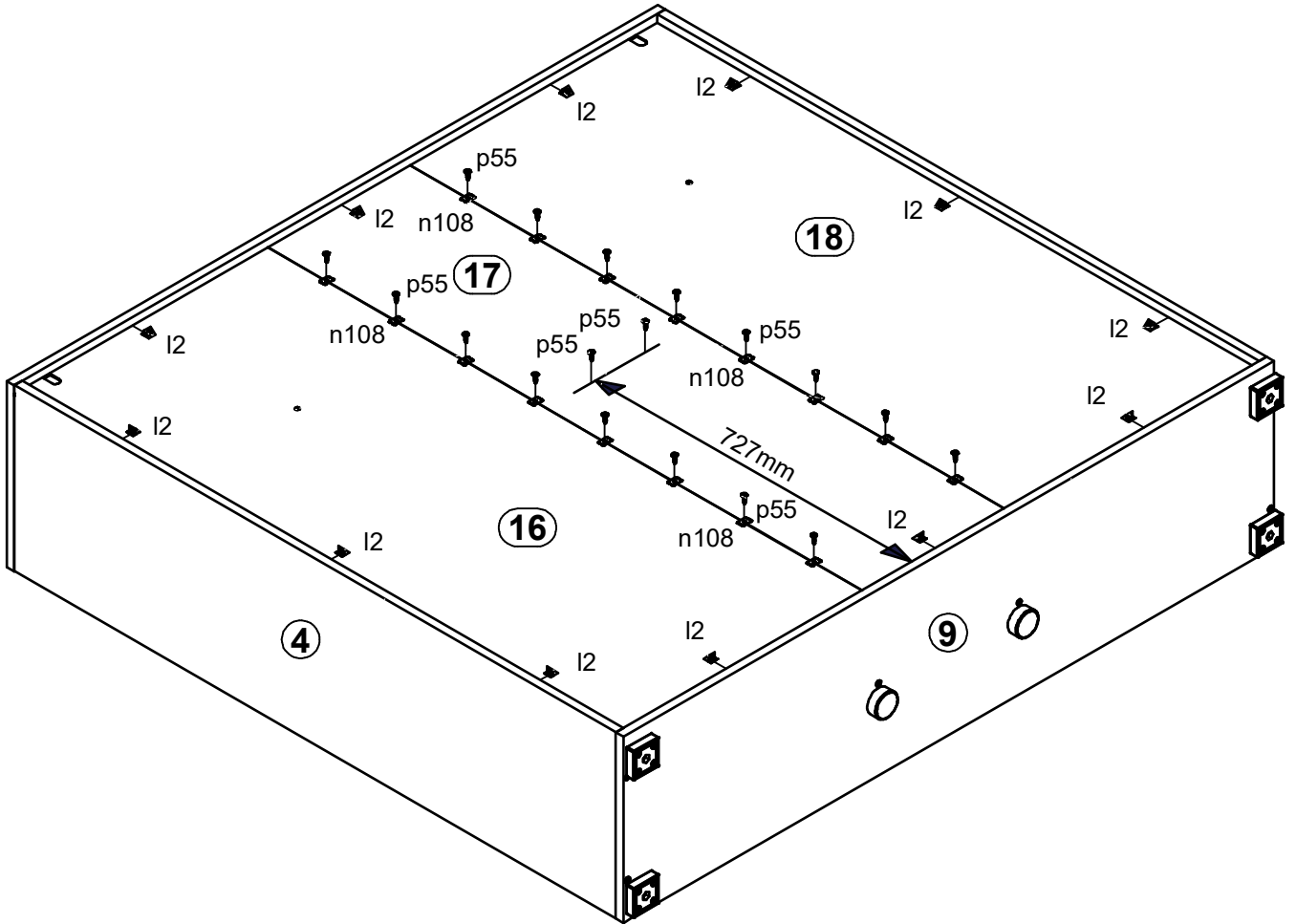
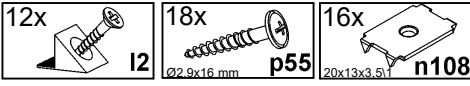

17

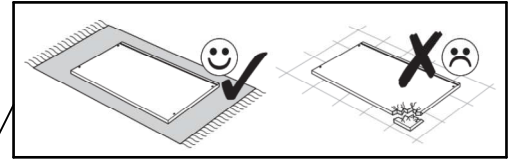
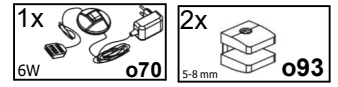
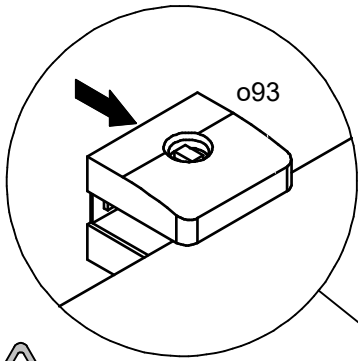

2x

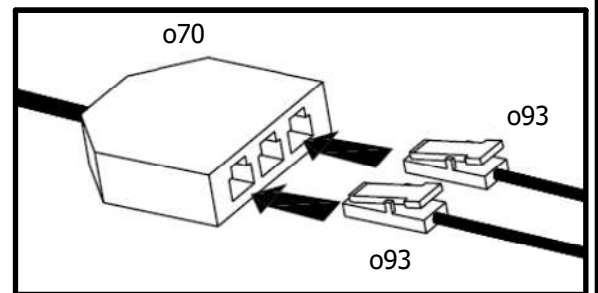
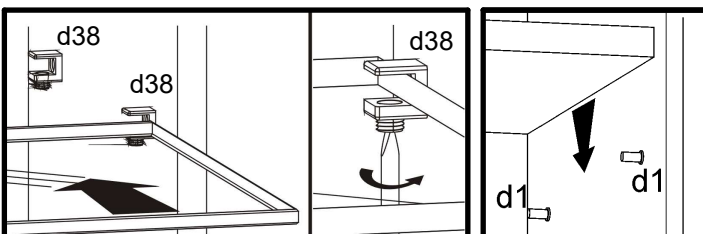
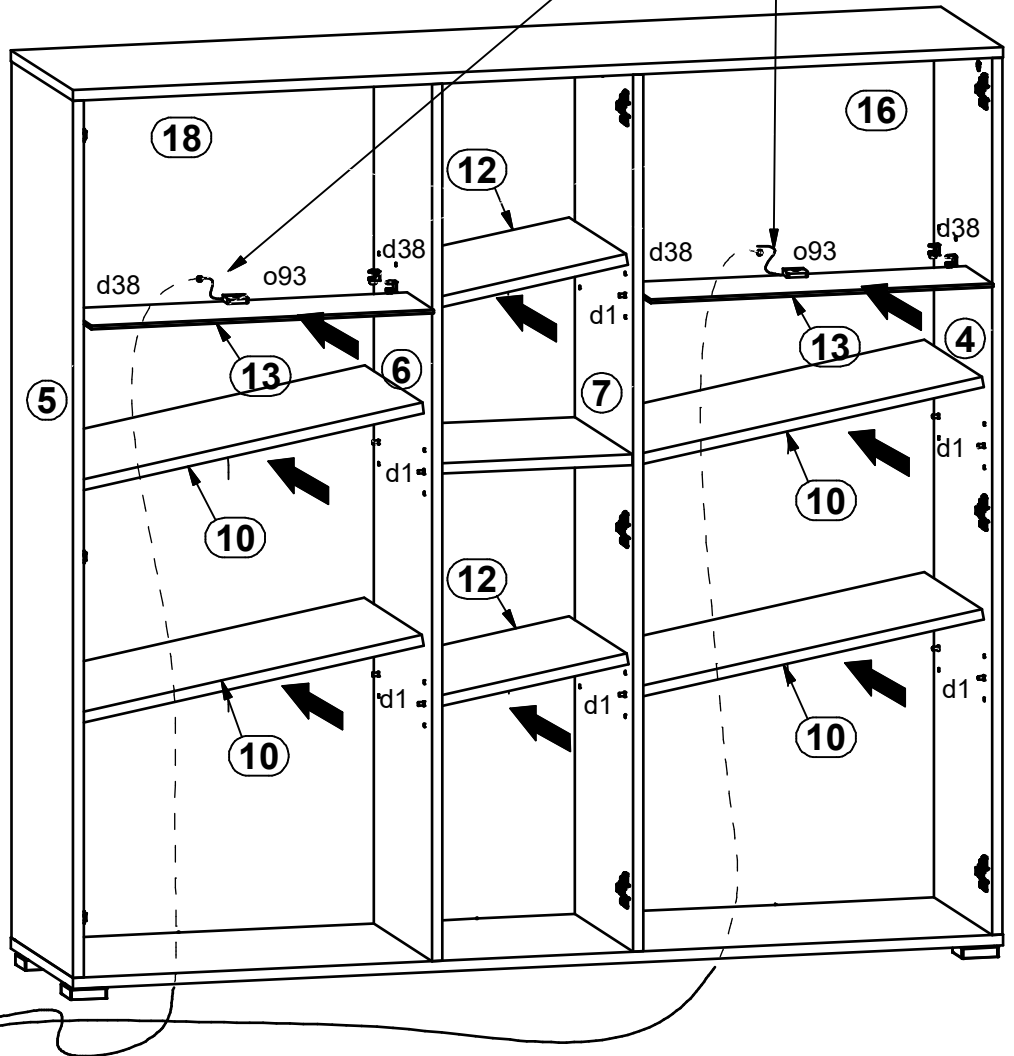
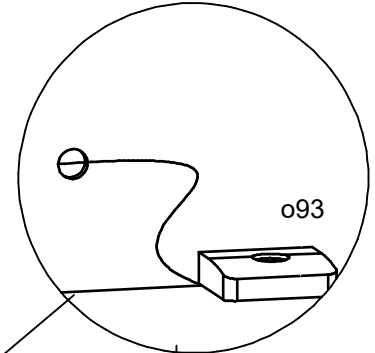
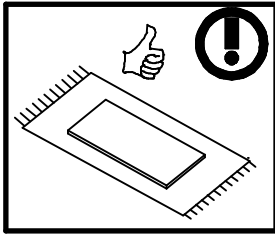

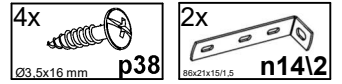
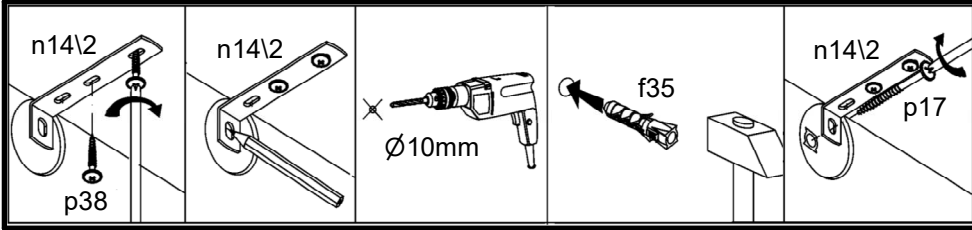

18

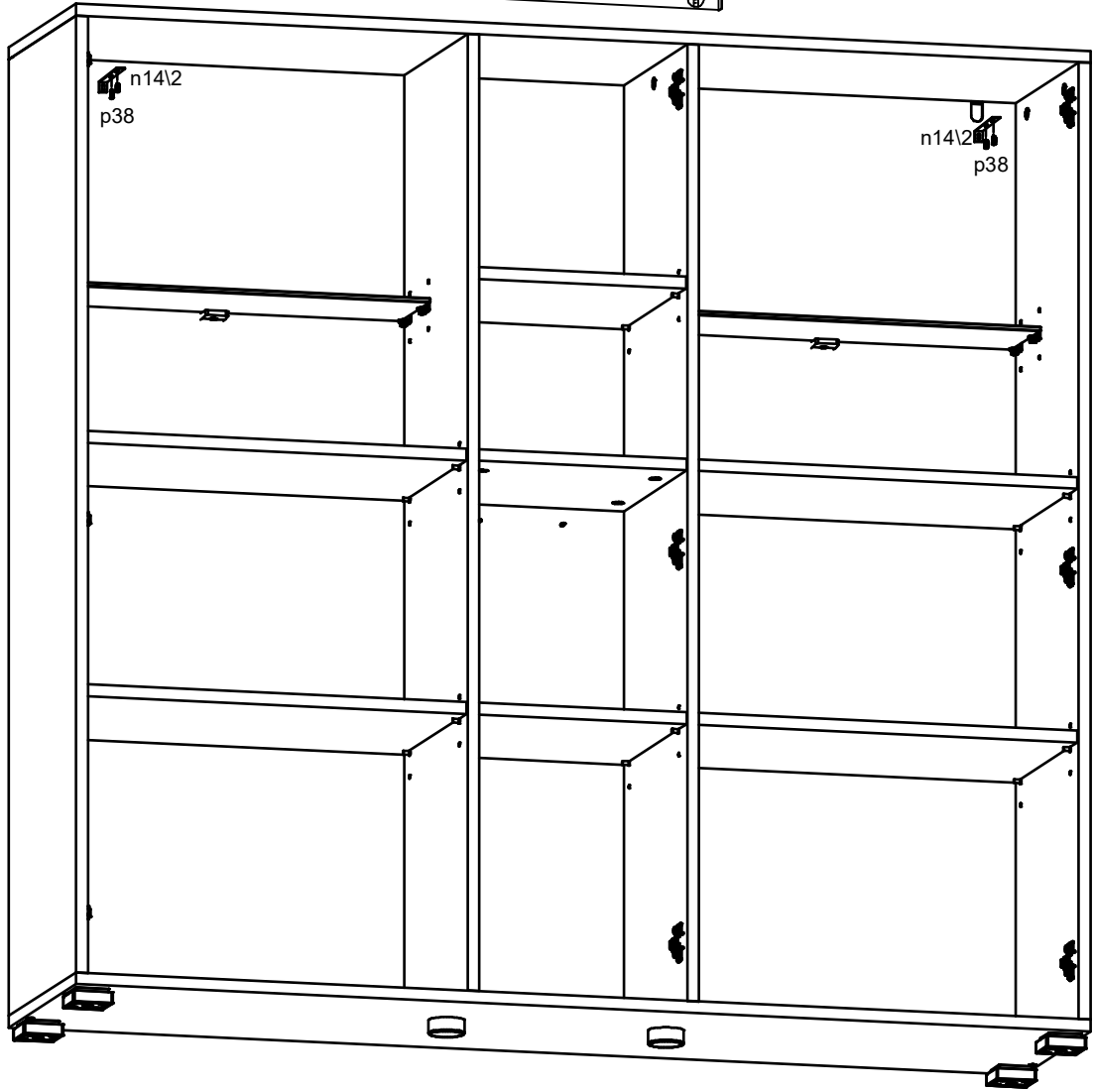
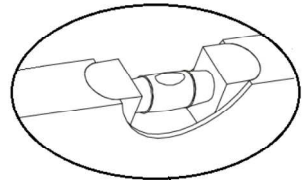
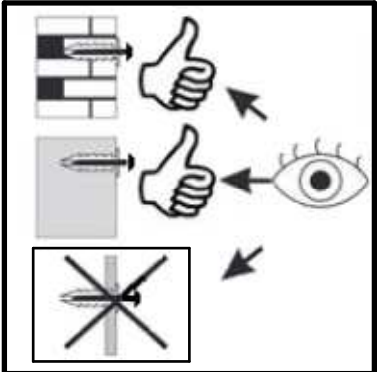
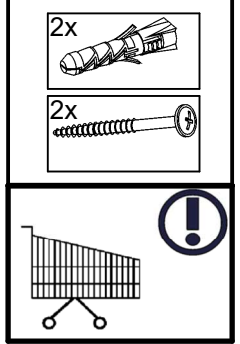

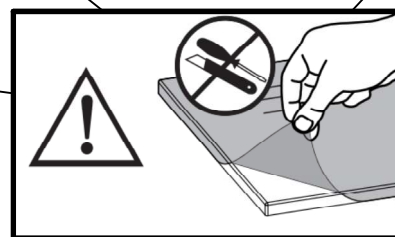
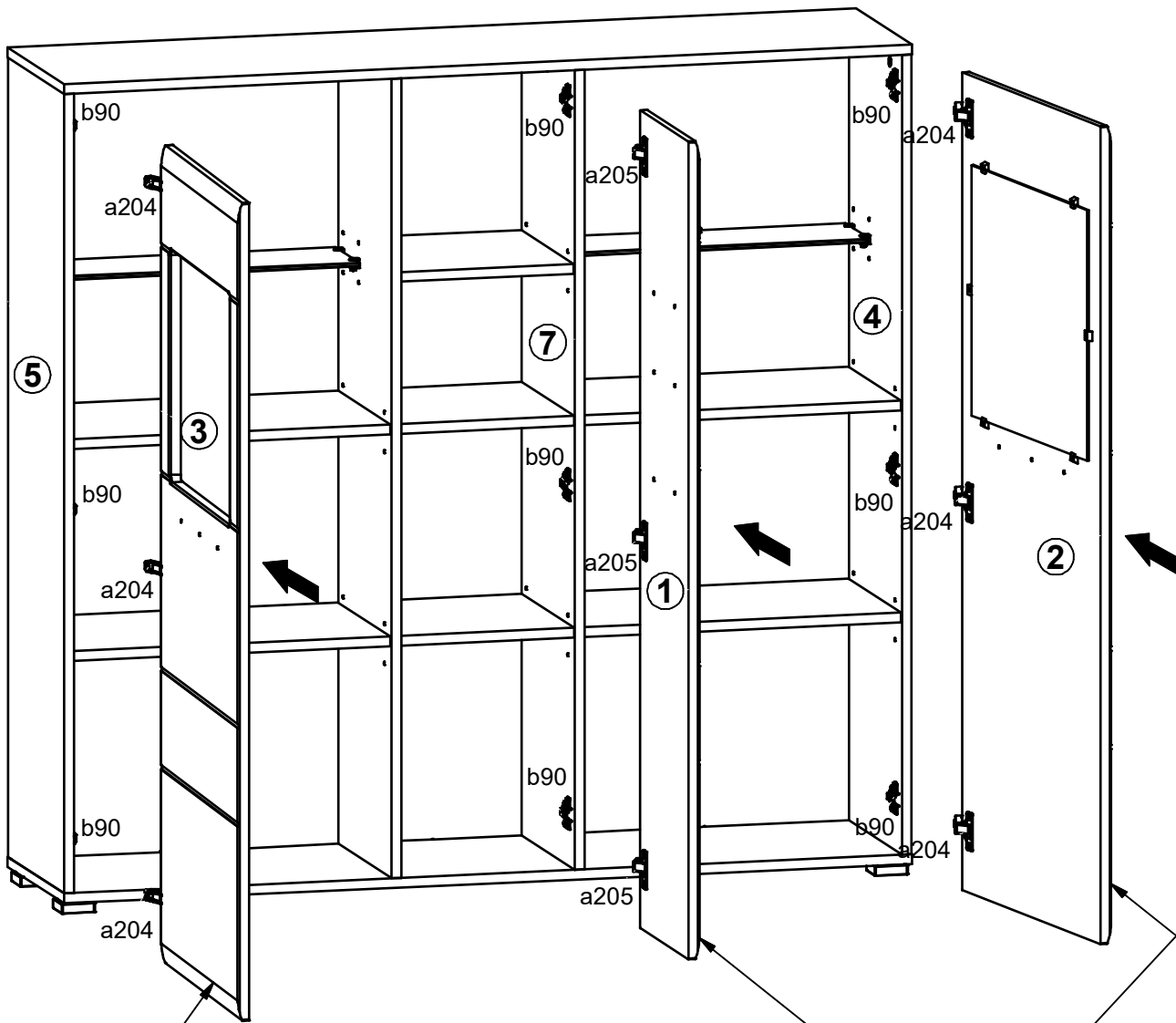
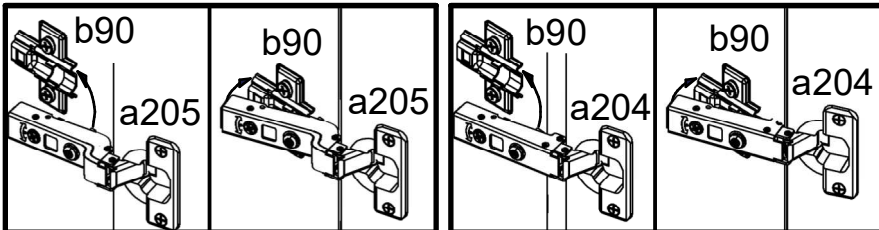

20

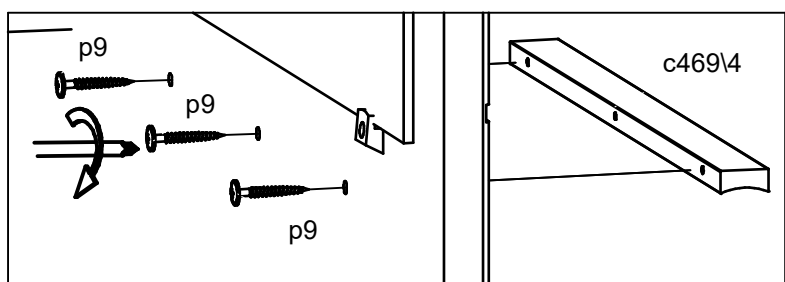
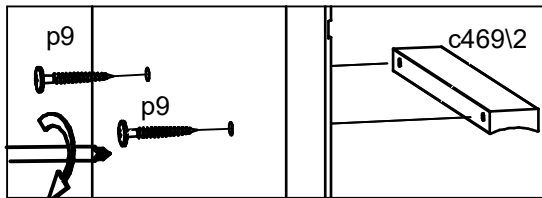
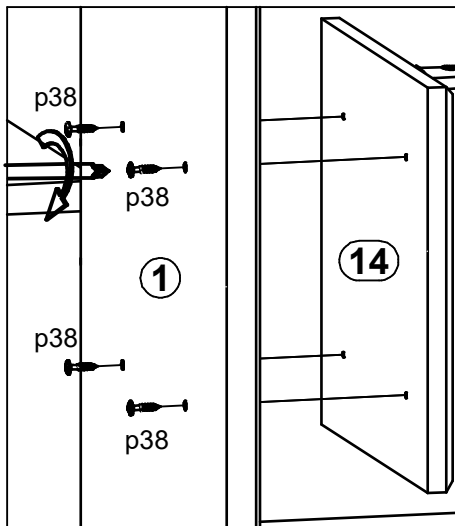
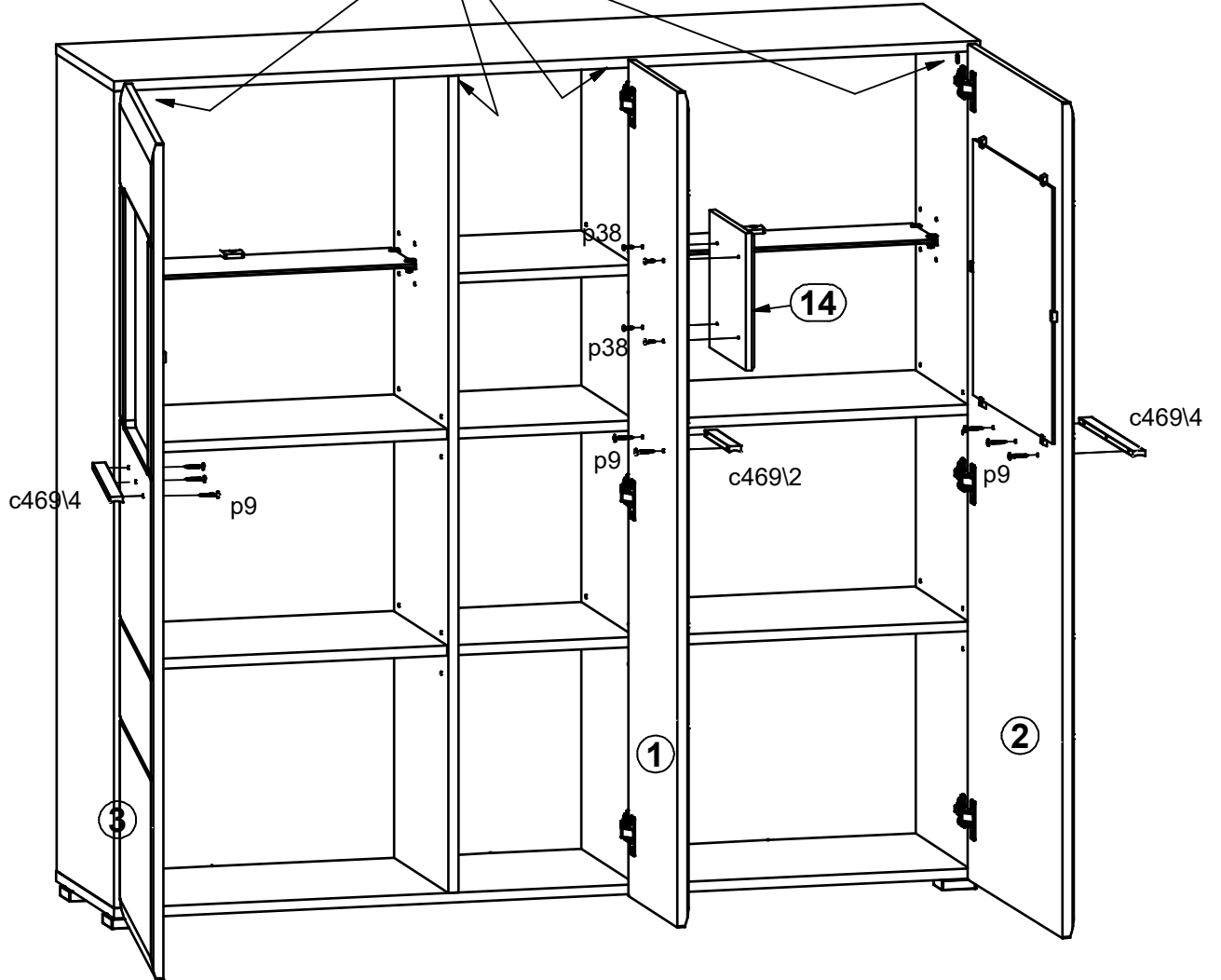
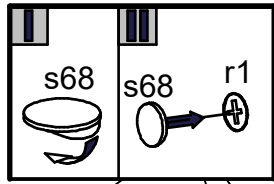
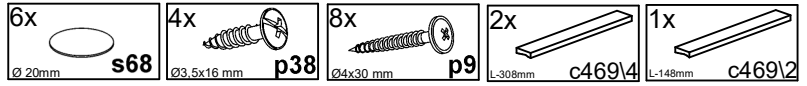

1x HOM'IN
s93\2

21

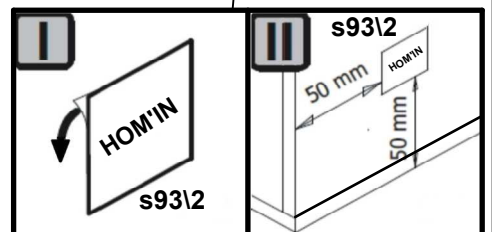
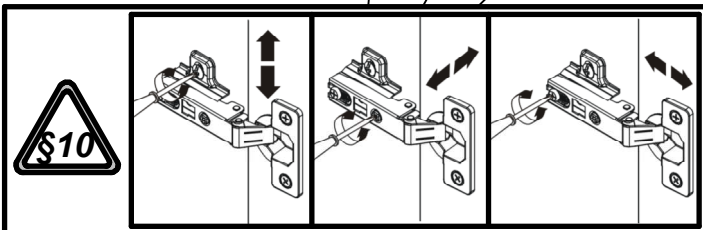
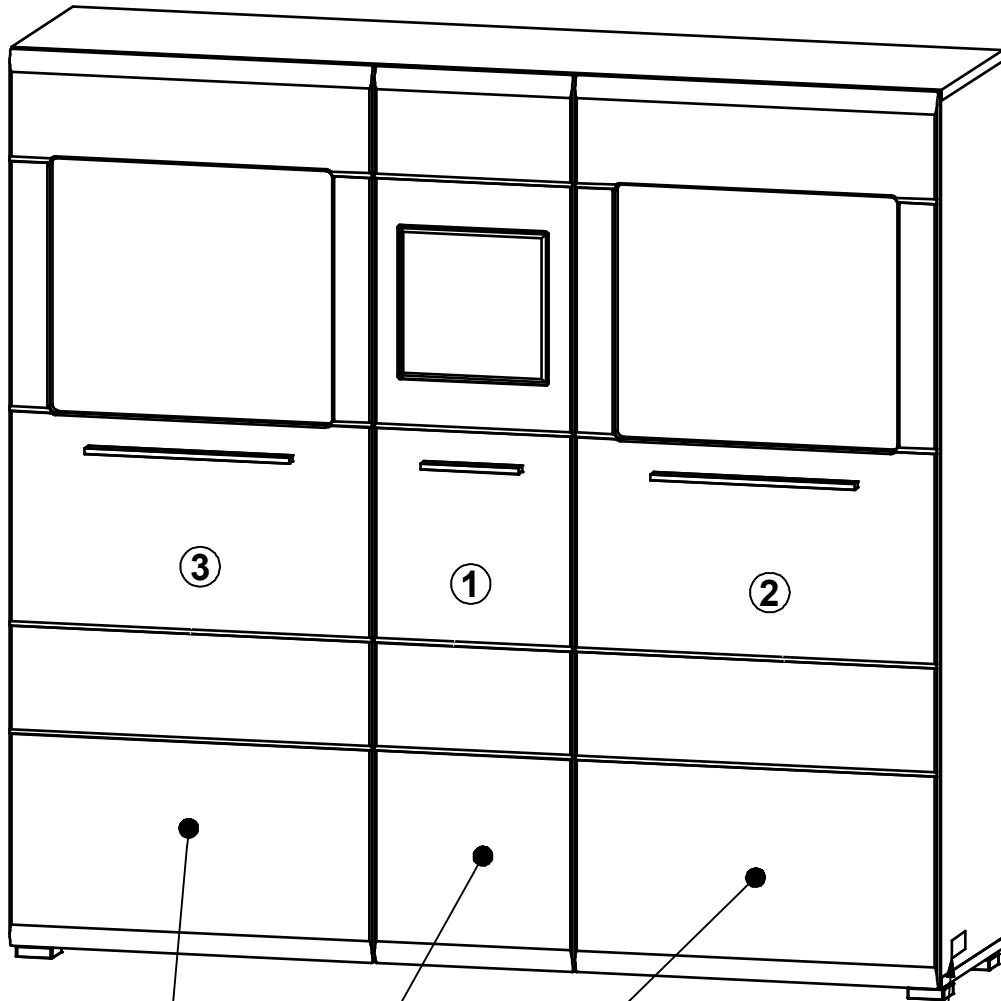

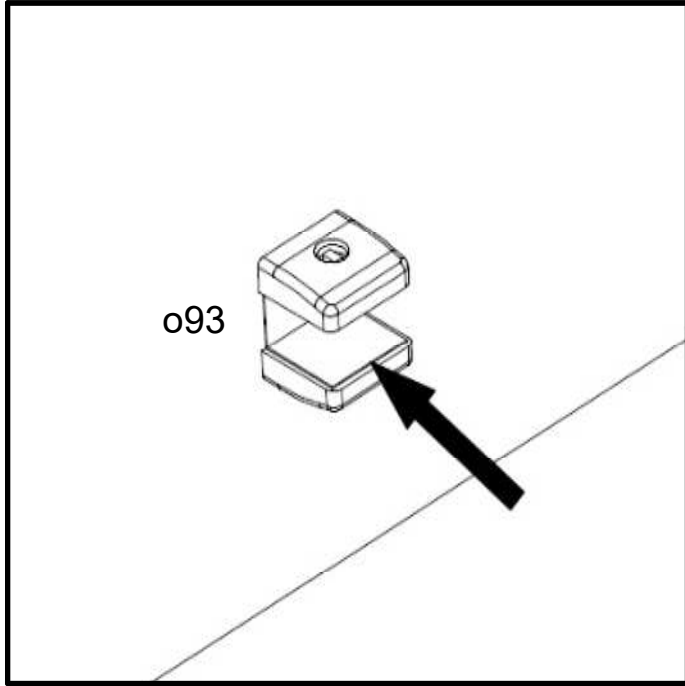

LED ZETA S 3S

