

# edy&liv

## UKKO

Art. 27357

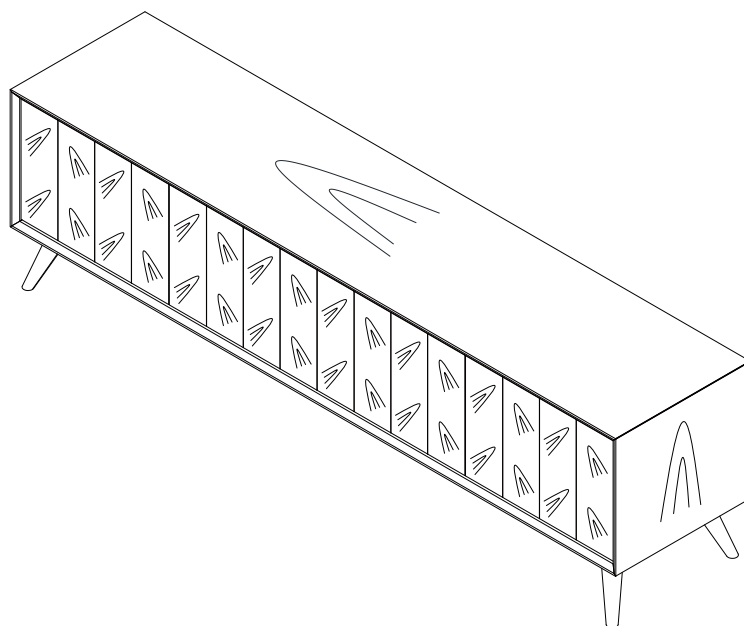

pfister.ch

### Wichtig

Anleitung vor Gebrauch sorgfältig durchlesen und für spätere Anwendung aufbewahren

### Important

Lire attentivement ce mode d'emploi avant utilisation, et le conserver pour toute consultation ultérieure

### Importante

Leggere attentamente le istruzioni prima dell'uso e conservarle per future consultazioni

### Important

Read these instructions carefully before use, and keep them safely for future reference

Version: 10.10.2025



## Warnhinweise

## Consignes de sécurité

## Avvertenze

## Warnings

### Bestimmungsgemäßer Gebrauch

Das Möbel nur dem Zweck entsprechend verwenden. Eine dauerhafte Funktionsfähigkeit ist nur durch sachgerechte Nutzung und regelmässige Unterhaltspflege gegeben.

### Usage prévu

Ce meuble doit être utilisé uniquement aux fins auxquelles il est destiné. Seuls une utilisation appropriée et un entretien régulier garantiront un usage durable.

### Uso previsto

Utilizzare il mobile secondo la finalità a cui è stato destinato. Una funzionalità duratura è garantita solo da un uso appropriato e da una cura regolare.

### Proper usage

This furniture must only be used for the intended purpose. It will serve you dependably for years, but only with appropriate usage and regular care.

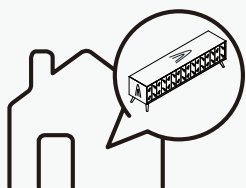

### Anwendungsort

Dieses Möbel eignet sich für den allgemeinen, privaten Wohnbereich. Es eignet sich nicht für den Nass-, Aussen- oder gewerblichen Bereich.

### Emplacement

Ce meuble est destiné à un usage en local d'habitation. Il ne convient pas pour des espaces humides, en extérieur ou commerciaux.

### Luogo di utilizzo

Questo mobile è destinato all'uso in locali residenziali privati. Non è indicato per locali umidi, all'aperto o per locali commerciali.

### Place of use

This furniture is intended for use in domestic living quarters. It is not suitable for use in wet zones, outdoors, or in commercial areas.



### WARNUNG

#### Gefahr durch Verschlucken und Ersticken!

Tüten und Folien sind kein Spielzeug! Darauf achten, dass Kleinkindern nicht an Verpackungsmaterialien, Plastiktüten und Kleinteile gelangen!

### AVERTISSEMENT

#### Risque d'ingestion et d'étouffement!

Les sachets et films plastique ne sont pas des jouets! Veiller à ce que les petits enfants n'aient pas accès aux matériaux de l'emballage, aux sacs plastique et aux petits composants!

### AVVERTIMENTO

#### Rischio di ingestione e di soffocamento!

Sacchetti e pellicole non sono giocattoli! Badare che i bambini piccoli non abbiano accesso ai materiali dell'imballaggio, ai sacchetti di plastica e ai piccoli pezzi!

### WARNING

#### Danger of swallowing and suffocation!

Bags and foils are not playthings! Keep packaging materials, plastic bags and small parts out of reach of infants!

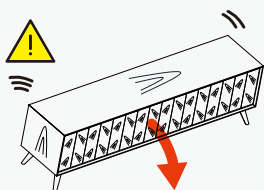

### ACHTUNG

#### Kippgefahr!

Dieses Möbel kann kippen und muss daher von einer Fachperson an Wand oder Decke befestigt werden. Die Befestigungsart ist von der Wand- oder Deckenbeschaffenheit (z.B. Beton, Gips, Backstein oder Holz) abhängig.

### ATTENTION

#### Risque de basculement!

Ce meuble est susceptible de basculer, c'est pourquoi il doit être fixé par un professionnel au mur ou au plafond. Le choix du système de fixation dépend de la consistance du mur ou du plafond (par ex. ciment, plâtre, briques ou bois).

### ATTENZIONE

#### Rischio di ribaltamento!

Questo mobile può ribaltarsi e perciò deve essere fissato alla parete o al soffitto da uno specialista. La scelta del sistema di fissaggio dipende dalla consistenza della parete o del soffitto (ad es. cemento, gesso, mattoni o legno).

### CAUTION

#### Danger of tipping!

This furniture can tip, and must therefore be professionally fastened to the wall or ceiling. The type of fastening depends on the wall or ceiling material (such as concrete, plaster, bricks or timber).

## Montagehinweise

## Instructions de montage

## Istruzioni di montaggio

## Assembly guidelines



**VORSICHT**  
**Verletzungsgefahr!**  
Darauf achten, dass sich Kleinkinder nicht im Montagebereich aufhalten und an Möbeln hochziehen bzw. hinaufklettern!

**PRÉCAUTION**  
**Risques de lésions!**  
Tenir les petits enfants hors de portée de la zone de montage et les empêcher de soulever les meubles ou de monter dessus!

**PRECAUZIONE**  
**Pericolo di lesioni!**  
Tenere i bambini piccoli fuori dall'area di montaggio e impedire loro di sollevare o di salire sui mobili!

**CAUTION**  
**Risk of injury!**  
Keep infants away from the assembly area and prevent them from mounting or climbing up furniture!

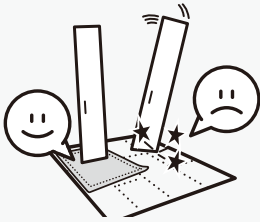

**Montageschäden verhindern**  
Einzelteile beim Auspacken und während Montage nur auf weiche Unterlagen legen/stellen. Grössere Teile vor Kippen/Umfallen sichern.

**Éviter les défauts de montage**  
Lors du déballage, déposer tous les composants sur une surface souple. Veiller à ce que les éléments de plus grande taille ne se renversent pas et ne basculent pas.

**Evitare danni di montaggio**  
Durante il disimballaggio depositare i singoli pezzi su superfici morbide. Assicurarsi che i pezzi più grandi non si rovescino o si ribaltino.

**Prevent assembly damage**  
Use a soft underlay for all parts during assembly. Secure large components from tipping or falling over.



**Personen**  
Anzahl Personen, die für die Montage benötigt werden.

**Personnes**  
Nombre de personnes nécessaires au montage.

**Persone**  
Numero di persone necessarie per il montaggio.

**Personnel**  
Number of people required for assembly work.



**Montagezeit**  
Ungefährer Zeitbedarf in Minuten.

**Temps de montage**  
Temps approximatif requis en minutes.

**Tempo di montaggio**  
Tempo approssimativo richiesto in minuti.

**Assembly time**  
Approximate time required in minutes.

## Erforderliches Werkzeug

## Outils nécessaires

## Strumenti necessari

## Tools required

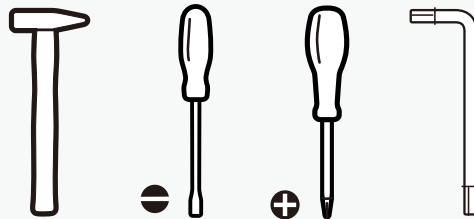

Montage-  
hinweise

Instructions de  
montage

Istruzioni di  
montaggio

Assembly  
guidelines

Möbelteile

Composants du  
meuble

Parti di mobili

Furniture compo-  
nents

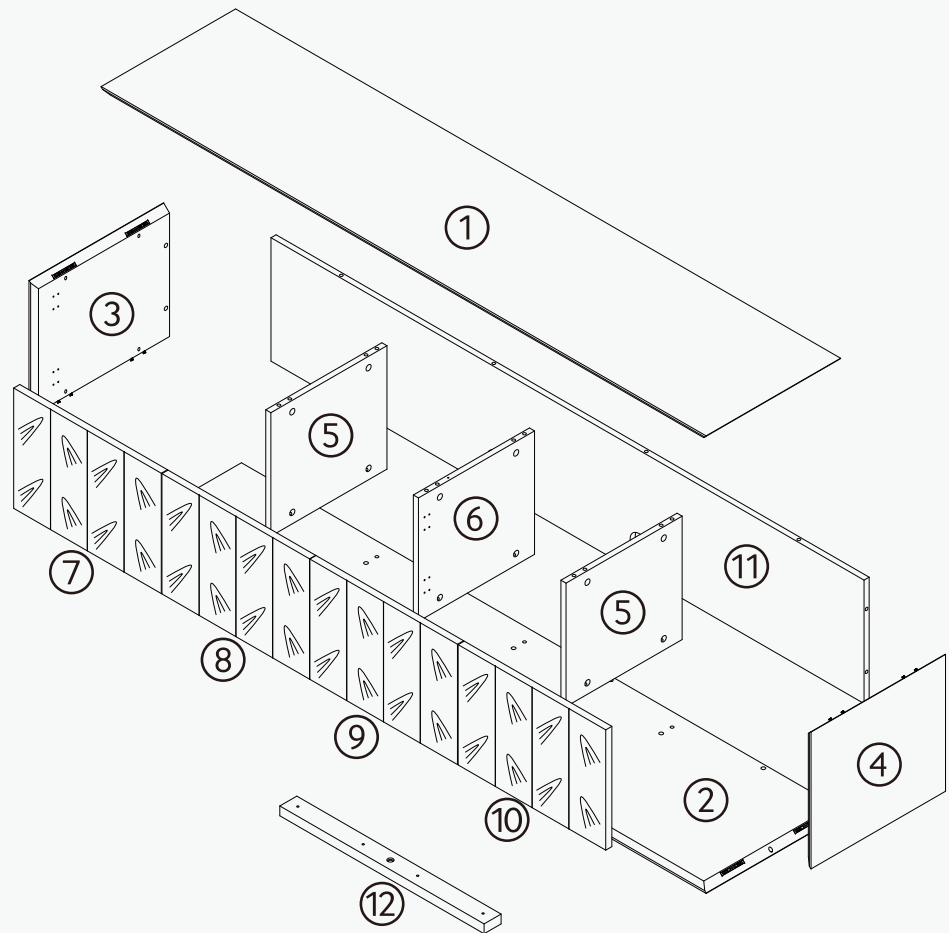

**Montage-  
hinweise**

**Instructions de  
montage**

**Istruzioni di  
montaggio**

**Assembly  
guidelines**

**Kleinteile**

**Petits éléments**

**Piccoli pezzi**

**Small parts**



**A** 12x

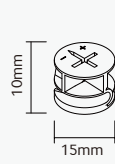

**B** 24x

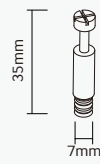

**C** 24x

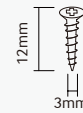

**D** 4x

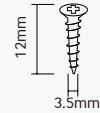

**E** 12x

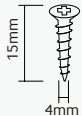

**F** 48x

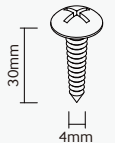

**G** 4x

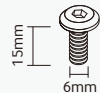

**H** 16x

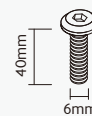

**I** 1x



**J** 2x

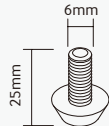

**K** 1x

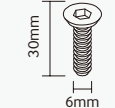

**L** 8x

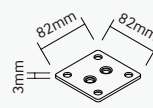

**M** 4x

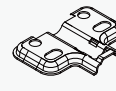

**N** 8x

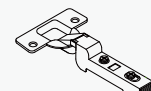

**O** 4x

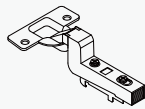

**P** 4x

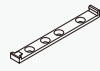

**Q** 4x

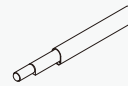

**R** 4x

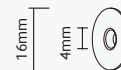

**S** 4x

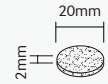

**T** 4x

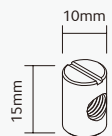

**U** 1x



**V** 12x

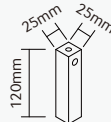

**W** 1x



**X** 4x

Montage-  
anleitung

Instructions de  
montage

Istruzioni di  
montaggio

Assembly  
instructions

1<sup>4x</sup>

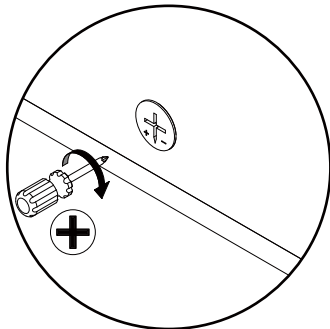
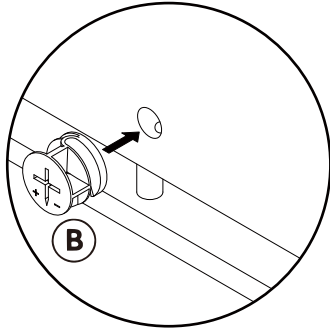
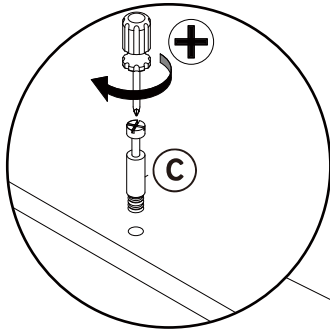

2

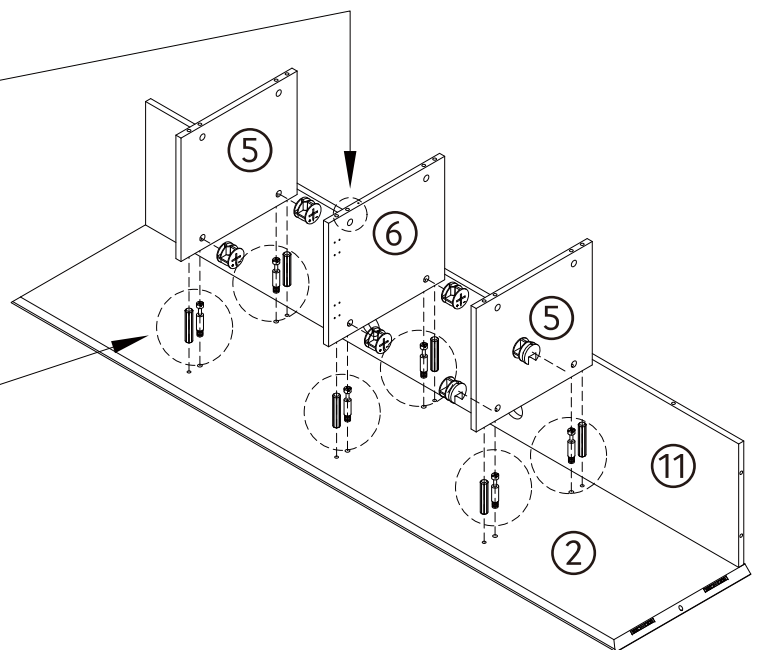
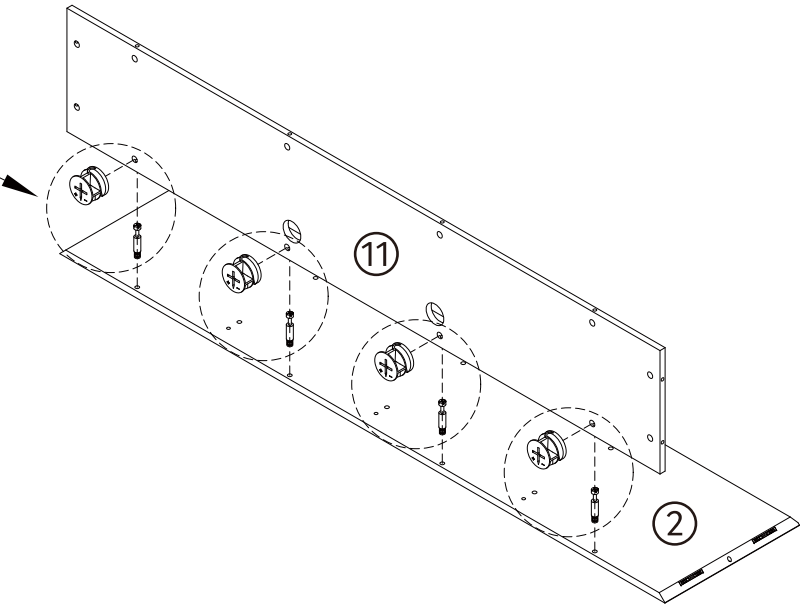
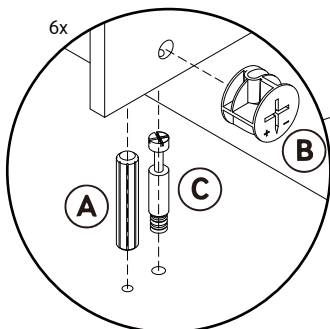
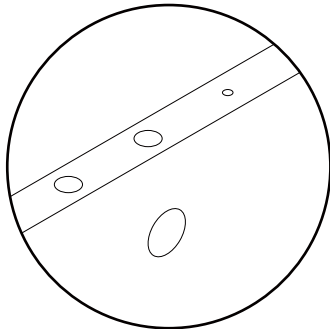

3

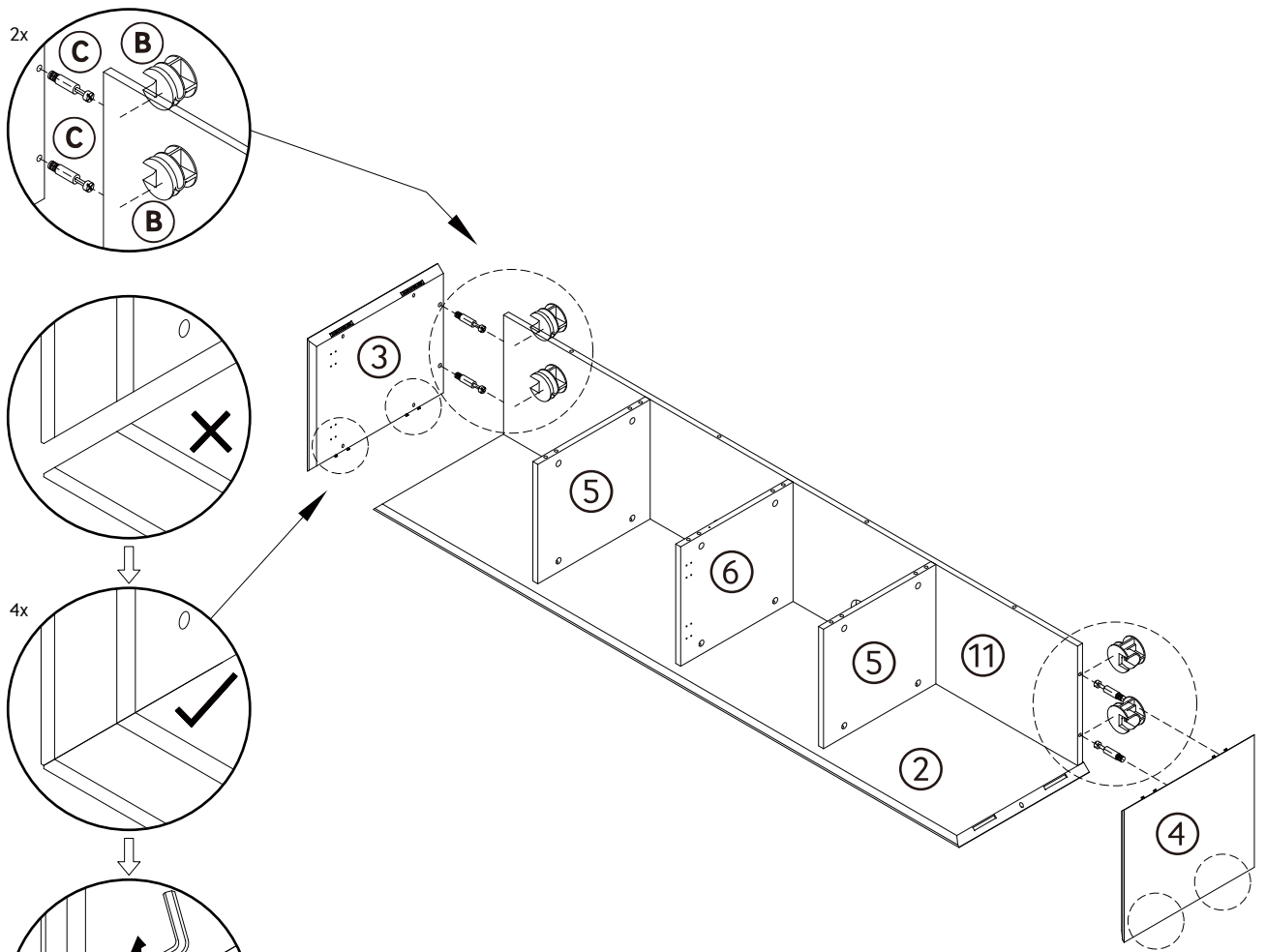

4 4x

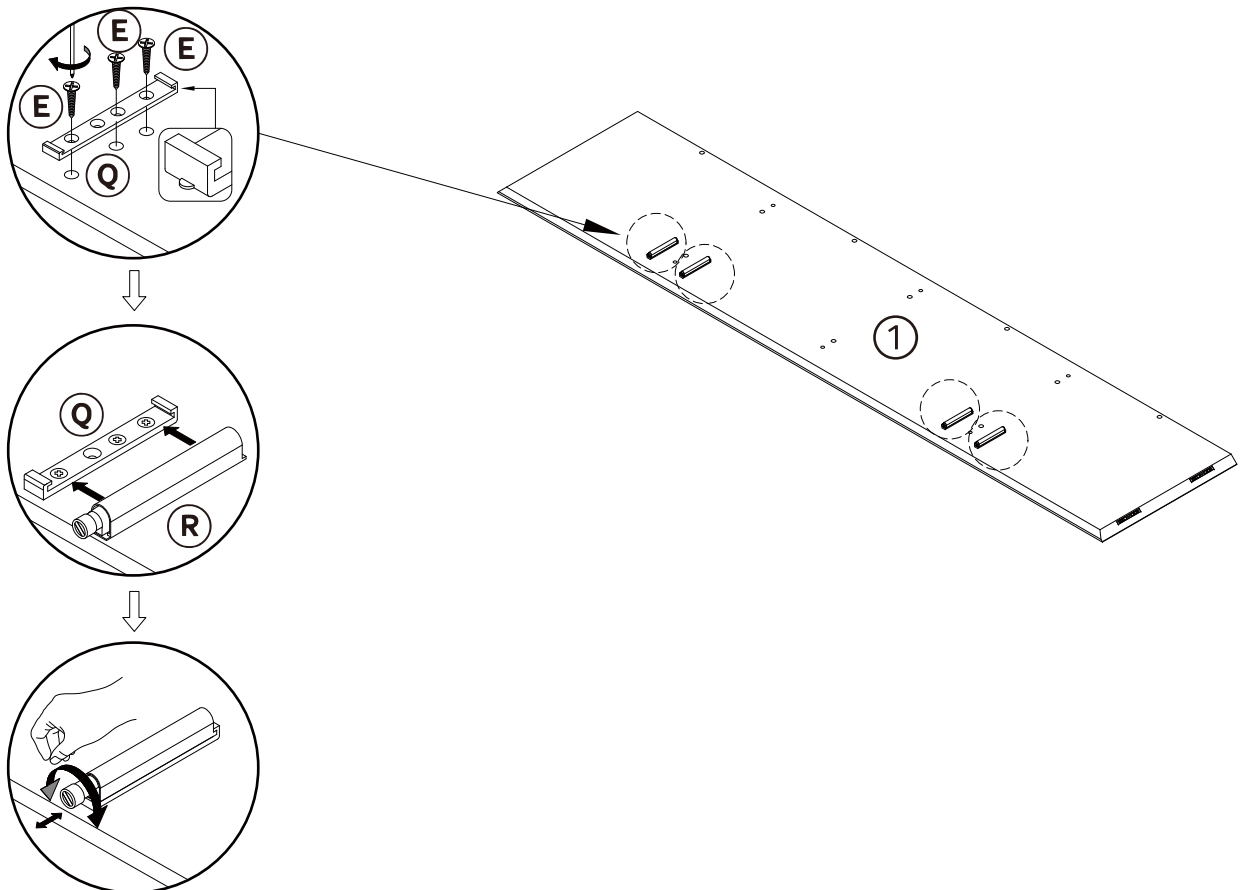

5

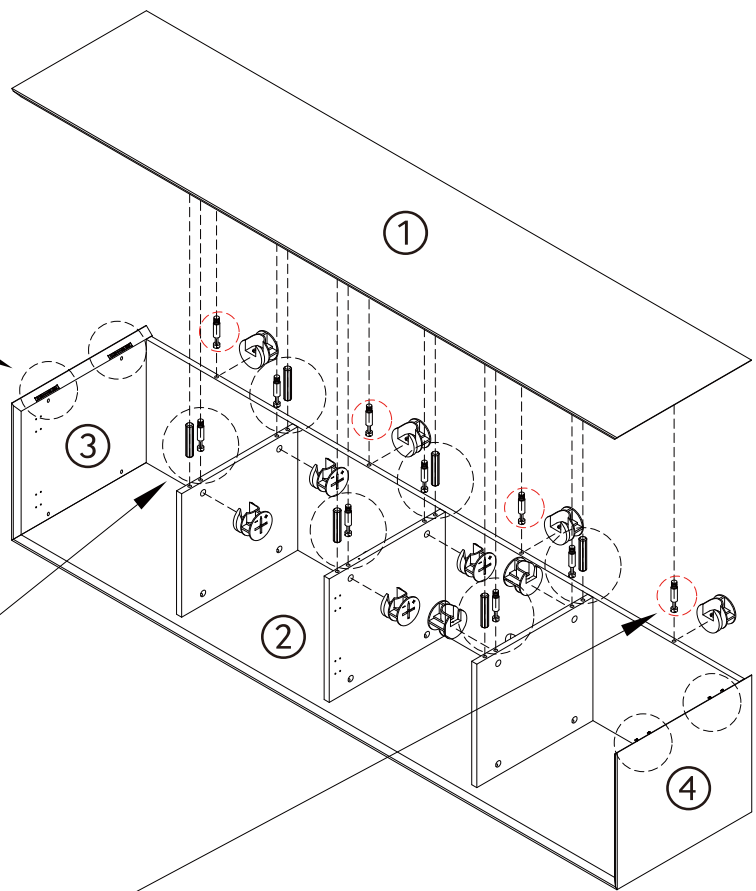
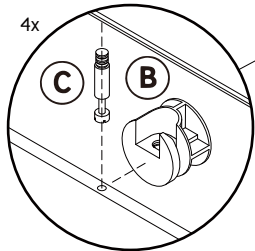
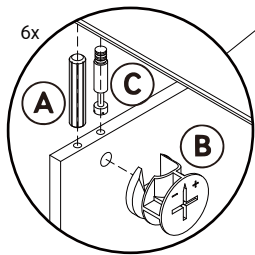
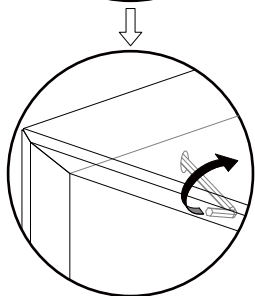
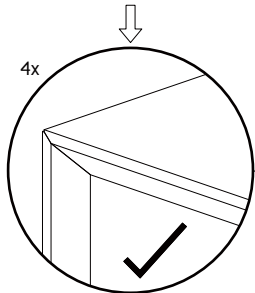
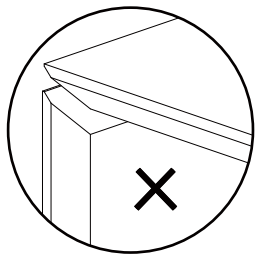

6 2x

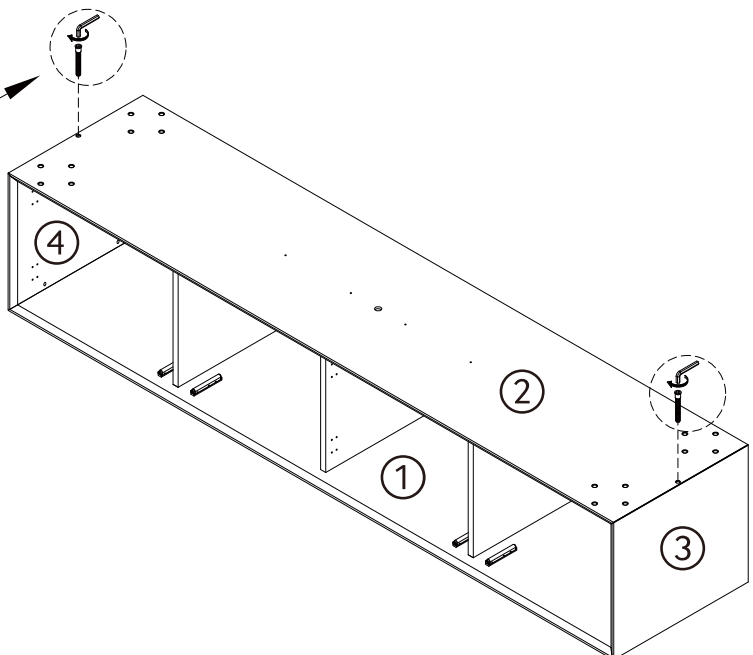
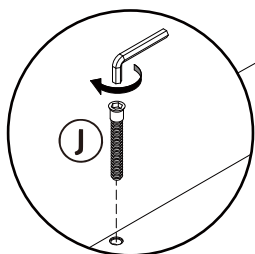

7

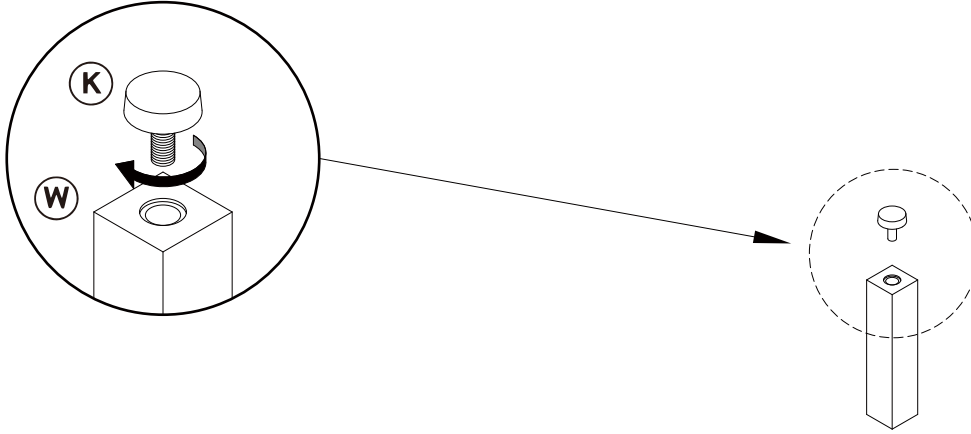

8

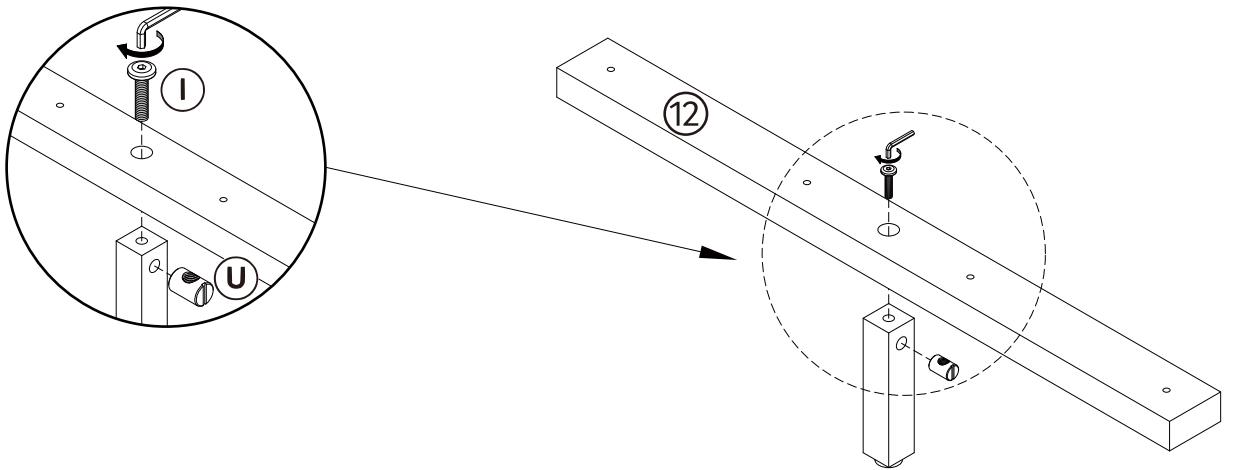

9

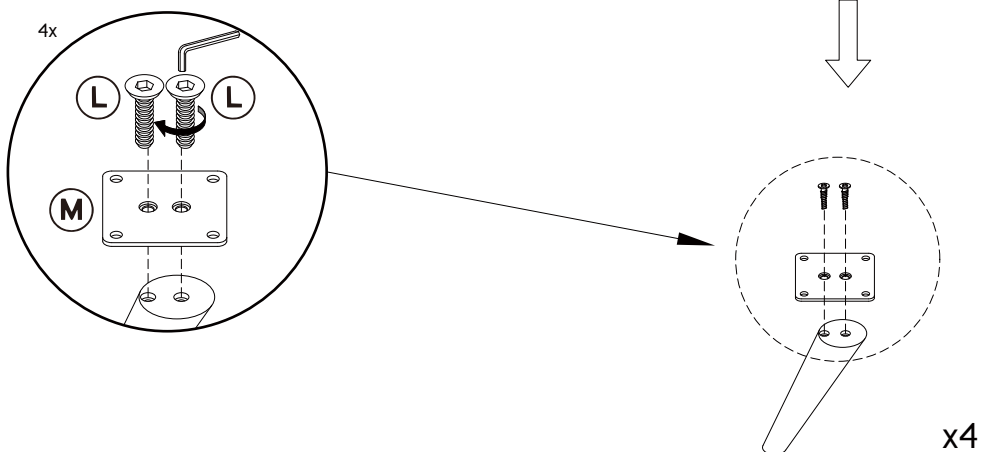
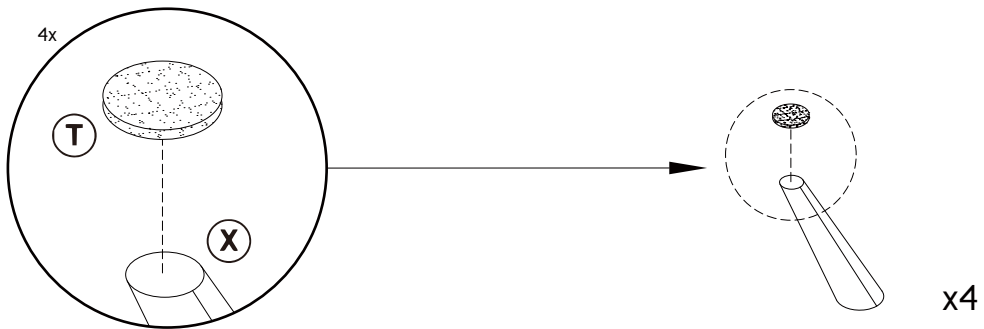

10

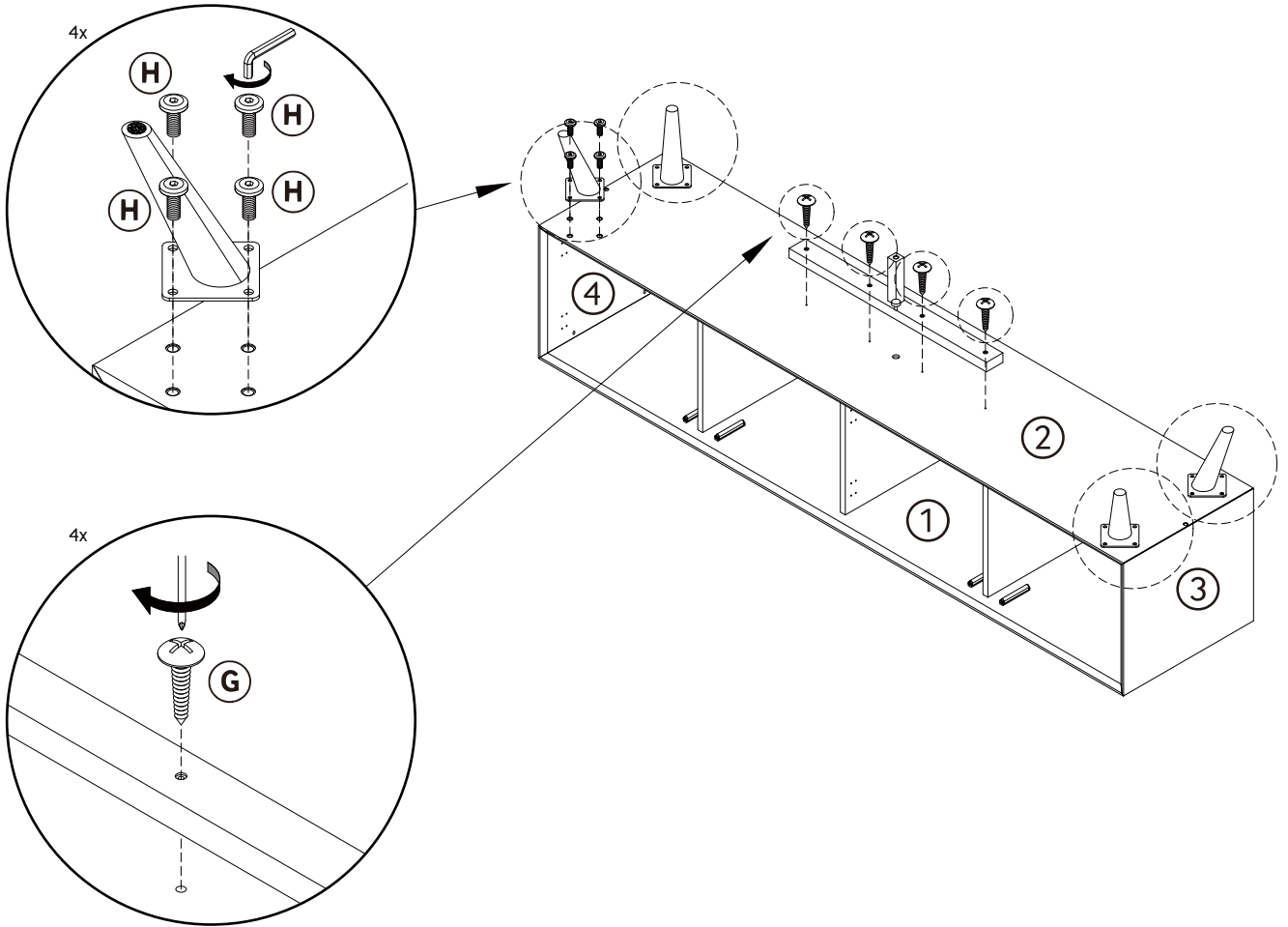

11

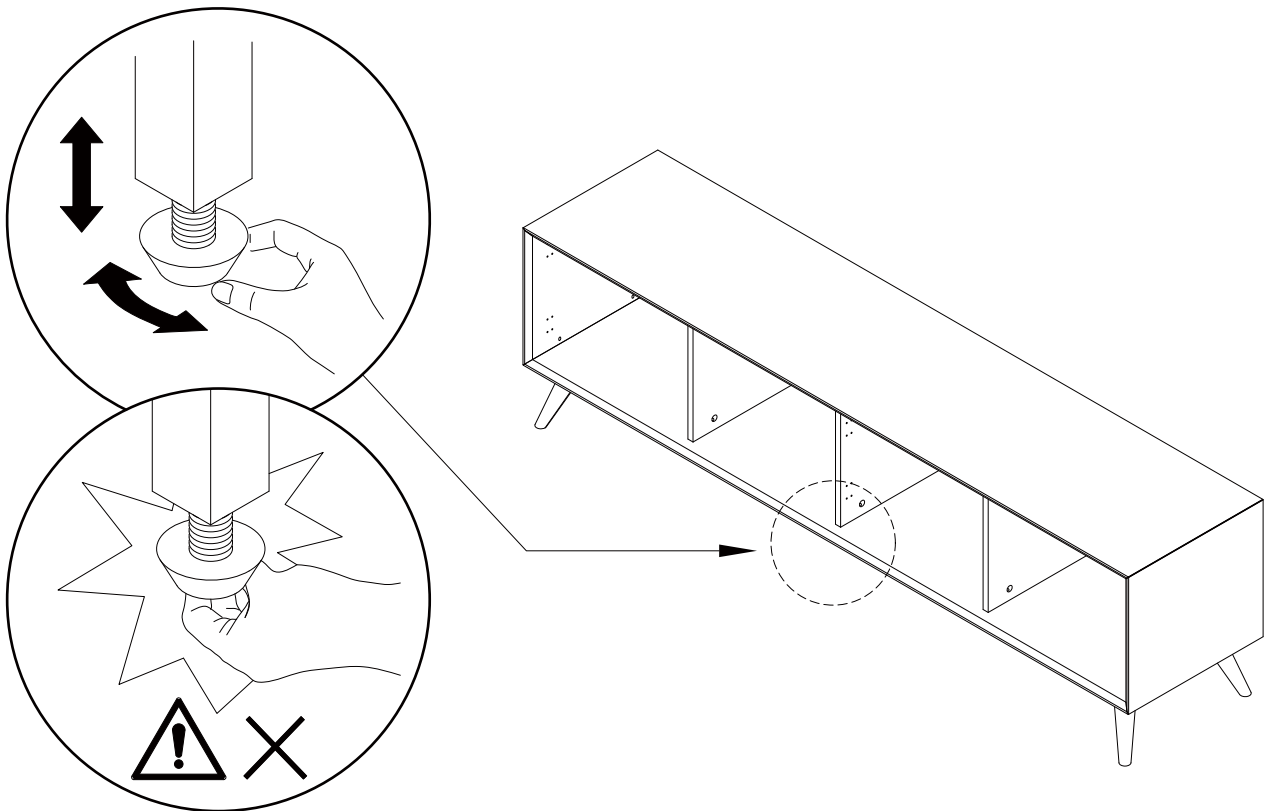

12

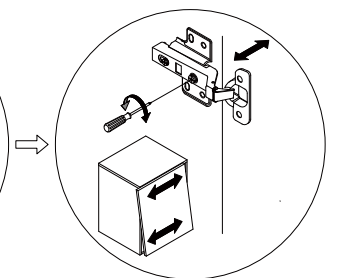
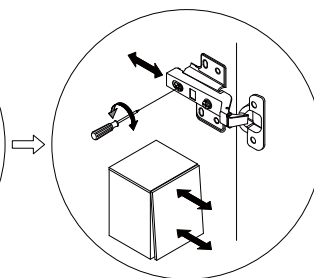
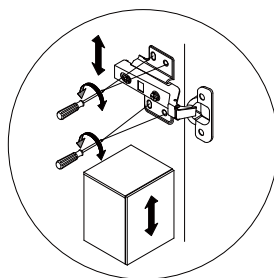
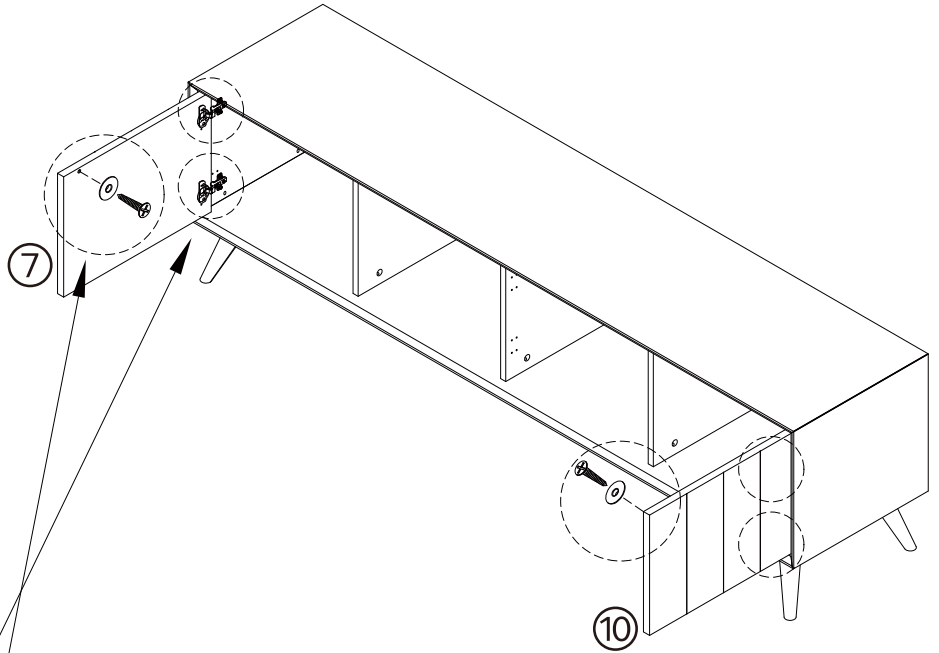
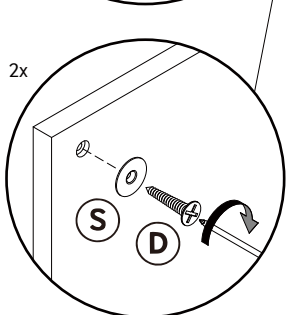
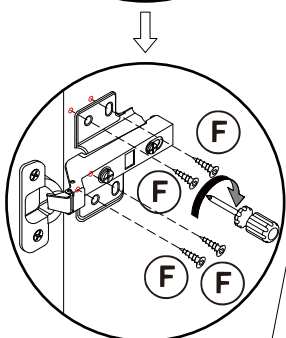
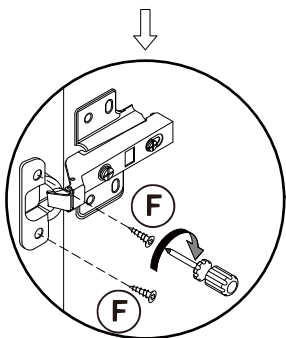
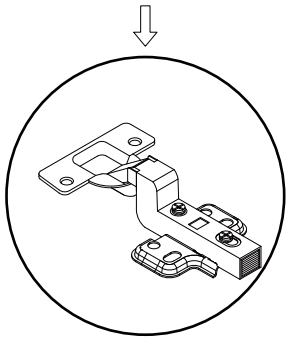
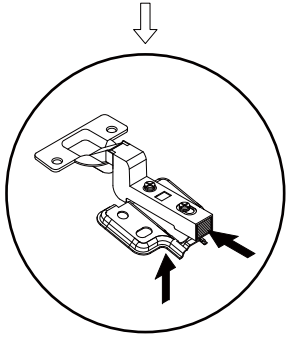
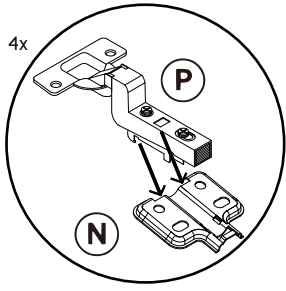

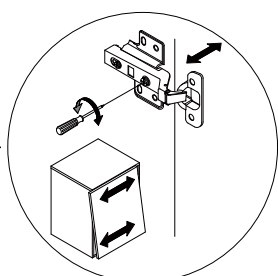
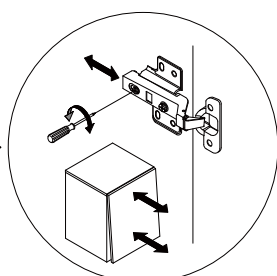
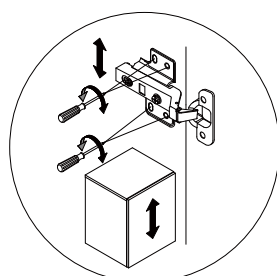
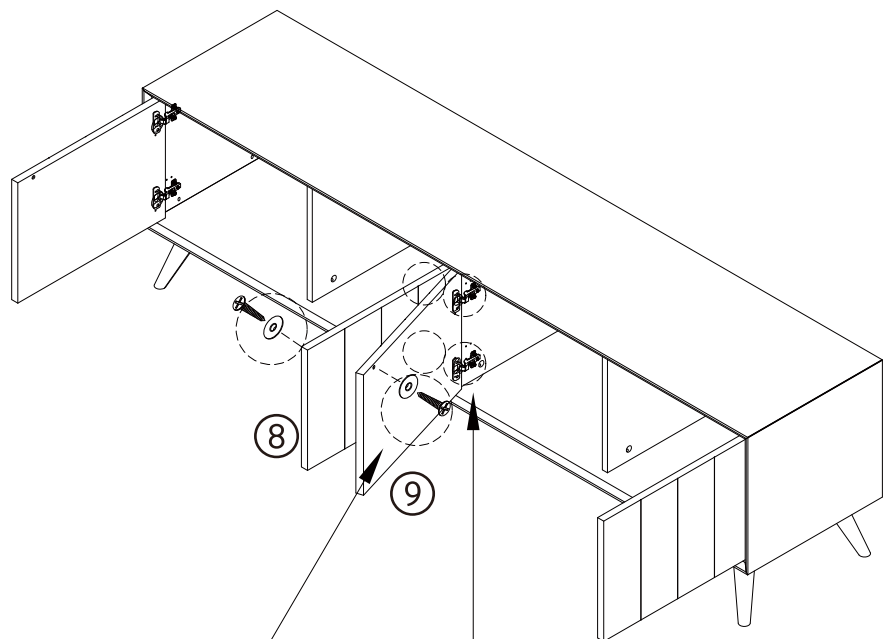
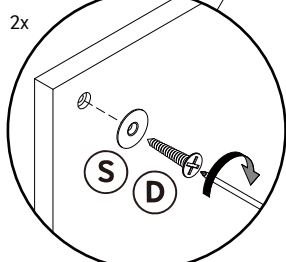
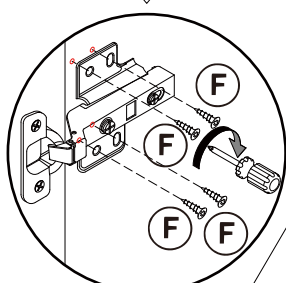
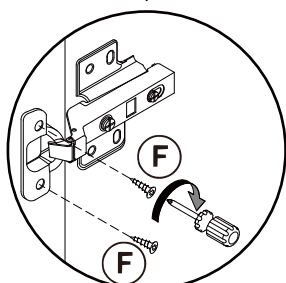
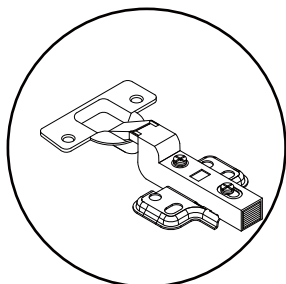
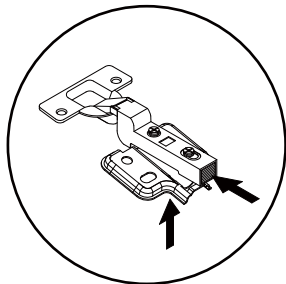
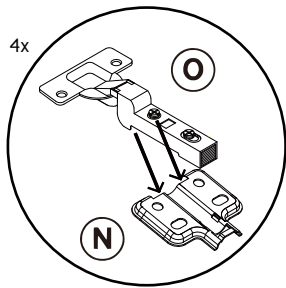

14 12x

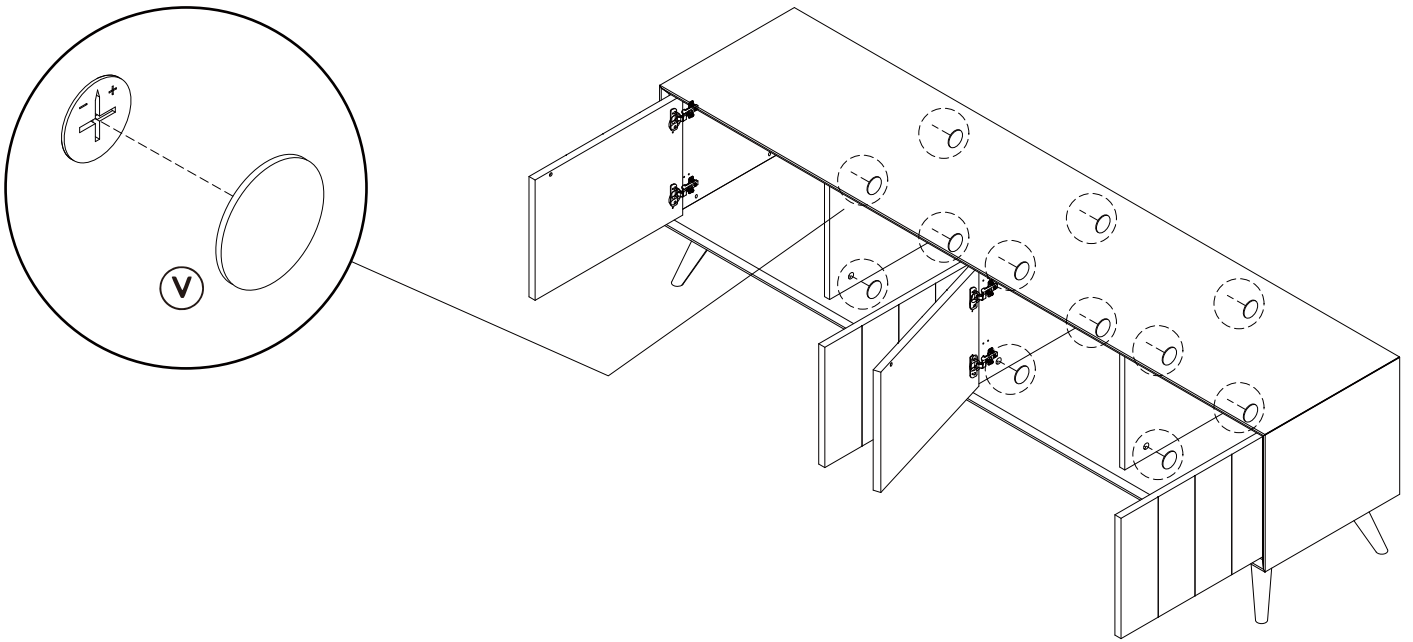

## Allgemeine Hinweise

## Indications générales

## Indicazioni generali

## General guidelines

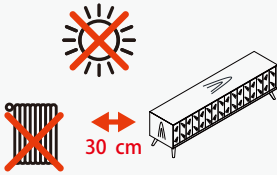

**Vermeiden Sie** direktes Sonnenlicht. Dies kann zu Farbveränderungen führen. Halten Sie mindestens 30 cm Abstand zu Heizkörpern.

**À éviter** Une exposition directe aux rayons du soleil peut entraîner une variation de la couleur. Maintenir une distance d'au moins 30 cm entre le produit et les radiateurs.

**Da evitare** L'esposizione alla luce diretta del sole può provocare cambiamenti di colore. Mantenere una distanza minima di 30 cm dai radiatori.

**To be avoided** Direct sunlight can cause colour changes. Place at least 30 cm away from heating radiators.



**Oberfläche** Pflanzentöpfe, feuchte, heiße oder sehr kalte Gegenstände nur mit Schutzunterlage auf Oberflächen stellen.

**Surfaces** Utiliser un tapis de protection pour poser sur le meuble des vases, objets humides, chauds ou très froids.

**Superficie** Utilizzare un sottopano di protezione per appoggiare sul mobile vasi, oggetti umidi, caldi o molto freddi.

**Surface protection** Always use a protective underlay for flowerpots and for any damp, hot or very cold items.

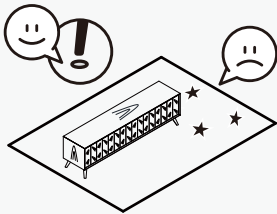

**Empfindliche Bodenbeläge** Vermeiden Sie Kratzer und Druckstellen auf empfindlichen Böden, indem Sie an Ihrem Möbel Schutzgleiter anbringen.

**Sols délicats** Monter des embouts de protection pour pieds de meuble, afin d'éviter rayures et bosses sur les sols délicats.

**Pavimenti sensibili** Montare dei piedini protettivi per mobili, onde evitare graffi e ammaccature sui pavimenti sensibili.

**Sensitive flooring** Fit protective glides to your furniture to prevent scratching or denting sensitive flooring.

## Pflege

## Entretien

## Cura

## Care



Unter [www.pfister.ch/de/service](http://www.pfister.ch/de/service) finden Sie unseren detaillierten Pflegeanleitung.

Sur le site [www.pfister.ch/fr/service](http://www.pfister.ch/fr/service) vous trouverez des conseils détaillés pour l'entretien du produit.

Sul sito [www.pfister.ch/it/service](http://www.pfister.ch/it/service) sono disponibili le nostre raccomandazioni dettagliate per la cura del prodotto.

At [www.pfister.ch/de/service](http://www.pfister.ch/de/service) you can find our detailed recommendations for care and maintenance.

## Wartung

## Maintenance

## Manutenzione

## Maintenance



### Schrauben

Schrauben regelmässig nachziehen (z.B. halbjährlich), um eine einwandfreie, zuverlässige Funktion zu gewährleisten.

### Vis & boulons

Resserrer régulièrement les vis et boulons (par ex. tous les 6 mois) pour garantir une utilisation fiable et impeccable du produit.

### Viti & bulloni

Stringere regolarmente viti e bulloni (ad es. ogni 6 mesi) per garantire una funzionalità affidabile e impeccabile.

### Screws and bolts

Screws and bolts should be regularly tightened (e.g. every six months) to ensure faultless dependability.

### Bänder

Bänder regelmässig kontrollieren (ca. halbjährlich) und falls nötig neu einstellen.

### Charnières

Contrôler régulièrement les charnières (par ex. tous les 6 mois). Les régler de nouveau si nécessaire.

### Cerniere

Controllare regolarmente le cerniere (ad es. ogni 6 mesi). Regolarle di nuovo se necessario.

### Straps

Straps should be regularly checked for tightness (e.g. every six months) and adjusted accordingly if necessary.

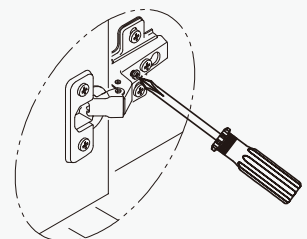
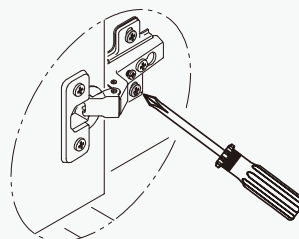
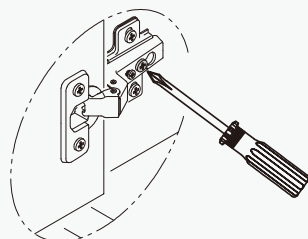
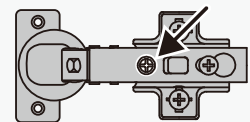
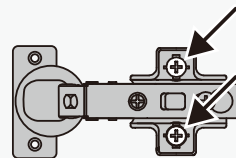
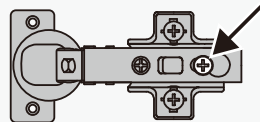
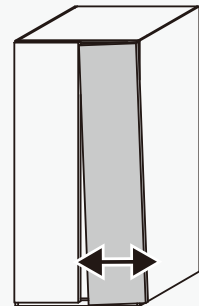
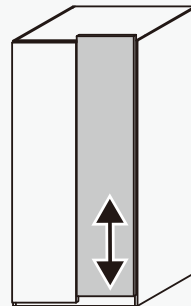
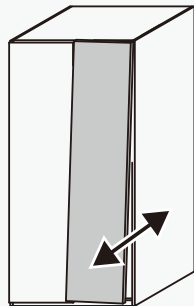

## Entsorgung

## Élimination

## Smaltimento

## Disposal



### Entsorgung

Möbel, die nicht mehr verwendet werden, der fachgerechten Entsorgung übergeben. Wenden Sie sich an Ihre lokale Entsorgungsstelle.

### Élimination

Tout meuble inutilisé doit être éliminé correctement. S'adresser à un centre de recyclage pour l'élimination des déchets.

### Smaltimento

Smaltire correttamente i mobili non più utilizzati. Rivolgersi al proprio ecocentro per lo smaltimento dei rifiuti.

### Disposal

Furniture that cannot be repaired or has reached the end of its useful life should be handed over for professional disposal. Please contact your local waste disposal authority.

## Pfister - Kontaktcenter

## Centre de contact Pfister

## Centro di contatto Pfister

## Pfister Contact Centre

## Hotline

### Fragen

Wir sind gerne für Sie erreichbar:  
**062 855 33 33**

Montag bis Freitag  
08:00 bis 17:30

### Ersatzteile

Bitte melden Sie sich in Ihrer Filiale oder rufen Sie unsere Hotline an.

### Questions

Nous sommes à votre disposition:  
**062 855 33 44**

du lundi au vendredi  
de 08:00 à 17:30

### Pièces de rechange

Adressez-vous à votre filiale ou contactez notre hotline.

### Domande

Restiamo volentieri a sua disposizione:  
**062 855 33 55**

da lunedì a venerdì  
dalle 08:00 alle 17:30

### Pezzi di ricambio

Contatti la sua filiale oppure chiami la nostra hotline.

### Questions and queries

We are at your service as follows:  
**062 855 33 33**

Monday to Friday from  
08:00 until 17:30

### Replacement parts

Please contact your nearest store, or call our hotline.